

**SAUNDERS**  
ELSEVIER

An imprint of Elsevier Limited

© Elsevier Limited 2007. All rights reserved.

No part of this publication may be reproduced, stored in a retrieval system, or transmitted in any form or by any means, electronic, mechanical, photocopying, recording or otherwise, without the prior permission of the Publishers. Permissions may be sought directly from Elsevier's Health Sciences Rights Department, 1600 John F. Kennedy Boulevard, Suite 1800, Philadelphia, PA 19103-2899, USA; phone: (+1) 215 239 3804; fax: (+1) 215 239 3805; or, e-mail: [healthpermissions@elsevier.com](mailto:healthpermissions@elsevier.com). You may also complete your request on-line via the Elsevier homepage (<http://www.elsevier.com>), by selecting 'Support and contact' and then 'Copyright and Permission'.

First published 2007

ISBN-13: 978 0 7020 2780 2

**British Library Cataloguing in Publication Data**

A catalogue record for this book is available from the British Library

**Library of Congress Cataloging in Publication Data**

A catalog record for this book is available from the Library of Congress

**Notice**

Knowledge and best practice in this field are constantly changing. As new research and experience broaden our knowledge, changes in practice, treatment and drug therapy may become necessary or appropriate. Readers are advised to check the most current information provided (i) on procedures featured or (ii) by the manufacturer of each product to be administered, to verify the recommended dose or formula, the method and duration of administration, and contraindications. It is the responsibility of the practitioner, relying on their own experience and knowledge of the patient, to make diagnoses, to determine dosages and the best treatment for each individual patient, and to take all appropriate safety precautions. To the fullest extent of the law, neither the Publisher nor the Authors assume any liability for any injury and/or damage to persons or property arising out or related to any use of the material contained in this book.

**The Publisher**

**ELSEVIER** your source for books,  
journals and multimedia  
in the health sciences  
[www.elsevierhealth.com](http://www.elsevierhealth.com)

Working together to grow  
libraries in developing countries  
[www.elsevier.com](http://www.elsevier.com) | [www.bookaid.org](http://www.bookaid.org) | [www.sabre.org](http://www.sabre.org)  
**ELSEVIER** **BOOK AID** **Sabre Foundation**  
International

The  
publisher's  
policy is to use  
paper manufactured  
from sustainable forests

Printed in China

## Acknowledgements

In the writing this book, I have been helped and encouraged by three dear colleagues namely, Alberto Brizzi, Christer Bergsten and Christoph Mülling. After I had written each chapter they commented on my ideas and added their own. In many instances they influenced my perspective on some topics and somewhat surprisingly there were no conflicts of opinion that were not easily resolved. I believe, therefore, that the book represents a consensus of our opinions. I must express my deepest appreciation and thanks to these three colleagues and friends.

I have also been privileged to have the support of a number of colleagues who have read one or more chapters of the book. Mike Socha offered many suggestions that improved the quality of the chapters on nutrition, water, minerals and management of replacement animals. Jakob Malmo, Charlotte Westwood and Pablo Chilibroste helped bring the chapter on pasture management of dairy cows into perspective with practices in the Southern Hemisphere. Jacques Chesnais commented on the chapter on genetic selection and prompted me to rewrite that part of the manuscript and to express very different information which probably does not reflect his personal standpoint. To all of these individuals I am also extremely grateful.

This book contains photographs contributed by 32 colleagues from 15 different countries. I have been impressed by the enthusiasm with which so many individuals around the world have offered this assistance. For this they have my appreciative thanks. Every effort has been made to identify the copyright holders of the images in my collection. Please contact me or the publisher if any omissions have been made.

I am also grateful to those many colleagues who by contributing to the literature have inspired many of the ideas that are presented in this text. The literature sometimes offers conflicting facts or proposes concepts that are difficult to integrate into our present thinking. We have avoided referencing our text for the sake of clarity and have offered a bibliography at the end of each chapter for those wishing further reading.

I would like to express my gratitude to Ken Nordlund for the unenviable task of reading the proofs and writing the Foreword to this book.

I must also express my gratitude to Joyce Rodenhuis, Commissioning Editor for Elsevier Health Sciences for her confidence in supporting a new concept and her encouragement to embark on the production of this work. I also

## **viii** Acknowledgements

appreciate the patience and care taken by Rita Demetriou-Swanwick, Associate Editor for Elsevier in bringing about harmony between text and layout with such an artistic flair.

Finally, I must acknowledge the meticulous services of an outstanding proof reader, my wife Sharon. She patiently weaned me away from complicated descriptions and explanation and held me to my objective of using simple language.

I have been influenced by many individuals in creating this book. The privilege of a lifetime working with farmers and their cattle has given me a treasured memory databank of the reality of lameness problems. For this I am most grateful of all.

Paul Greenough

## Consulting Editors

### **Dr Christer Bergsten DVM, PhD**

Assistant Professor  
Department of Animal Environment  
and Health  
Swedish University of Agricultural  
Sciences  
Skara, Sweden

### **Dr Alberto Brizzi DVM**

Private Practitioner  
Parma, Italy

### **Dr Christoph K W Mülling DVM**

Veterinary Specialist in Anatomy  
Assistant Professor, Department of  
Veterinary Anatomy  
Freie Universität Berlin  
Berlin, Germany

## Contributors

### **Roberto Acuña**

Private practitioner  
Florida, Uruguay

### **Uri Bargai**

Emeritus of Radiology  
Koret School of Veterinary Medicine  
Rehovot, Israel

### **R. Boosemann**

Dierenkliniek Noord-Nederland  
Veendam, The Netherlands

### **Karl Burgi**

Program Director and Instructor  
Dairyland Hoof Care Institute  
Baraboo, Wisconsin  
USA

### **James Ferguson**

Professor of Surgery  
Chirurgischen Tierklinik  
Universität Leipzig  
Germany

### **Adrián González Sagüés**

Director  
Técnico del Grupo ANKA  
Cuidado de pezuñas  
Pamplona, Spain

### **Arie Hamoen**

Chairman  
Working Group for Functional  
Conformation Traits  
World Holstein-Friesian Federation  
The Netherlands

### **Ruth M. Hirschberg**

Institut für Veterinär Anatomie,  
Fachbereich Veterinärmedizin  
Freie Universität Berlin  
Berlin, Germany

### **Eugene D. Janzen**

Associate Dean Clinical Planning  
Faculty of Veterinary Medicine  
University of Calgary  
Calgary, Alberta  
Canada

### **Gordon Jones**

Director  
Dairy Herd Performance  
Fair Oaks Dairy Farms, Continental Milk  
Producers  
Wheatfield, Indiana  
USA

### **Geoff Laurant**

President  
Shoof International Ltd  
Cambridge, New Zealand

### **Cristoph Lischer**

Professor of Equine Clinical Studies  
Weipers Centre for Equine Welfare  
Division of Veterinary Companion  
Animal Sciences  
University of Glasgow Veterinary  
School  
Glasgow, Scotland  
UK

## Consulting Editors

### **Dr Christer Bergsten DVM, PhD**

Assistant Professor  
Department of Animal Environment  
and Health  
Swedish University of Agricultural  
Sciences  
Skara, Sweden

### **Dr Alberto Brizzi DVM**

Private Practitioner  
Parma, Italy

### **Dr Christoph K W Mülling DVM**

Veterinary Specialist in Anatomy  
Assistant Professor, Department of  
Veterinary Anatomy  
Freie Universität Berlin  
Berlin, Germany

## Contributors

### **Roberto Acuña**

Private practitioner  
Florida, Uruguay

### **Uri Bargai**

Emeritus of Radiology  
Koret School of Veterinary Medicine  
Rehovot, Israel

### **R. Boosemann**

Dierenkliniek Noord-Nederland  
Veendam, The Netherlands

### **Karl Burgi**

Program Director and Instructor  
Dairyland Hoof Care Institute  
Baraboo, Wisconsin  
USA

### **James Ferguson**

Professor of Surgery  
Chirurgischen Tierklinik  
Universität Leipzig  
Germany

### **Adrián González Sagüés**

Director  
Técnico del Grupo ANKA  
Cuidado de pezuñas  
Pamplona, Spain

### **Arie Hamoen**

Chairman  
Working Group for Functional  
Conformation Traits  
World Holstein-Friesian Federation  
The Netherlands

### **Ruth M. Hirschberg**

Institut für Veterinär Anatomie,  
Fachbereich Veterinärmedizin  
Freie Universität Berlin  
Berlin, Germany

### **Eugene D. Janzen**

Associate Dean Clinical Planning  
Faculty of Veterinary Medicine  
University of Calgary  
Calgary, Alberta  
Canada

### **Gordon Jones**

Director  
Dairy Herd Performance  
Fair Oaks Dairy Farms, Continental Milk  
Producers  
Wheatfield, Indiana  
USA

### **Geoff Laurant**

President  
Shoof International Ltd  
Cambridge, New Zealand

### **Cristoph Lischer**

Professor of Equine Clinical Studies  
Weipers Centre for Equine Welfare  
Division of Veterinary Companion  
Animal Sciences  
University of Glasgow Veterinary  
School  
Glasgow, Scotland  
UK

**x** Consulting Editors and Contributors

**Jakob Malmo**

Registered Veterinary Specialist in  
Veterinary Medicine  
Cattle Medicine  
Maffra Veterinary Centre  
Maffra, Victoria  
Australia

**Dale Miskimins**

Animal Disease Research and Disease  
Laboratory  
South Dakota State University  
Brookings, South Dakota  
USA

**Carlo Maria Mortellaro**

Professor  
Department of Veterinary Clinical  
Sciences  
Division of Surgery  
Faculty of Veterinary Medicine  
University of Milan  
Milan, Italy

**Karen Mortensen**

Rineg, Denmark

**Kerstin Mueller**

Professor  
Klinik für Klaurmtiere  
Freie Universität Berlin  
Berlin, Germany

**Jonathan Naylor**

Professor  
Large Animal Clinical Sciences  
Western College of Veterinary Medicine  
52 Campus Drive  
Saskatoon, Saskatchewan  
Canada

**Ken Nordlund**

Clinical Professor of Food Animal  
Production Medicine  
University of Wisconsin-Madison  
School of Veterinary Medicine  
Madison, Wisconsin  
USA

**Garrett R. Oetzel**

Associate Professor  
Department of Medical Sciences  
School of Veterinary Medicine  
Madison, Wisconsin  
USA

**Pete Ossent**

Professor  
Department of Veterinary Pathology  
University of Zurich  
Zurich, Switzerland

**Greg Penner**

College of Agriculture  
University of Saskatchewan  
Saskatoon, Saskatchewan  
Canada

**Randy Shaver**

Professor and Extension Dairy  
Nutritionist  
Department of Dairy Science  
College of Agriculture and Life Sciences  
University of Wisconsin  
Madison, Wisconsin  
USA

**Mike Socha**

ZINPRO Corporation  
Eden Prairie, Minnesota  
USA

**Mike Stable**

Bolton Manor Farm  
Little Urswick  
Ulverston, Cumbria  
UK

**Bimbo Welker**

Director and Professor  
Large Animal Clinics  
Ohio State University  
Marysville, Ohio  
USA

**Jan-Willem Wopereis**

Rector  
Hulshofstraat 10 7135 JV  
Harreveld, The Netherlands

**Kazuhiro Yoshino**

Akabane Animal Clinic  
Akabane  
Tahara, Aichi  
Japan

## Foreword

When Professor Greenough invited me to write a foreword to this book, I assumed it to be a new edition of his *Lameness in Cattle* which had already reached its third edition in 1997. It was not until the proofs arrived that I noticed the new title *Bovine Laminitis and Lameness* and realized that it was an entirely new text. Book titles do not change by accident, so I took some moments to explore both the prior books and the pages of this new text.

Why had laminitis been elevated into a title role? I went to my bookshelf and found my copy of the first edition of *Lameness in Cattle*, published in 1972. I located laminitis under a section entitled Metabolic Diseases and found the entries 'acute' and 'chronic' laminitis discussed in less than ten pages. There are histological photographs of thrombi in vessels of the corium. There is a picture of a cow with a familiar arched back. However, it is both humorous and gratifying to read the entire discussion of the prevention of laminitis in a single sentence: *'Little may be possible in the way of prevention if the cause is associated with metritis or retained fetal membranes or a particular intensive fattening system except where a particular foodstuff, such as wheat bran or oilseed cake, is incriminated.'* Ten pages on laminitis and one sentence on prevention! As I turned to this new book, I found over a hundred pages on laminitis and those pages are dominated by discussions of risk factors for laminitis. Gratified to realize the profound expansion of knowledge in this area, I concluded that the elevation of laminitis into the title was appropriate.

The intervening 35 years have also seen the emergence of the 'herd' as a unit of interest by the veterinary profession and this book reflects that growth. We still characterize a hoof as normal or abnormal based upon the appearance of lesions, but we now characterize the herd as normal or abnormal based upon the prevalence of specific problems. In treating the herd, our interventions are as likely to be focused on housing, rations, foot bath concentrations, or track management as on the cows themselves. While herd-level risk factors and preventive interventions are a major focus of this book, the fundamental core of veterinary practice and this book remains that of making an informed diagnosis of the individual animal problem. The terminology, photographs, and discussions of specific lesions should quickly establish this book as the current standard textbook on bovine lameness. On reflection, I believe that the quality of discussion that extends across both specific lesions and herd interventions is perhaps unique and is the greatest strength of this text.

Several features make these pages very friendly to readers. In color-coded blocks within each chapter, you will find a Glossary, Key Concepts, and Technical Comments that stand out for convenience. Understanding that most users of this textbook will not read it cover to cover, but will instead search through individual chapters for answers to specific questions, Professor Greenough has repeated many of the key concepts in related locations throughout the book. Because literature citations make for disrupted sentences, they are not offered within the text itself. Should additional information be desired, a list of references is provided at the end of each chapter. Finally, the inclusion of color photographs brings new clarity to the many illustrations of hoof lesions to be found in these pages.

I would like to close with some personal comments about Professor Greenough. I have been a veterinarian for 30 years. Within a few months after entering practice, I purchased a copy of the little green first edition of *Bovine Lameness* because it had become self-evident that my training on lameness in veterinary college had been insufficient. That edition served me well for several years. In the early 1980s, I recall driving to the Minnesota Herd Health Programming Conference in St. Paul because Paul Greenough was scheduled to present a series of lectures. As he finished the presentations, I stood in a queue of people with questions. I held a handful of photographs of hoof lesions from one of my client's herds and sought his opinion. I still recall how he examined the pictures, sat down to discuss the history of the herd, and offered pointed advice that opened to me a dawning awareness of the relationship between ruminal acidosis and the lesions I had photographed. Other contributions continued to arrive over the subsequent decades. For at least 40 years, Professor Greenough has occupied a position as the central authority on bovine lameness in North America, collecting and advancing our knowledge, serving our profession and the cattle industries, and advocating for animal welfare. On behalf of the hundreds or perhaps thousands of veterinarians who have improved their services to cows and their owners because of his career, I say thank you to Professor Paul Greenough.

Ken Nordlund, DVM  
January 2007



## Introduction

### GLOSSARY

**Lameness:** Modification of gait; a clinical sign of many diseases and disorders.

**Disease:** A sickness caused by an infectious agent.

**Disorder:** A sickness resulting from an accident or a failure in body function.

**Risk factor:** Any stressful circumstance making an animal more prone to lameness.

**Insult:** The point in time when a risk factor negatively affects an animal.

### KEY CONCEPTS

*'The veterinary practitioner faced with a herd lameness problem on a farm needs to examine farm management rather than merely treating a long series of individual cases'* (Chesterton)

- Lameness is a clinical sign and should not be regarded as a disease or disorder.
- Risk factors affecting the incidence of lameness also affect the incidence of other conditions, such as reproductive problems and mastitis.
- An individual skilled in recognizing lameness is 2.5× more likely to identify an affected animal than a person who is unskilled.

## INTRODUCTION

The objective of this book is to present information in language that is easy to understand. English will not be the mother tongue of every reader and idiomatic speech varies throughout the English-speaking world. For this reason a glossary is provided.

The primary target reader is the veterinarian who practices cattle medicine and surgery. The bulk of the information falls into the category of 'need to know.' Another objective of the book is to make this type of information understandable to other individuals who work with practicing veterinarians, such as animal scientists, claw trimmers, nutritionists, and progressive producers. There are several exceptions to this need-to-know policy. Chapters 2 and 4 are dedicated to new and specialized information concerning the structure, function, and pathophysiology of the digit. This knowledge is basic to understanding certain disease processes. In other chapters, 'Technical Comments' are clearly identified as containing information that is only necessary for the benefit of students and scientists who need a deeper understanding of the scientific principles.

A feature termed 'Key Concepts' has been included in order to help the reader identify topics or ideas of greatest importance from a practical point of view. The remainder of the text explains, elaborates, or even repeats some of these concepts.

The author considers that photographs are an important component of the communication process. The captions should, for the most part, be considered as



**Figure 1-1 Cows at pasture in Costa Rica.** Cattle will lie down for up to 14 hours each day. During this period they will ruminate and produce 108–308 liters (23–68 imperial gallons or 28–81 US gallons) of saliva each day. Saliva is the natural buffer to ruminal acidosis. Encouraging dairy cows to lie down for prolonged periods is one of the keys to controlling subclinical laminitis.

part of the text, providing emphasis and reinforcement to the verbal message or idea. (See Fig. 1-1.) Many colleagues from around the world have given copies of photographs they have taken, to the author. This help is deeply appreciated. The author wishes to apologize for a poor memory regarding illustrations that credit 'anonymous' donors.

## ABOUT REFERENCES

In this book, the reader will find very few references in the text. This follows the trend in contemporary scientific books which omit references from the body of the work. Text that is congested with references is uncomfortable to read. An author can no longer accommodate the contemporary explosion of information.

A bibliography is provided with most chapters. These are included as a starting point for literature searches for use by research workers and graduate students. The majority of references have been taken from refereed journals or textbooks usually found in libraries, together with the Proceedings of the International Symposia on Disorders of the Ruminant Digit. Where an author has written multiple papers on the same subject, the most recent publication is cited.

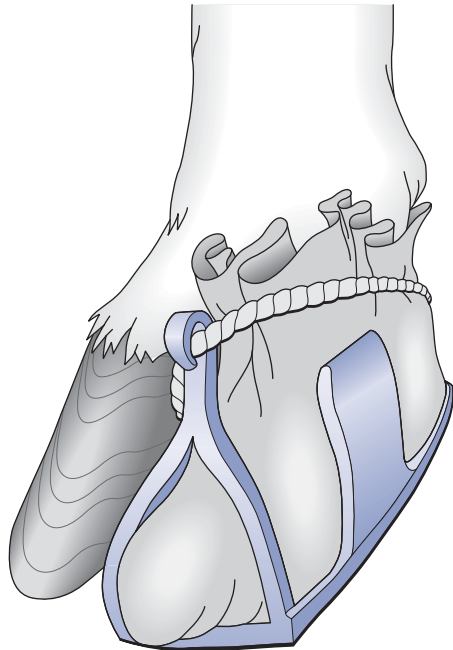
## AN HISTORICAL COMMENTARY ON LAMENESS

We tend to think of preventing lameness as a modern notion, but this is not the case. First-century Romans appear to have taken good care of their oxen:

*'Cattle will be less likely to go lame if their feet are washed in plenty of cold water when they are unyoked after work and if their hocks, the crowns of their hooves, and the division itself between the two halves of the hooves are rubbed with stale axle grease.'*

Furthermore, Roman veterinarians were among the earliest researchers to record their lameness-related activities. Once they had perfected the 'solea ferria,' a metal shoe for horses, they turned their attention to a similar device for cattle. The problem for the Romans was to increase the distance of a day's march before draft oxen became lame. To this end, they created the 'demi solea' (Fig. 1-2).

In 1534, the monk Petrus Magni produced a manual on how to run the agricultural business of a large monastery. He emphasized the importance of good bedding and cleanliness to 'protect cattle hooves from rotting.' The concern about preventing lameness in cattle is reflected in a book by Hess (1887) who also describes the destructive influence of manure and



**Figure 1-2** A demi solea is a metal shoe ingeniously fixed with cords. Topical dressings were kept in place by a cloth bag located between the claw and the shoe. The Romans did not attach shoes with nails; this came some centuries later. (Courtesy of Mosby, *Veterinary Medicine: An Illustrated History*)

moisture and points out the importance of hygiene and cleanliness. Other publications from the 19th century concerning bovine lameness are noted in the bibliography, attesting to an early interest in the problem.

Prior to 1960, there were two books of note dedicated exclusively to bovine lameness: *Malattie degli arti dei bovini* written by Professor Giuseppe Gerosa (first published in Milan in 1929) and *Klauenkrankheiten* by Hess & Wyssmann (1931). These books reflect the state of knowledge at that time, which was quite considerable. Other excellent books published in the first half of the 20th century dealt with anatomy (Wyssmann 1902), microanatomy (Mueck 1928) and the orthopedic surgery of both the horse and the cow (Pfeiffer & Williams 1900).

## THE CLINICAL IMPORTANCE OF LAMENESS

Lameness has come to be considered as the most important animal health issue next to reproductive disorders and mastitis. This evaluation is probably based

partly on the prevalence of this clinical sign and the economic importance of the causal diseases. In another sense, lameness may have even greater importance. Well-established control protocols can be implemented with respect to both mastitis and reproductive disorders; however, this is not the case with herd lameness. The increase in the incidence of lameness, particularly in dairy herds, is partly due to the fact that production technologies are being adopted without the user being aware of the implications to animal health.

## ANIMAL WELFARE

The conditions causing lameness are among the most painful diseases or disorders affecting cattle. Other painful conditions such as renal colic or displaced abomasums are not as ubiquitous as lameness. It is the sheer number of lame cows that makes bovine lameness the important welfare issue that it is. In some dairy herds, 60% of the cows can be lame in any given year; 20% of the cows can be lame at any given time in a problem herd.

It is not known how severe the pain is for the cow. Pain in the feet is shown by a cow as changes in her body language and this is used as the basis for scoring the severity of lameness (pp. 34 and 35). It is presumed that cows feel pain in their feet much as we do as there is a dense network of sensory nerve fibers and a high number of nerve endings, particularly in the sole heel bulb region.

It is known that the incidence of lameness has increased considerably in dairy herds during recent years and now has reached a point at which it is causing an unprecedented level of suffering among cattle. This thought is supported by the considerable amount of funding dedicated to lameness research. A good example is the LameCow 2002–2006 project with a budget of €30,543,890 administered by partners in the EU.

Fundamental to the issue of animal welfare is the genetic selection of dairy cows. The genetic potential for milk production in Holsteins has doubled in just over 20–30 years. Workers in some countries are alarmed that selection for production has intensified at the expense of selection for non-production traits such as 'feet and legs,' resistance to disease, and other factors that contribute to longevity and functional efficiency.

Pain (even discomfort) causes considerable stress. Pain is only the tip of the iceberg in that for every pain-producing lesion there are likely to be many other lesions in the same or other claws. However, pain may not be the only factor stressing dairy cattle. It is now believed that stressors in the environment, referred to as 'management risk factors,' increase the likelihood of lameness-causing lesions to develop in the claw. It has

been shown that these same stresses are implicated in the occurrence of other disorders, particularly those affecting fertility and perhaps mastitis.

Cow barns are designed to be convenient for farm workers rather than for the comfort of cows. Management risk factors have attracted a great deal of attention over the past 10 years, causing the subject of 'cow comfort' to emerge as a science of real concern to those seeking measures to reduce the incidence of herd lameness. For example, it is now believed that cattle can suffer psychological stress when a dominant animal interacts with a submissive animal. It is also thought that cows are stressed when they stand for long periods; inactive on hard concrete surfaces. However, correcting risk factors associated with barn design often presents insurmountable financial difficulties for dairy producers.

An important study undertaken in the UK has reported that dairy farmers who lack knowledge and skill are those who have herds with the highest incidence of lameness. Another study found that a skilled observer could identify 2.5× more animals lame than could an individual who was unskilled. The implication is that many lame animals fail to be treated. Furthermore, in Australasia, where cattle are herded along trackways, there is a noticeably higher incidence of lameness in herds where attendants are not patient and gentle with the animals.

In Sweden, the importance of animal welfare in dairy herds is already a matter of public concern. In that country, the consumer is willing to pay a premium for milk (green milk) produced on dairy farms that have been certified as meeting specified criteria for animal comfort.

Toe abscess is a condition affecting yearling beef calves and is described on pages 100–102. The cause of this condition is unknown. However, circumstantial evidence suggests that standing for long periods while being transported may be involved. Current laws in North America only require that cattle shall be unloaded every 48 hours. In order to avoid animals falling down and being trampled, they are packed tightly into trucks. Possible movement is so restricted that blood cannot move through the feet and pressure inside the claws is thought to increase, causing discomfort. Toe abscesses have been found most frequently 10 days after transportation and are so painful that calves must lie down and frequently contract pneumonia and die.

---

## ECONOMIC IMPORTANCE

The following factors have to be taken into consideration in calculating the cost of a single case of lameness in a dairy cow:

- Veterinary fees
- Cost of medication

- Value of the time of the animal attendant nursing the cow
- Loss of milk due to pain (20% of the production for the lactation can be lost if the animal becomes lame during peak lactation)
- Negative effect on reproductive efficiency
- Loss of milk if antibiotic therapy is used
- 10% of lame animals are culled prematurely; the salvage value of the culled animal will only partly compensate for the rearing costs of a heifer which will have a lower milk yield than a mature cow
- Loss of body condition
- Reduction of the economic life of a cow.

There have been numerous estimates of the cost of a single case of lameness. One lame cow will cost the producer at least US\$350. Estimates for losses experienced in large high-production herds run into many thousands of US dollars annually.

---

## EFFECT OF LAMENESS ON REPRODUCTIVE EFFICIENCY

When a cow becomes lame, she loses her status of dominance among the rest of the herd. She becomes less competitive for resources such as water, forages, and concentrates. Lameness also causes the interval between calving and conception to increase. One of the reasons for this is that the associated pain reduces the ability of a lame cow to ride another during oestrus. This in turn will reduce the cowman's ability to detect heat.

The cow is likely to spend more time lying down and, in so doing, becomes more liable to injury by other cows and/or to suffer from bed sores. When lame, a cow spends more time lying during a single lying event, but less total time lying in a day. A cow will also stand longer in a free stall before attempting to lie down and will change positions much less often while lying down.

In one study it was reported that lame cows had a lower conception rate at first service (17.5% versus 42.6%) and a higher incidence of ovarian cysts (25.0% versus 11.1%) than controls. Cows becoming lame within the first 30 days postpartum are associated with a higher incidence of ovarian cysts, a lower likelihood of pregnancy, and lower fertility than control cows.

One further sequel of stress may be the slower involution of the uterus after parturition.

Bacterial endotoxins originating from the break down of bacterial walls (e.g., caused by ruminal acidosis) have a negative effect on ovarian function. Endotoxins also have a number of direct and indirect local effects in the organ systems, including the claw.

### TECHNICAL COMMENTS

As stress from pain caused by lameness increases, it is believed that the secretion of adrenocorticotrophic hormone (ACTH) will also increase with an associated reduction in the liberation of luteinizing hormone (LH). These physiological changes will result in significant alterations in the manifestations of heat, and have shown to result in reduced, aberrant, or asynchronous LH release and abnormalities in ovulation.

A fundamental role in the pathogenesis of fertility disturbances is played by the negative energy balance (NEB) which is invariably experienced by the lame cow. Studies have shown that this causes a reduction of the secretion of gonadotrophin releasing hormone (GnRH) and LH which are essential for starting and maintaining cyclic ovarian activity. Progesterone secretion during the luteal phase is also strongly reduced in cows experiencing NEB. Prompt treatment and recovery are essential to reduce the duration of NEB combined with stress.

As a consequence of these hormonal disturbances, there is a high probability of pregnancy failure, anestrus, and, under severe prolonged stress, atrophy of the ovaries. Herds with the highest incidence of lameness are usually those having the highest production and are the most intensively managed.

### RECORDING FOOT LESIONS

A record of the incidence and prevalence of lesions in the feet of cattle is essential in order to determine the risk factors likely to be involved in herd lameness problems. This is a very important task for claw trimmers who should be recording all lesions they encounter during trimming sessions. Some lesions to be recorded may not have developed to the stage where they are causing lameness or which are being resolved by appropriate trimming methods. Further information should be contributed by the veterinarian, much of which will speak to the severity and treatment of the lesion. Dairymen must record all cases of lameness, particularly those caused by infectious diseases treated by farm staff. These various inputs give a comprehensive picture of the herd lameness problem.

There are electronic data recording systems available now which have been developed by or in collaboration with hoof trimmers. Such an electronic system was

developed by the National German Agriculture Society (DFG). The 'LameCow' system is available in different languages including English. Electronic recording is future oriented and has many advantages for cow-side data-recording. For the time being claw trimmers prefer to write their findings on a record sheet.

### LAMENESS IN DIFFERENT PRODUCTION SYSTEMS

Lameness is directly related to and influenced by the system of cattle management.

#### Intensive Dairy Production

The greatest increase in the incidence of lameness has taken place in high-production intensively managed dairy herds. Problems have resulted from greater confinement and increasing herd size. Many cows spend their entire lives walking on concrete. Restricted freedom of movement results from poor barn design. There is an increasing tendency, as herd size increases, for feedstuffs to be purchased from different sources. This results in the quality of the feedstuffs being inconsistent and contributing to poor nutritional management.

There has been a remarkable increase in the prevalence of digital dermatitis since the disease was first reported in 1974 (pp. 207–211). There has also been an increased incidence of subclinical laminitis (pp. 40–49) and the disorders that complicate this condition.

#### Pasture Managed Dairy Production (see Chapter 8)

In New Zealand and South West Australia, dairy cows are maintained on pasture. The predominant cause of lameness is trauma occurring when cattle are herded from the pasture to the milking station. Until recent years, dairy cows have received no concentrate supplementation. Under these circumstances, milk production was much lower than in intensively managed herds but the incidence of lameness was quite low. Today lameness is on the increase in herds in which concentrate supplements are given.

In various countries in South America, extensive management of dairy cows is practiced, but supplementation of the ration with concentrates is common. Silage is also fed during the winter months. Under these conditions, the incidence of lameness is much higher than it is in Australasia.

In temperate climates, some herds graze pastures only during the summer months. The transition periods during which cows go to grass for the first time and in the fall when they are housed full time are periods when problems can be observed.

### Cow-Calf Beef Herds

Herds of beef cattle usually are maintained on pasture year round. Problems can arise if the quality of the winter diet is significantly inferior to that during the spring and summer.

On the Canadian prairies the incidence of vertical fissures is, on average, 17% of adult beef cattle, with the incidence in some herds reaching 60%. The same condition has been reported in southern Sweden. The cause of this problem may be related to sudden changes in the quality of the diet due to seasonal variations in climate.

### Feedlot Cattle

The main problem in fattening steers is laminitis brought on by the practice of feeding rations compounded with a concentrate-to-forage ratio in excess of 80:20. Lack of exercise and sudden changes in the components probably exacerbate this problem. In certain parts of North America there is a high prevalence of toe abscesses in yearling steers which may be due to the stresses of transportation. This condition is causing considerable economic losses. In feedlots the incidence of traumatic injuries is usually much higher than it is in other cattle populations.

In Italy, young steers (not castrated) are often kept on slatted floors. They experience acute laminitis – mostly precipitated by traumatic injuries during mounting activities. Overgrowth of the claws is also common on slatted floors with consequent lesions in the apical white line frequently complicated by abscessation.

### BIBLIOGRAPHY

Äkerblom E 1934 Über die Ätiologie und Pathogenese der Futterrehe beim Pferds. Dissertation, Stockholm  
Anker M 1854 Die Fusskrankheiten der Pferd und des Rindviehes. Bern und Zürich  
Bargai U, Levin D 1993 Lameness in the Israeli dairy herd – A national survey of incidence, types, distribution and estimated cost (first report). *Israeli Journal of Veterinary Medicine* 48:88–91

Barkema H W, Westrik J D, Keulen Van K A S et al 1994 The effects of lameness on reproductive performance, milk production and culling in Dutch dairy farms. *Preventive Veterinary Medicine* 20:249–259  
Baumgartner C, Distl O 1990 Genetic and phenotypic relationships of claw disorders and claw measurements in first lactating German Simmental cows with stayability, milk production and fertility traits. *Proceedings of VI International Symposium on Disorders of the Ruminant Digit*, Liverpool, UK p 199  
Bonsma J C 1973 In: Cunha T J, Warwick A C, Koger M (eds) *Factors affecting the calf crop*. University of Florida Press, Miami  
Capuco A V, Smith J J, Waldo D R et al 1995 Influence of prepubertal dietary regimen on mammary growth of Holstein heifers. *Journal of Dairy Science* 78:2709–2725  
Collick D W, Ward W R, Dobson H 1989 Associations between types of lameness and fertility. *The Veterinary Record* 125:103–106  
De Stefanis 1854 Metodo curativo della gangrenoso falangeo della vacche, ditto zoppina. *Il Veterinario* p 201  
Eletti S 1841 Dell'ulcera fistoloso gangrenosa falangea della vacca, detta zoppina  
Esselmont R J, Spincer I 1993 The incidence and costs of diseases in dairy herds DAISY Report 2. Department of Agriculture, University of Reading  
Gerosa G 1929 *Malattie Degli Arti Dei Bovini*. Istituto Editoriale Cisalpino, Milano  
Gill G S, Allaire F R 1976 Relationship of age at first calving, days open, days dry and herd life to a profit function for dairy cattle. *Journal of Dairy Science* 59:1131–1139  
Goldberg S A 1922 The lesions of necrobacillosis. *Cornell Veterinarian* 12:272–274  
Greenough P R 1962 Observations on some of the diseases of the bovine foot. Part I & II. *Veterinary Record* 74: 53–63  
Harms 1885 Das Panariticum beim Rinde. *Bollinger und Frank's Zeitschrift* p 135  
Hess E 1887 Die Fußkrankheiten des Rindes und die Anwendung der Zwangsmittel. Verlag Drell, Füllli & Cie, Zürich p 8–9  
Hess 1913 Die Klauenkrankheiten des Rindes Handbuch der Tierärztlichen Chirurgie und Geburtshilfe. 3<sup>a</sup> Parte  
Hess E, Wyssmann E 1931 *Klauenkrankheiten* Verlag. Urban und Schwarzenberg, Berlin und Wien, p 32–33  
Lafore 1843 *Traitédes maladies particulières aux grand ruminants*, Toulouse  
Lee L A, Ferguson J D, Galligan D T 1989 Effect of disease on days open assessed by survival analysis. *Journal of Dairy Science* 72:1020–1026  
Maclean C W 1965 Observations on acute laminitis of cattle in south Hampshire. *Veterinary Record* 77:662–672  
Mazzini 1884 Sulla podoparenchidermite acuta delle vacche. *Volgarmente detta zoppina*, Lombarda  
Melendez P, Bartolome J, Archbald L F et al 2002 The association between lameness, ovarian cysts and fertility in dairy cows. *Theriogenology* 59:927–937  
Mortensen K, Hesselholt M 1982 Laminitis in Danish dairy cattle – an epidemiological approach. *Proceedings of the*

- IV International Symposium on Disorders of Ruminant Digit, Paris
- Moser E, Westhues M 1950 Leitfaden de Huf- und Klauenkrankheiten, 2, Auflage. Ferdinand Enke Verlag, Stuttgart
- Mueck, J 1928 Histologische Untersuchungen über den Aufbau der Weißen Linie an den Klauen von Rind, Schaf, Ziege und Schwein. Wien, Univ Veterinärmed. Fak., Diss
- Nilsson S A 1963 Clinical, morphological and experimental studies of laminitis in cattle. Acta. Veterinaria Scandinavia 4(Suppl 1)
- Noble, K M, Trebble J E, Harvey D et al 2000 Ultrasonography and hormone profiles of persistent ovarian follicle (cysts) induced with low doses of progesterone in cattle. Journal of Reproduction and Fertility 120:361–366
- Pfeiffer W, Williams W L 1900 A course in surgical operations for veterinary students and practitioners. Bailliere, London
- Rusterholtz A 1920 Das spezifisch-traumatische Klauensohlengeschwür des Rindes. Schweiz Archiv Fur Tierheilkunde 62:421
- Schleier H 1953 Klauenpflege Beim Rind. S Hirzel Verlagsbuchhandlung, Leipzig
- Solleysel 1691 Le parfait maréchal. Cited by Åkerblom, 1934
- Stockfleth H V 1863 Cliniske Jagtagelser 11 p 165
- Toussaint-Raven E 1973 Determination of weight-bearing by the bovine foot. Netherland Journal of Veterinary Science 5:99–103
- Wyssmann E 1902 Anatomie der Klauenlederhaut. Bern Universitat Veterinärmed. Fak. Diss

# Microstructure and Function of the Bovine Claw

## GENERAL INTRODUCTION

### GLOSSARY

**Foot:** Strictly speaking, the word foot describes the region from the hock to the apex of the claw. In this book the word 'foot' will describe the digital region distal to the fetlock.

**Claw:** The word 'claw' is used to define the organ at the end of the digit of cattle, i.e. capsule and contents. The same structure in the horse is referred to as the 'hoof.' The claw comprises the hard cornified claw capsule plus all the structures enclosed by the capsule – bones, joints, ligaments, tendons, fat, cushions, connective tissue, blood vessels, and nerves.

**Claw Capsule (*Capsula Ungulae*):** The capsule is the shoe-like structure composed of horn into which the pedal bone and surrounding soft tissue fit. It is sometimes referred to as the 'shoe.'

**Proliferation:** The production of new epidermal cells by division of living cells in the basement layer (mitosis).

**Keratinization or Differentiation:**

The unidirectional development of epidermal cells (produced in the basal layer) to cornified horn cells. It is characterized by synthesis of keratins and intercellular cementing substance: it is terminated by transformation of the living epidermis in claw horn, i.e. cornification (cell death).

**Cornification:** The final stage of epidermal differentiation at which a solid/stable horn cell has been formed and which is connected to neighboring cells.

**Desmosomes (*Macula Adherens*):** Desmosomes are cell contacts establishing a mechanical stable cell-to-cell contact. Each desmosome consists of two halves. Each half belongs to one of two neighboring cells. Each half desmosome has intracellular and extracellular components.



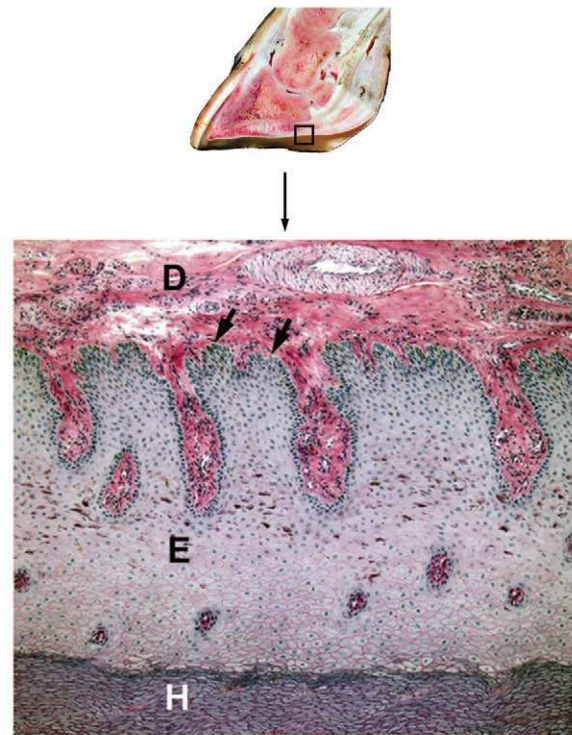
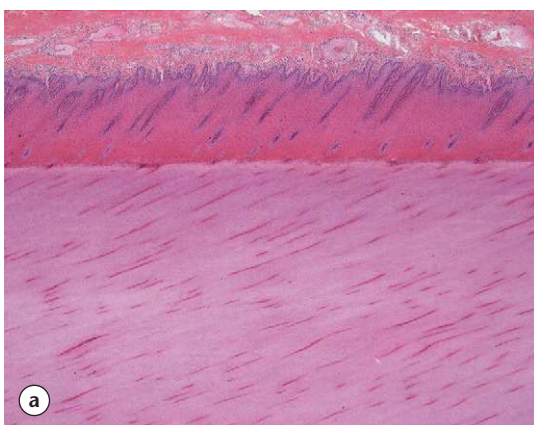
Trying to remember long Latin names is at best difficult and at worst boring. Furthermore, anatomical terminology can be confusing. Nevertheless, knowledge of anatomy is essential if some of the complex problems involved in lameness are to be understood. Sometimes several terms refer to the same structure. In this chapter the terminology will be based on the simplest descriptors that are most widely used in the field today.

## THE EPIDERMIS

The pedal bone and related structures are completely covered with modified skin. This modified skin, as it does in skin elsewhere in the body, consists of three layers – subcutis, dermis, and the superficial epidermis. The epidermal capsule is composed of inner living cells and a thick layer of dead, cornified cells, the claw horn. This capsule is referred to as the claw capsule, which is a slipper-shaped structure. For convenience, anatomists have broken down the claw capsule, and the underlying dermis and subcutis, into five component segments. These are the coronary band (periople segment), the wall (the coronary segment), the epidermal lamellae (wall segment), the solear segment, and the bulbar segment. Please note that in the preceding sentence the correct anatomical term is placed in parentheses following the term that is in current usage. The microstructure of each segment has unique characteristics. However, all of the segments have a ‘living epidermis’ separated from the dermis by a basement membrane. It is at this level many pathological processes are initiated.

Beneath the dermis is the subcutis, in some segments modified into cushions.

See Figures 2-1–2-3.



**Figure 2-1** A section of the sole showing: (D) The dermis with dermal papillae which represent the tubules in the sole. (E) The epidermis. The arrows indicate the dark staining ‘mitotic’ cells of the ‘living’ epidermis. The lighter stained cells of the remainder of the living epidermis demonstrate the progressive loss of their nuclei from top to bottom of the picture. (H) This darker layer represents the fully keratinized cells of the outer layer of the sole. (Courtesy of C K W Mülling)

**Figure 2-2** These pictures show the cellular structure of the claw wall. (a) The top layer is the vascular dermis, the middle layer is the living epidermis and the lower half represents the keratinized horn of the sole. (b) This is a cross-section of the keratinized wall showing the distribution of tubules each plugged with medullary debris (incomplete, cornified horn cells). (c) The scanning electron micrograph shows the proximal opening of a tubule. The papillary pegs of coronary dermis fit into these openings. (Courtesy of C K W Mülling)

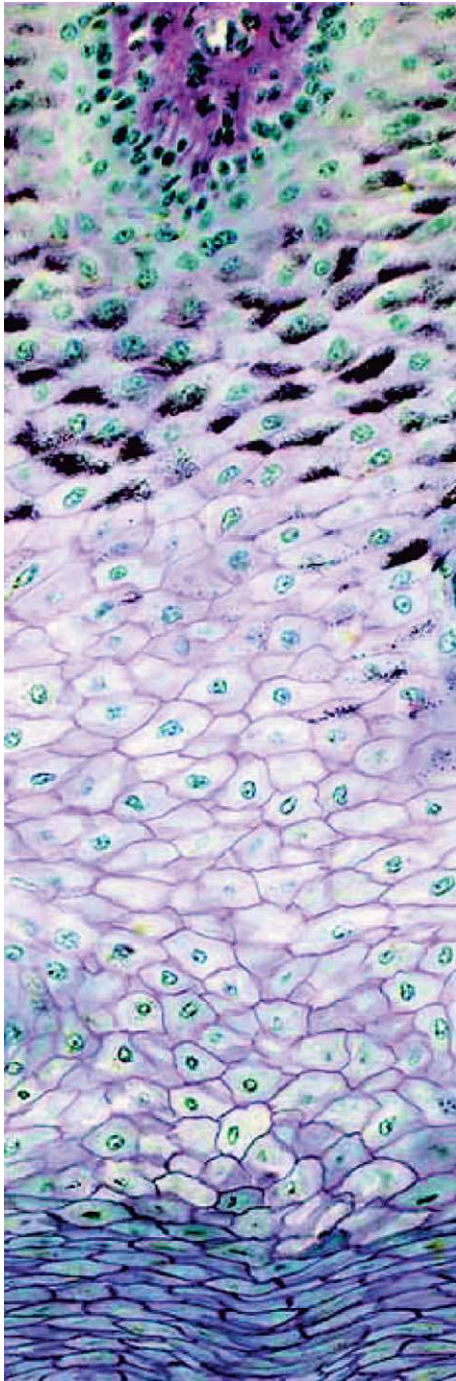


Figure 2-3 This picture shows the transition across the living epidermis from the intensely stained mitotic cells approximating the dermis at the top of the picture to the flattened keratinized, dark staining cells that have lost their nuclei at the bottom. (Courtesy of C K W Mülling)

## THE LIVING EPIDERMIS

### TECHNICAL COMMENTS

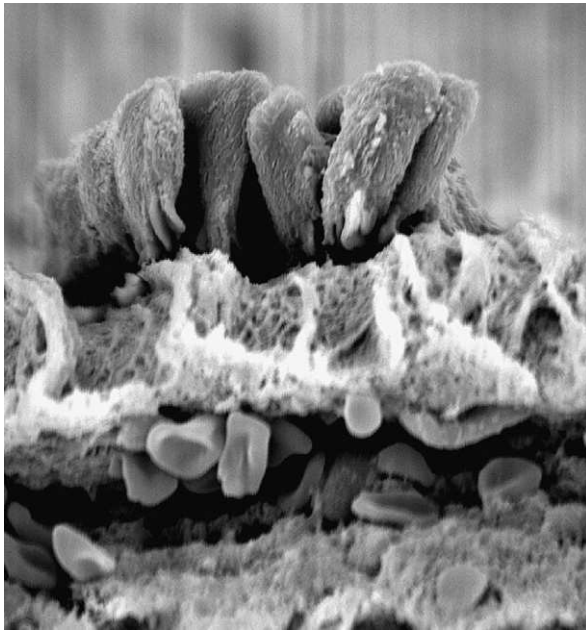
The epidermal cells are connected permanently to the basal layer on one side and extend out to the surface of the wall on the other. This intercellular connection is made by desmosomes and intercellular cementum. The latter is the major connection between the horn cells.

Inside each epidermal cell there are electron-dense plaques. Connected to these two plaques are keratin filaments (tonofibrils) which form the 'cytoskeleton.' The cytoskeleton is connected to the desmosome.

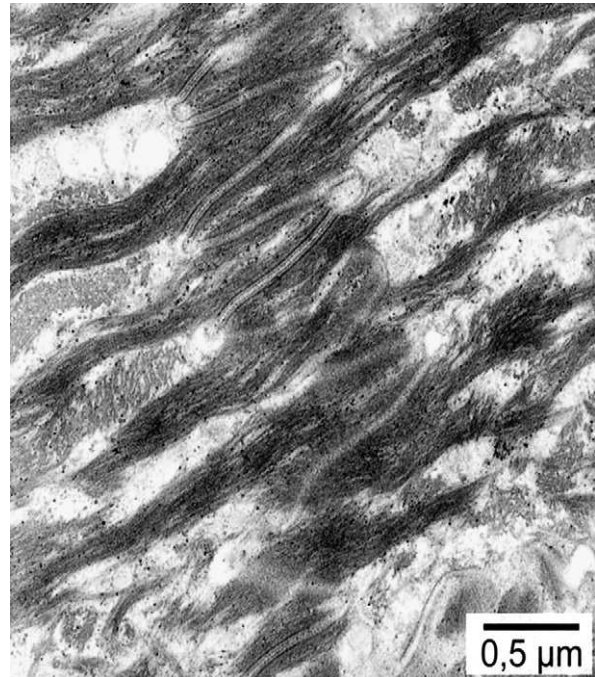
In the space between the cells, specific desmosomal glycoproteins establish cell-to-cell adhesion. It is important to understand that the tonofibrils do not cross between cells.

The basement membrane (BM) consists of three layers. The *lamina densa* forms an electron-dense midline, on the outside of which is the *lamina rara* which makes a foundation for the mitotic cells of the living epidermis. Both of these layers are produced by the living epidermal cells. The innermost layer of the basement membrane is the *lamina fibroreticularis* which, as its name implies, consists of anchoring collagen fibers which connect the basement membrane to the network of collagen fibers in the dermis. This layer is produced by dermal fibroblasts and is the part of the basement membrane that is susceptible to degradation by matrix metalloproteinases (MMPs).

The living epidermis sits on the basement membrane (Fig. 2-4) and it also has different layers of cells. The first is the *stratum basale*, with cells dividing mitotically. The next layer is the *stratum spinosum*, in the cytoplasm of which keratin filaments can be observed radiating from the desmosomes (intercellular adhesions, Fig. 2-5). The keratin filaments form an internal three-dimensional cytoskeleton which establishes the mechanical strength of the epidermal cell while retaining flexibility. The third layer, the *stratum granulosum*, exists only in the regions where soft horn



**Figure 2-4** Scanning electron micrograph (SEM) showing a group of basal epidermal cells on the surface of a dermal lamina. The basal cells have long basal processes reaching into the dermis. In the dermis under the basal cells a capillary is opened containing red blood cells. The dermal tissue between basal cells and the vessel wall is the tissue that oxygen and nutrients have to travel through on their way to supply the avascular epidermis. (Courtesy of C K W Mülling)



**Figure 2-5** Desmosomes (arrows) connecting two neighboring epidermal cells in the stratum spinosum. Bundles of tonofilaments connect the cytoskeleton to the intracellular plaques of the hemidesmosomes. (Courtesy of C K W Mülling)

is produced, i.e., the bulb and periople. The living epidermis is nourished via diffusion from the microvasculature of the dermis.

The basement membrane is frequently referred to as the dermo-epidermal junction. It is of particular importance in regulating the proliferation and differentiation of the mitotic cells of the living epidermis. The regulatory cascade leading to increased basal proliferation is activated by a variety of mechanical and biochemical stimuli including growth factors and cytokines. Growth factors, including epidermal growth factor (EGF), migrate through the basement membrane to bind at their specific receptors in the basement layer (*stratum basale*). The signaling between dermis and epidermis is sometimes referred to as 'cross-talk.'

The collagen of the innermost layer of the basement membrane (*lamina fibroreticularis*) is a substrate

for activated MMPs which are enzymes designed to degrade collagen – the major component of connective tissue. The MMPs play an important role in the normal turnover of connective tissue. An increase in the activated form of MMPs is also believed to be responsible for pathological alterations in some forms of laminitis.

Vasoactive substances and endotoxins originating in the rumen as the result of acidosis, metabolic disorders, or inflammatory processes, and/or hormones either interfere directly with the microcirculation in the claw or trigger the release of cytokines, which in turn affect the tissue integrity in the claw. The result is a disturbance in or even disruption of horn production for short or long periods and with varying degrees of severity.

The forgoing suggests that two distinctly different pathophysiological events are possible. Collagen degra-

ation and horn disruption may occur singly or in concert.

Pressure on the sole of the claw is transferred via the epidermis to the basal cell layer, stimulating proliferation of cells and thereby accelerating the production of horn. Functional claw trimming aims to distribute load evenly between both claws. The objective of trimming is to avoid pressure overload of one sole leading to increased horn production and enlargement of a region of the sole, usually the heel (overburdening). Functional claw trimming interrupts the vicious circle which occurs in mechanical overload of the claw. On the other hand thinning of the sole in routine claw trimming also increases pressure on the keratogenic cells, stimulating the production of healthy horn.

In the wall the mechanical stimulus for increased proliferation and subsequent horn production is created by direct tensile force rather than pressure.

See Figures 2-6–2-8.

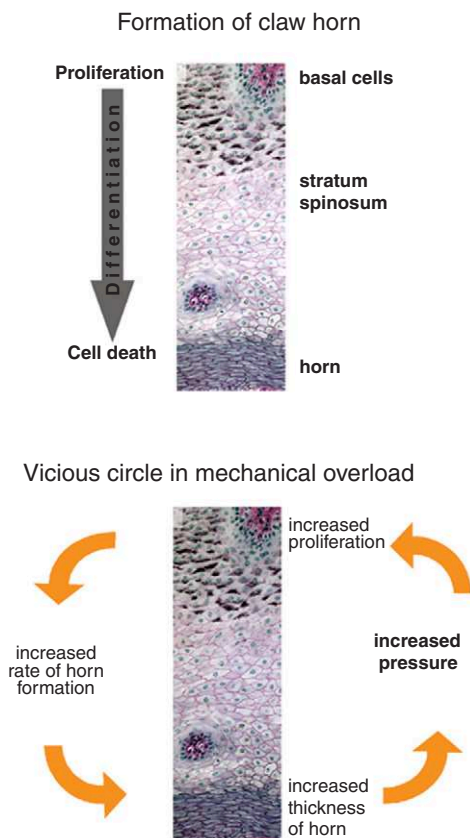


Figure 2-6 Composite illustration of growth and vicious circle in mechanical overload. (Courtesy of C K W Mülling)

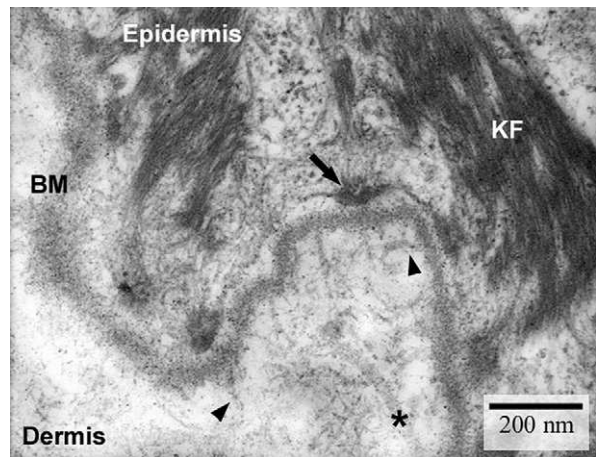


Figure 2-7 An electron micrograph (EM) of the dermo-epidermal junction. The basement membrane (BM) is located between the basal processes of a basal epidermal cell and the underlying dermis. Keratin filaments (KF) stabilize the epidermal cell. They are anchored to hemidesmosomes in the cell membrane (arrow). Outside the cell membrane follows the electron-lucent 'lamina rara' and then the dense 'lamina densa'. These two are product of the epidermis. The connection to the dermal collagen system (asterisk indicates a collagen fiber) is established by anchoring fibers of the lamina fibroreticularis (arrowheads) which is a product of the dermal fibroblasts. (Courtesy of C K W Mülling)

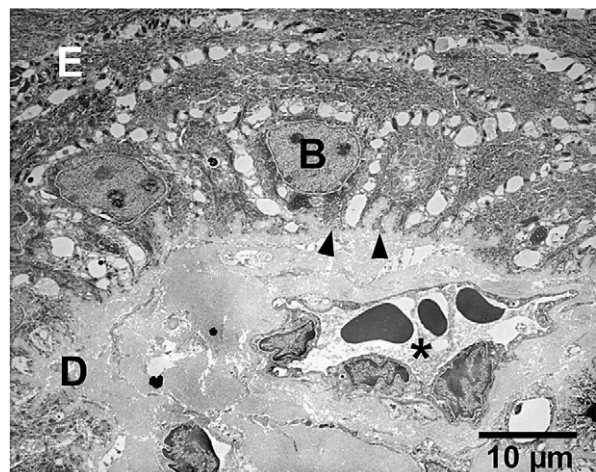
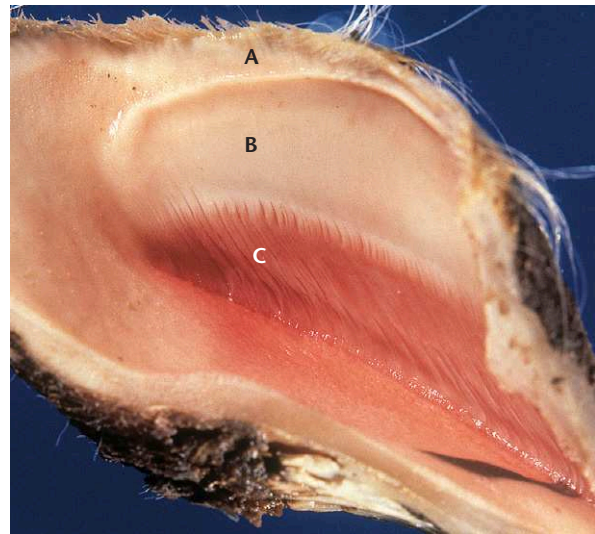


Figure 2-8 Low power EM of the dermo-epidermal junction. (E) Epidermis, (B) Basal cell. Arrows indicate the position of the basement membrane. (D) Dermis. Asterisk indicates a dermal capillary containing three red blood cells, which is in close proximity (1–2μm) to the basement membrane. The distance between the capillary and the basal epidermal cell would be the diffusion distance for supply with oxygen and nutrients. (Courtesy of C K W Mülling)

## THE SEGMENTS OF THE CLAW CAPSULE

### KEY CONCEPTS

- Claw segments are five different regions of the capsule together with the underlying associated dermis and subcutis. Therefore, each segment has a specific configuration of a dermal papillary body, specific modes of cornification, and specific architecture of claw horn. The claw can be divided into five segments: periople, coronary segment, wall, sole, and bulb.
- The dermal papillae interfacing with the proximal ends of tubules are conical in shape while those of the dermal lamellae form folds to correspond with the leaflets of the epidermal lamellae.



**Figure 2-9** The inside of the claw capsule showing the following features: (A) Groove for dermis of the periople from which the coronary band originates. (B) Depression for the dermis of the wall (coronary epidermis) together with the coronary cushion. (C) The dermal lamellae, which are longer on the dorsal wall and significantly shorter towards the abaxial groove. Note that there are no epidermal lamellae on the inner surface of the bulb.

### Coronary Band, Limbus or Periople (the Periople Segment)

The coronary band is a thin strip of soft tubular horn about 1.5cm wide forming the region or segment between exposed wall and the skin of the pastern. It is the equivalent of the human cuticle.

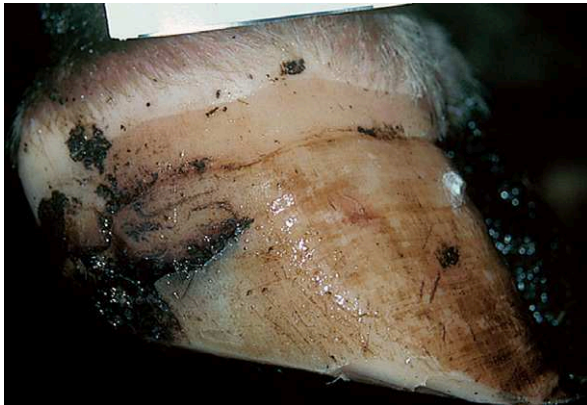
The coronary band of some cattle is unusually rough, wrinkled, and perhaps darker in colour than normal. The significance of this type of appearance is unknown. If numerous animals in a herd are showing this abnormality, the possibility of nutritional and/or micronutrient deficiency should be investigated. The coronary band is rich in lipids, therefore, lipid metabolism may be disturbed.

The coronary band is produced by cells lining a narrow groove at the hair line referred to as the periopic dermis which merges with the soft resilient horn of the bulb of the heel. The continuity of the coronary band with the bulb of the heel can be readily seen in the fetus.

See Figures 2-9–2-11.



**Figure 2-10** The abaxial groove marks the transition between the wall and the heel bulb. On the interior surface of the claw the epidermal/dermal lamellae come to an end a few centimeters anterior to this point; see also Fig. 2-9.



**Figure 2-11** The coronary band is the smooth band of horn adjacent to the hair line. It covers the coronary cushion and protects the living epidermis of the wall (coronary epidermis) which lies beneath.

### Wall (Coronary Segment)

#### TECHNICAL COMMENTS

In anatomical terminology the word wall is applied to the epidermal and dermal lamellae which are located beneath the cornified coronary epidermis.

The terms *strata externum*, *medium*, and *internum* identify different layers of horn making up the thickness of the wall (coronary horn). These different layers should not be confused with segments.

The average length of the dorsal surface of the claw of an adult female should be 7.5cm. For practical purposes the wall grows at the rate of 0.5cm per month. This rate may increase during summer months, in young animals and in animals maintained on a high plane of nutrition. Measuring the distance from the hair line to a horizontal (hardship) groove or other defect allows a clinician to calculate when the insult to the animal causing the defect occurred.

The wall (coronary epidermis) is composed of horn, in which epidermal tubules run lengthwise parallel to the surface of the claw. Proximally the dermal papillae fit into the proximal ends of the epidermal tubules.

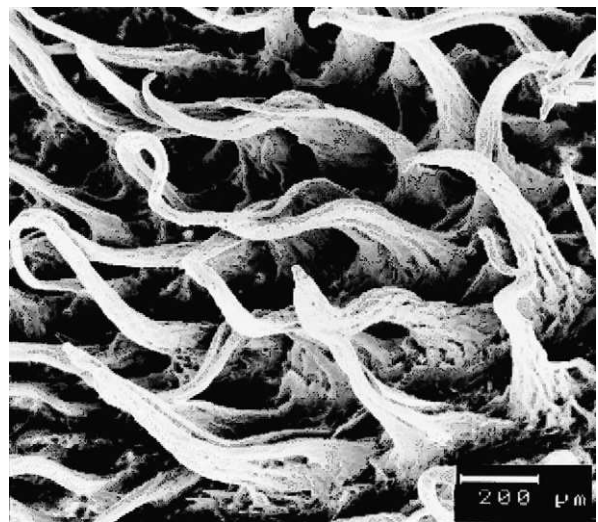
There are more tubules per mm<sup>2</sup> closer to the outer surface of the wall than there are close to the dermis. Some workers believe that the higher the density of the tubules the greater will be the biomechanical stability of the wall by directing mechanical stresses to that region.

Therefore, tubule density graduation across the wall could be a mechanism for smooth energy transfer. Tubule density acts in concert with changes in stiffness that result from changing levels of moisture content. The moisture content of the wall is generally considered to be about 26%. When the moisture content falls, as is the case during dry environmental conditions, the wall becomes brittle.

The wall (coronary epidermis) is produced by the epidermis covering the coronary dermal papillae which are concealed beneath the coronary band. As the wall grows it is pushed towards the tip of the toe and makes up the most visible part of the capsule structure. The microcirculation to the dermal papillae can be compromised by mechanical blockages (thrombi) which will reduce the rate of blood perfusion. Reduced blood flow or complete disruption of the microcirculation may alter the differentiation and cornification of epidermal cells, i.e. the production of horn. The horn of reduced quality produced under these circumstances is called dyskeratotic horn; it is of inferior quality and reduced biomechanical stability. In addition to qualitative changes the rate of horn growth may diminish and/or the rate of horn growth may become irregular causing the appearance of striations (rugae).

The wall is produced only by the keratogenic cells lying under the coronary band. The wall and coronary band are two structures independent of each other.

See Figure 2-12.



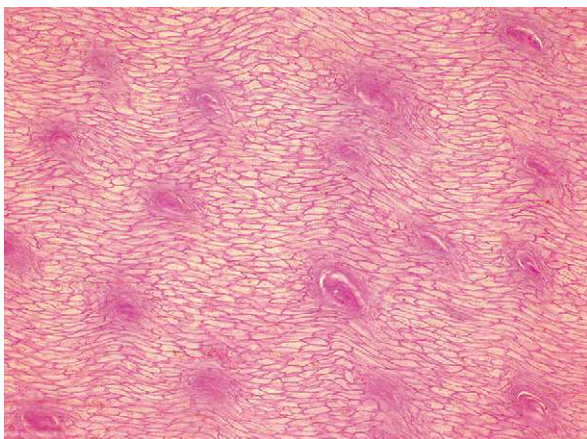
**Figure 2-12** The living epithelium covers the dermal papillae. The peripapillary (around the papillae) and suprapapillary (above the papillae) living epidermis produce horn in a tubular arrangement corresponding to the papillae which fit into the proximal ends of the epidermal tubules. (Courtesy of C K W Mülling)

### TECHNICAL COMMENTS

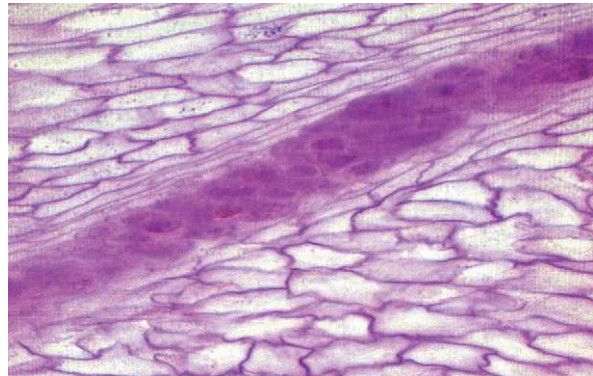
A horn tubule consists of a central part, the 'medulla,' which is composed of soft and brittle horn. The outer part, 'the cortex,' is constructed of stable horn cells. In the cortex each layer of keratinized cells is arranged, like the layers of an onion, in a spiral fashion giving strength and flexibility to the structure. The horn quality and resistance against destructive environmental influences depends on the dimensions of the medulla/ cortex ratio and the number of horn tubules.

Recent studies have revealed that the diameter of horn tubules is influenced significantly by the hardness of the flooring. Hard floors lead to increased thickness of and a higher proportion of medullary horn in the tubules with the consequent loss in horn quality (i.e., increased wearability and increased vulnerability to mechanical, chemical, and bacterial destruction). Therefore, the tubules are points of vulnerability in the claw horn. Close to the ground surface the central part, the medulla, becomes brittle and falls out, so that patent tubule develops. These tubules provide entrance for contamination and bacteria, permitting an ascending horn destruction process to take place.

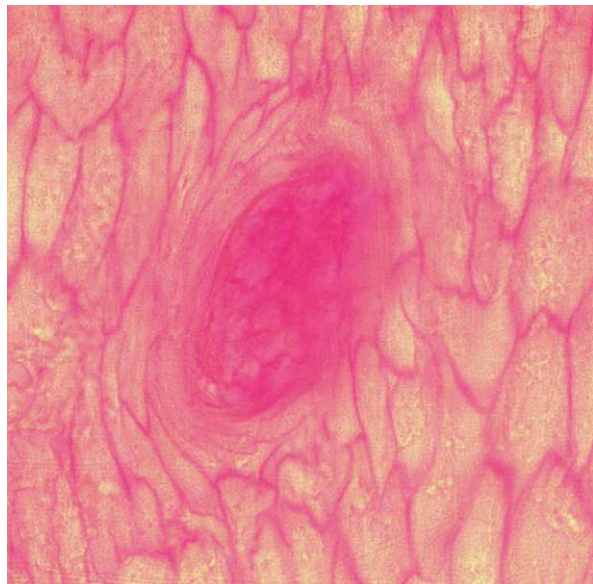
See Figures 2-13–2-15.



**Figure 2-13** These are transverse sections of tubules showing the walls of some are thicker than others. The tubules are larger in diameter closer to dermis. (Courtesy of C K W Mülling)



**Figure 2-14** Tubules in the wall originate in the epidermis of the coronary band and run distally parallel to the dorsal surface. The lumen of a tube (medulla) is clogged with debris (incomplete, cornified, disintegrated horn cells). (Courtesy of C K W Mülling)



**Figure 2-15** The cross-section of an individual tubule. There are onion-like layers of keratinized cells, wrapped spiral-fashion around the medulla. (Courtesy of C K W Mülling)

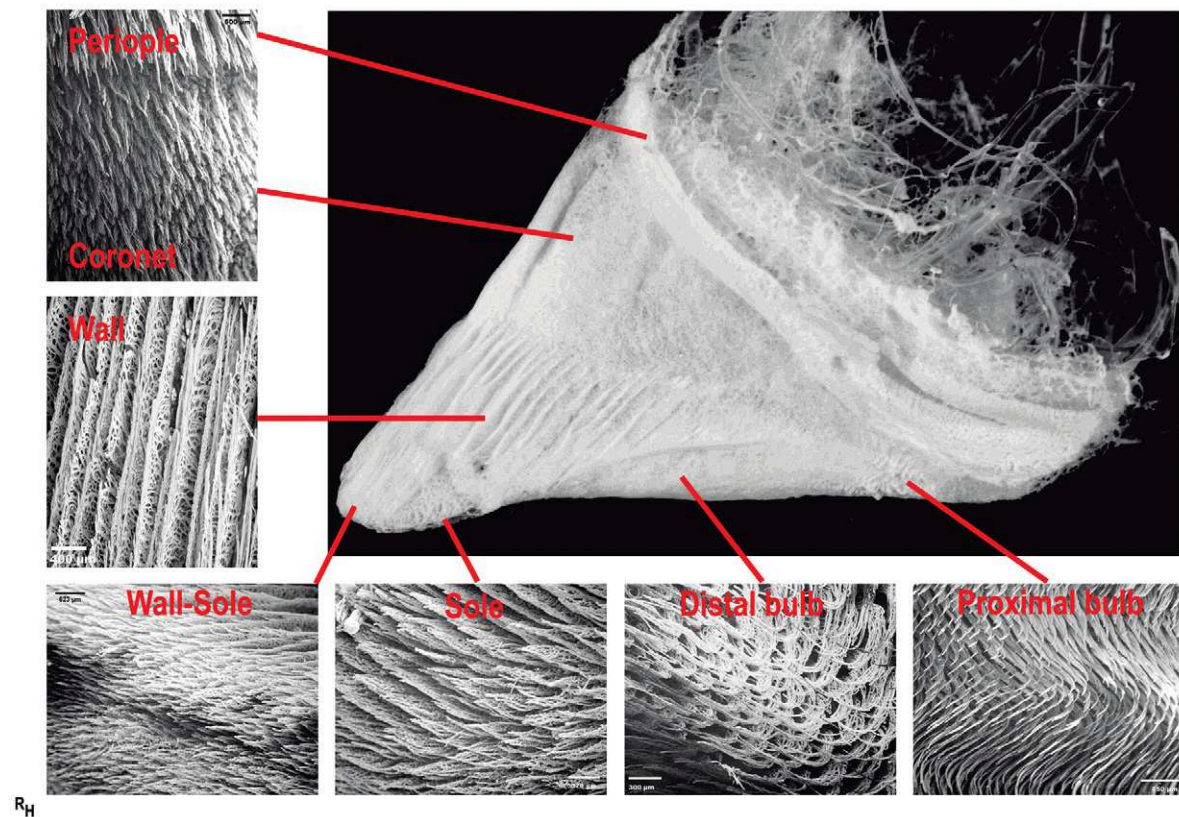


Figure 2-16 An electron micrograph showing the variations in the appearance of dermis in different segments of the digit. (Courtesy of R M Hirschberg)

### Lamellae (Wall Segment)

**GLOSSARY**

**Lamellae:** These are leaflets of horn lining the inside of the wall (coronary epidermis). The term lamellae or epidermal lamellae will be used in this text.

**Laminae:** These are leaflets of connective tissue, collagen fibers blood vessels, and nerves that fit exactly between the lamellae. The term laminae will be used interchangeably in this text with the correct anatomical term 'dermal lamellae.'

**KEY CONCEPT**

- The laminae and lamellae are structures corresponding perfectly in shape that are formed by two different tissues, dermis and epidermis, separated by a basement membrane.

**TECHNICAL COMMENTS**

For anatomists the wall segment is made up of the interdigitating dermal laminae and epidermal lamellae in the wall region covered by coronary horn (Fig. 2-16). At the ground surface of the claw this segment emerges as the 'white line'. Therefore, the white line is situated between coronary horn and sole horn. The lamina (dermal lamella) has two layers, the superficial *stratum papillare* or *lamellatum* and the deep *stratum reticulare*. Both strata contain the dermal system of blood vessels and nerves.

In summary, the dermal lamellae on one side of the basement membrane contain the vascular system and on the other epidermal lamellae is composed of living and keratinized cells. Dermal and epidermal lamellae interdigitate consisting of two different types of tissue but having the same mirror-image shape.



The disease laminitis was first described in horses as an acute inflammation of the dermal laminae. It is doubtful if inflammatory processes occur in the developmental stages of bovine laminitis. In cattle, regions of the dermis other than the laminae are affected and for this reason the internationally accepted term '*pododermatitis asceptica diffusa*' was introduced as a more accurate descriptor.

It is assumed that, as in the horse, desmosomes in the living epidermis break and reform continuously to enable the epidermis to slip past as the wall grows. Each cell has hundreds of these 'temporary' contacts in the living layer. They are continuously broken down and replaced, therefore, there are always a sufficient number of cells with stable connections to their neighbors, even when some cells lose their contacts and slide distad. This slide-contact mechanism allows the load to be supported even during claw growth.

Laminae increase the surface area to which the suspensory apparatus of the digit is attached (p. 20). This serves two purposes: better nutritional supply via diffusion and good mechanical connection and stability of the dermo-epidermal connection.

In the proximal half of the lamellar region there is almost no horn production. Notwithstanding, horn repair will occur in any part of the wall following trauma or surgical interference involving the wall and lamellae. However, scar horn formation usually lacks the leaflets and the new horn produced will tend to have an irregular shape.

In the distal half of the lamellar region the rate of proliferation of basal cells in the living epidermis increases, as does the consequent production of horn the closer it approaches the sole. The lamellar horn produced in the lamellar region reaches the ground surface of the claw as the 'white line.'

See Figures 2-17–2-19.

### The Sole (Solear Segment)

#### GLOSSARY

**Solear:** This is the adjective preferred to describe zones 1–5.



Figure 2-17 The appearance of the normal laminae (dermal lamellae) of an exungulated claw. (Courtesy of P Ossent)

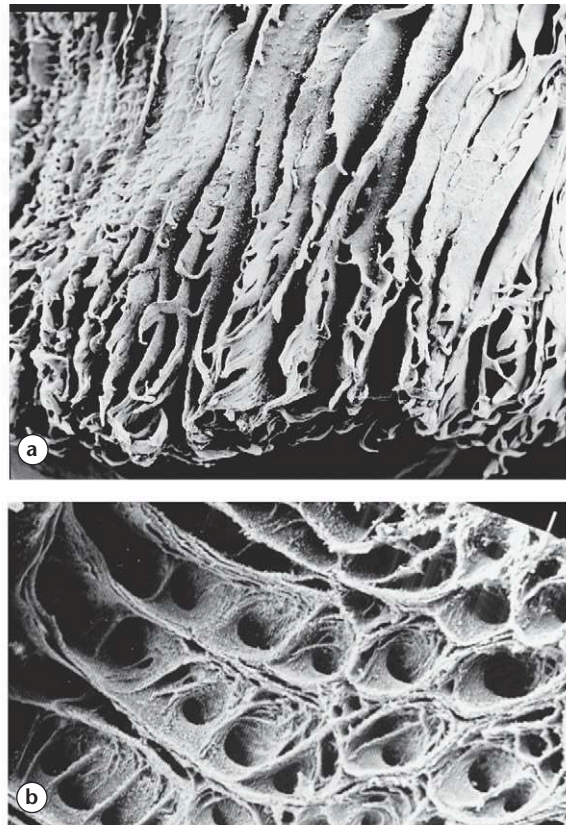
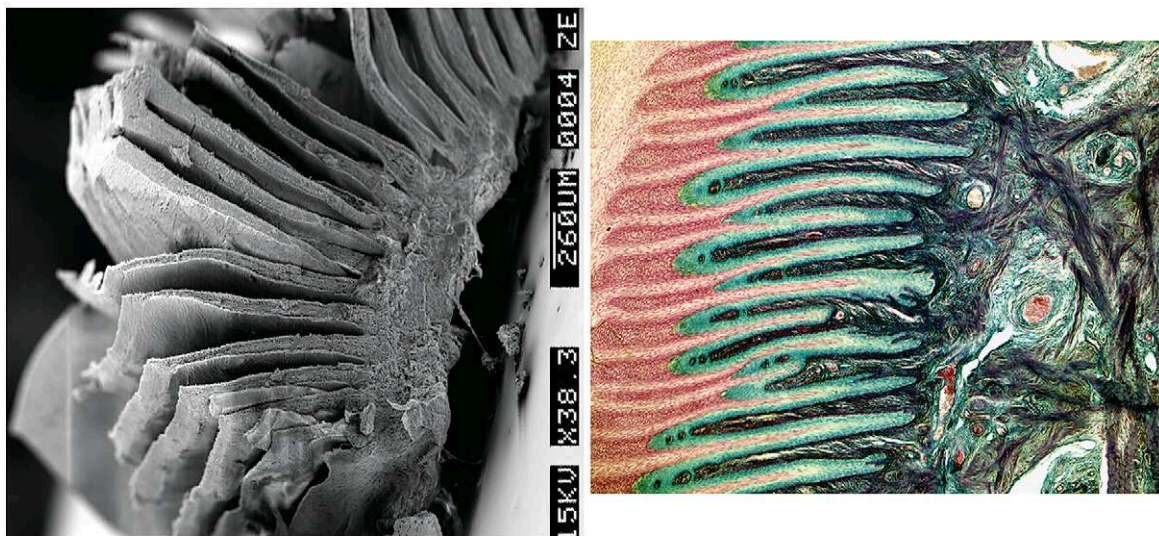


Figure 2-18 (a) The upper scanning electron micrograph shows the shape of the epidermal lamellae (horn leaflets). The dermal lamellae (laminae) are mirror images and make up the modified shapes equivalent to papillae. (b) The lower scanning micrograph shows the proximal openings to the tubules of the wall. The structures to the left of the image are the proximal ends of the epidermal lamellae. (Courtesy of C K W Mülling)



**Figure 2-19** The lamellae are leaflets of the epidermis lining the inner distal surface of the wall. They cornify and turn into horn lamellae towards the surface. The lamellae continuously get shorter towards the heel. The dark red groupings of mitotic cells are referred to as caps. (Courtesy of C K W Mülling)

The average thickness of the sole of a normal mature cow is approximately 5–7mm in region 5 (anterior part of the sole) and 15mm in region in region 4 (Fig. 17-8). Following claw trimming the thickness of the sole should not be less than these guideline dimensions.

The distribution of the tubules in the sole is less dense than it is in the wall. All of the tubules slope forward in alignment with (parallel to) the slope of the dorsal wall. In some cases of sole hemorrhage, blood may diffuse down the tubules giving the stain a brush-mark appearance.

In cattle on pasture the sole experiences little wear. Under low wear conditions it has been proposed that the distal ends of the tubules may become blocked. Lack of moisture in the superficial layers of the sole could account for the natural flaking of the horn sometimes seen in pastured cows. This hypothesis is unproved but there must be some simple explanation for the natural flaking process. A 'self-flaking mechanism' has been described in wild ungulates. Progressive loss of the adhesive function of the intracellular cementum as it nears the surface of the sole is believed to contribute to this process.

In cattle confined on concrete where the sole is subject to rapid wear the tubules are open to the surface. Tubules are only really patent if the medullary debris falls out. Experimental evidence shows that moisture from the environment can rise along the tubules by capillary action. It is useful to refer to this as exogenous moisture. Moisture in the sole supplied by diffusion from

the dermis or via the tubules would be considered as endogenous moisture. The overall moisture content of the sole is a major factor with regard to how hard and resistant it may be.

The normal rate of growth of the sole has not been documented. However, it is almost certainly variable under conditions of intensive management. The greater the wear and the higher the pressure on the dermis the more rapidly will horn be produced. This is of clinical importance. If blood escapes from the vessels of the dermis it will stain the horn. The stain will not appear on the surface of the sole for 6–10 weeks after the escape of blood has occurred. It is, therefore, important to recognize that a sole hemorrhage associated with laminitis is an historical event and certainly not of recent origin.

### **Bulb of the Heel (Bulbar Segment)**

This refers to zone 6 of the claw capsule and lies directly posterior to zones 3 and 5 (Fig. 17-8). The anterior border of the bulb is a strip of thick horn referred to as the bar or pad. The bar is the first structure to take the forces of concussion during locomotion. These forces are transmitted upwards to the 'Pedal Bone Support System' (p. 20). The posterior and flexor aspects of the bulb are rounded, smooth and composed of soft and elastic, rubber-like horn. Papillae and small tubules are distributed sparsely throughout the matrix.

See Figure 2-20.

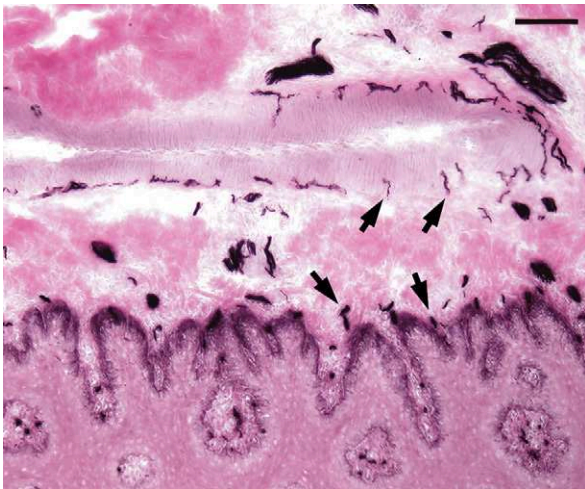


Figure 2-20 The dermis of the bearing surface of the bulb is richly supplied with nerves (arrows). (Courtesy of C K W Mülling)

### The White Line (*Zona Alba*)

The white line or *zona alba* is a vulnerable and unstable junction between the wall horn and the sole horn; it acts like a hinge between these two horn masses of different origin and biomechanical characteristics. The white line is composed of very soft horn which has only 20% of the hardness of wall (coronary) horn and is susceptible to several different types of lesions. The lesions fall into two classes. The first is that in which direct trauma causes an external lesion. The second occurs after the white line has been previously weakened by a laminitis-like episode. The lesions associated with 'previous weakening' such as a retroarticular abscess are described on page 93.

Under intensive dairy management very few cows will have white lines that are completely healthy. A very important factor is the loading status of the claw. If the claw is overloaded due to lack of trimming a simple white line defect will become much more serious and the prognosis will be poor.

## OTHER FUNCTIONAL FEATURES OF THE CLAW

### GLOSSARY

**Retinaculum:** This is a 'special fibrous thickening that holds back a part.'

### The Coronary Cushion (*Pulvinus Limbi*)

The coronary cushion is a system of fat cushions organized and compartmented by connective tissue beneath the coronary band. It includes a network of veins containing valves which direct the flow of blood from the foot back into the systemic circulation. It is suggested that when the animal walks, the vessels are squeezed between the wall and the distal phalanx. This action probably pumps stale blood from the claw, returning it to the systemic circulation. This function is, of course, closely related to exercise and is an important consideration in management systems that restrict exercise.

See Figures 2-21 and 2-22.

### Structures that Maintain the Pedal Bone in Position inside the Claw Capsule

Two systems hold the pedal bone in its proper position in the space inside the claw capsule – the suspensory apparatus of the digit and the support system of the pedal bone. Both systems depend on collagen fibers to maintain their function and both are susceptible to degradation by MMPs. Failure of these structures causes the orientation of the pedal bone to move (to sink, to rotate, or to be displaced).

### The Suspensory Apparatus of the Digit

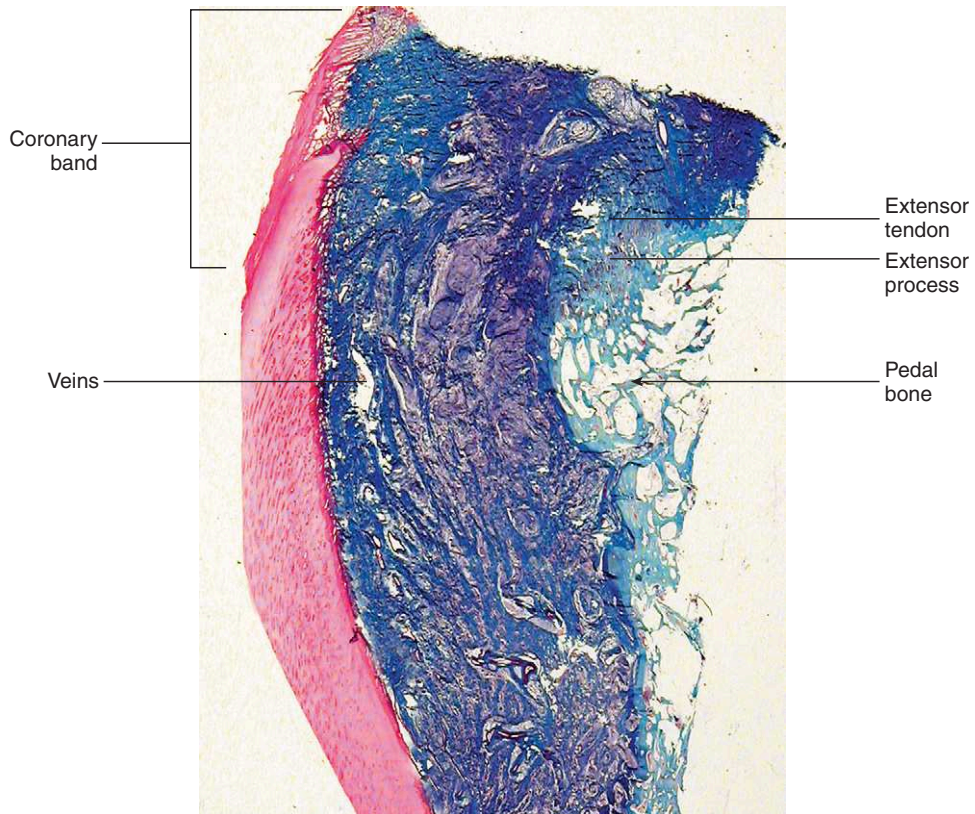
The suspensory apparatus consists of collagen fibers that insert into the pedal bone on one side and are anchored to the basement membrane of the dermal lamellae on the other side. It is responsible for transferring the load (weight of the animal) on the pedal bone to the claw capsule. Fibers that run upwards from the pedal bone are suspending the pedal bone. Fibers running forward take the drag as the animal propels itself forward.

See Figures 2-23–2-26.

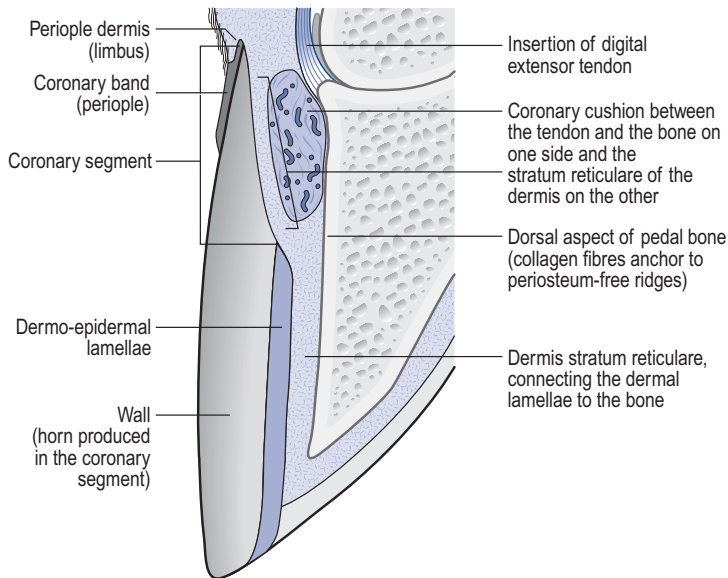
### Pedal Bone Support System (PBSS)

This term has been introduced to describe the digital retinaculum and the fat bundles of the digital cushion which it envelops (see below). The rationale for using this term is that the distal interphalangeal ligament (cruciate ligament) consists of two functionally different parts:

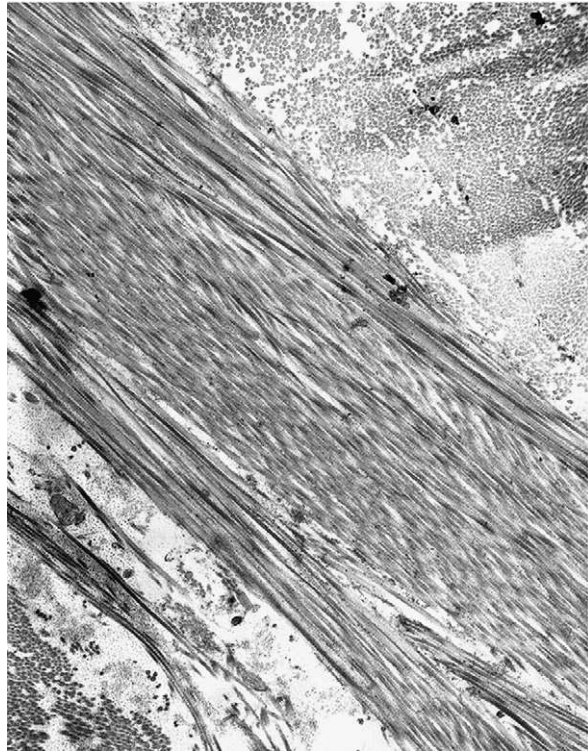
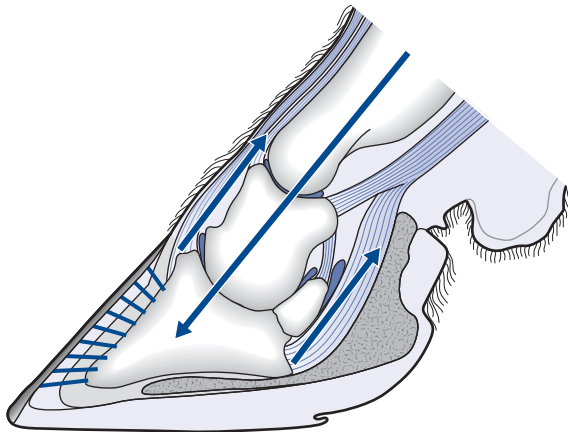
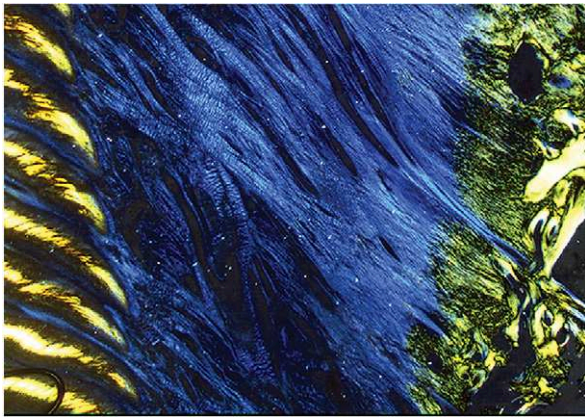
- *The true cruciate ligament* which prevents the two digits from separating.
- *The retinaculum of the digit* which is a fibroelastic envelope binding the digital cushion and deep



**Figure 2-21** The coronary cushion (CC) is composed a network of veins and elastic fibers. During locomotion when the bone squeezes the cushion against the claw wall it serves as a pump to facilitate the perfusion of blood through the digits and its return to the general circulation. (Courtesy of C K W Mülling)



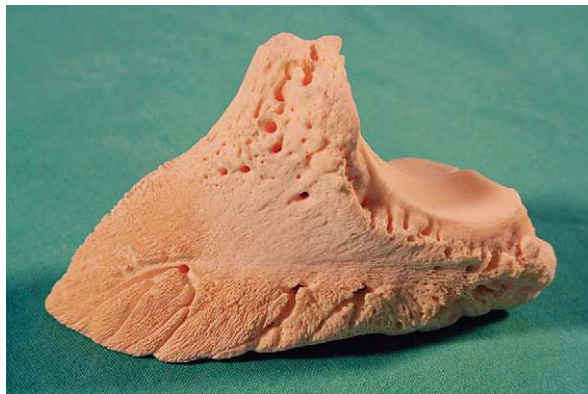
**Figure 2-22** The coronary cushion occupies significant space beneath the dermis of the coronary band. (Courtesy of C K W Mülling)



**Figure 2-23** The support system of the pedal bone is most extensive on the inner dorsal surface of the claw where the epidermal lamellae are longest. The dermal lamellae considerably increase the surface area to which supporting fibers are attached. The pedal bone literally hangs from these fibers which are compromised when MMPs are released during an episode of laminitis. (Courtesy of C K W Mülling)



**Figure 2-24** A faint groove running parallel to the ground surface of this pedal bone marks distinct transition of function. Distal to the groove are ridges for the attachment of the suspensory apparatus of the digit. The ridges are more intensely represented on the dorsal surface of the bone and in fact extend upwards towards along the dorsal flexure almost to the extensor process. The bone proximal to the groove is smooth and covered with periosteum. (Courtesy of C K W Mülling)



**Figure 2-25** This is the pedal bone from an older cow than in Figure 2-24. Note that the dorsal surface is more concave and significantly rougher. This suggests that the 'pull' of the suspensory apparatus of the digit has been involved and that functional adaptation of tissues (causal histogenesis) probably has taken place. (Courtesy of C K W Mülling)



**Figure 2-26** Periosteum is only present in the depths of the groove indicating that the collagen fibers are anchored directly into the bony prominences of the ridges. (Courtesy of C K W Mülling)

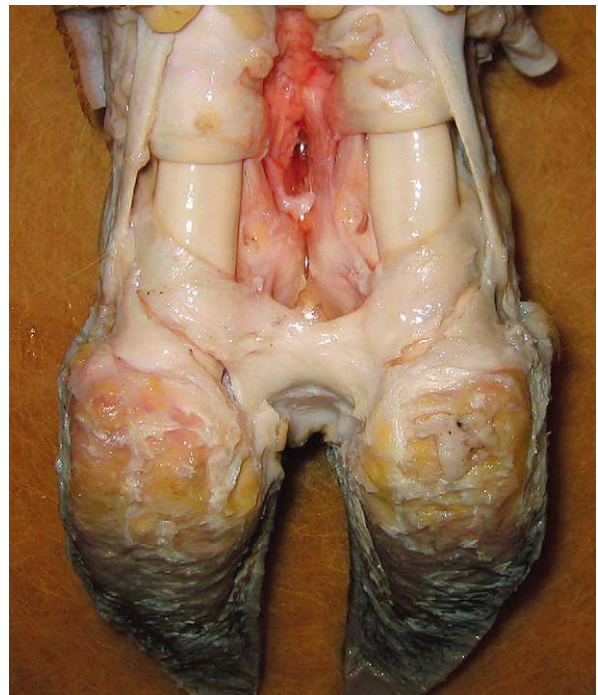
flexor tendon to the bony structures that make up the pedal joint. This structure merges with the true cruciate ligament and inserts into the axial, abaxial, and solear surfaces of the pedal bone.

See Figures 2-27 and 2-28.

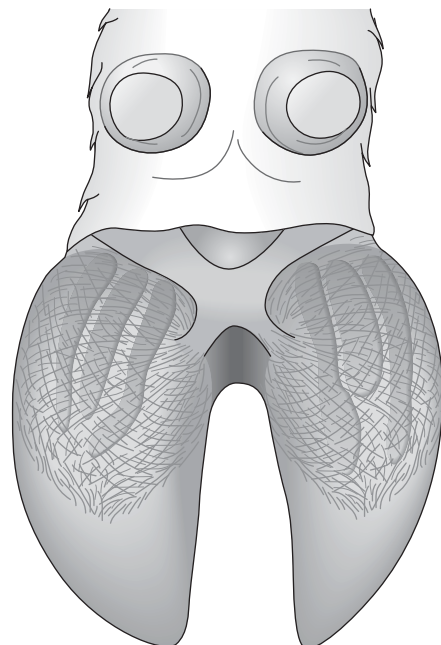
### The Digital Cushion (*Pulvinus Digitalis*)

The bulk of the digital cushion lies behind the pedal joint with a slim portion extending forward beneath the pedal bone. It is made up of three cylindrical parallel oriented bodies, each with a capsule of connective tissue filled with soft fat (Fig. 2-29). The fat content is significantly higher in cows (38%) than in heifers (27%). There is a marked change in the composition of the cushions as the animal gets older. It is estimated that the development of the digital cushion is not complete before the animal is 3 years old. The fatty acid composition and the size of the fat cushions change under the influence of metabolic disorders, in particular in cows with lipid mobilization syndrome (LMS, ketosis.) There is significantly more arachidonic acid in the cushions of heifers. Arachidonic acid is a precursor of prostaglandin, a pro-inflammatory mediator.

The digital cushion functions as a shock absorber acting in conjunction with the retinaculum of the digit and surrounding soft-elastic horn of the bulb. The elastic tissues of the retinaculum expand laterally when compressed during weight-bearing. The lateral pressures are transferred to the wall which normally has high tensile strength functioning as a spring to absorb



**Figure 2-27** Dissection of the cruciate complex showing its relationship to the digital retinaculum. (Courtesy of C K W Mülling)

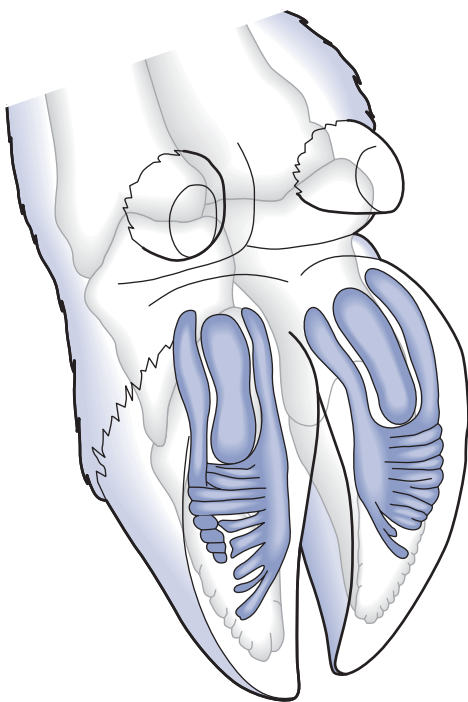


**Figure 2-28** A sketch representing the attachment of the pedal bone support system.

some of the energy of locomotion. This tensile strength of the wall is diminished if the quality of the horn of the wall is compromised by disorders such as subclinical laminitis, horizontal or vertical fissures, or heel erosion.

Normally, once the compressive force is reduced the elasticity of the retinaculum will assist in restoring the cushion to its normal configuration. The fibers of the posterior portion of the suspensory apparatus of the digit undoubtedly merge with the retinaculum.

Most of the factors leading to activation of MMPs in laminitis circulate with the blood and will activate MMPs in any connective tissue within the organism. The degradation of collagen is particularly fatal in the claw because of the high mechanical load of the suspensory apparatus. The collagen of the digital retinaculum will also be altered by MMPs. This will tend to account for lowering of the heel and may be a factor in the tissue disruption associated with white line disease.



**Figure 2-29** The cushion is composed of three cylindrical parallel-oriented bodies each with a capsule of connective tissue filled with soft fat. Towards the tip of the pedal bone a system of thin transverse oriented fat strands is present in continuity with the fat cylinders. (Courtesy of C Lischer & P Ossent)

## THE FLOW OF FORCES THROUGH THE CLAW

Recent observations of the microstructure inside the claw combined with known features of locomotion and recent treadmill locomotion studies lead to the following conclusions:

- The hind foot touches the ground with the lateral heel bulb first (Fig. 2-30).
- The digital cushion/retinaculum is not directly related to the suspensory apparatus of the digit.
- The suspensory apparatus of the digit covers very little surface area starting at the abaxial groove and increasing dramatically towards the dorsal surface, where there is evidence that it has the maximum weight-bearing function (Fig. 2-31).
- The coronary cushion absorbs compression occurring in the final stage of the stride when the pedal bone is forced forward towards the wall and the dorsal part of the capsule is pulled inwards due to the loading of the suspensory system. In functional synergy with the suspensory apparatus and the digital cushions the coronary cushion stabilizes the position of the pedal bone inside the claw capsule.

If these observations are correct it can be hypothesized that during locomotion the forces are first dissipated by compression of the digital cushion/retinacular complex, it flows forward naturally into suspensory apparatus of the digit, and is finally absorbed by the bending and flexing capacity of the horn of the wall and the coronary cushion.

See Figures 2-30 and 2-31.

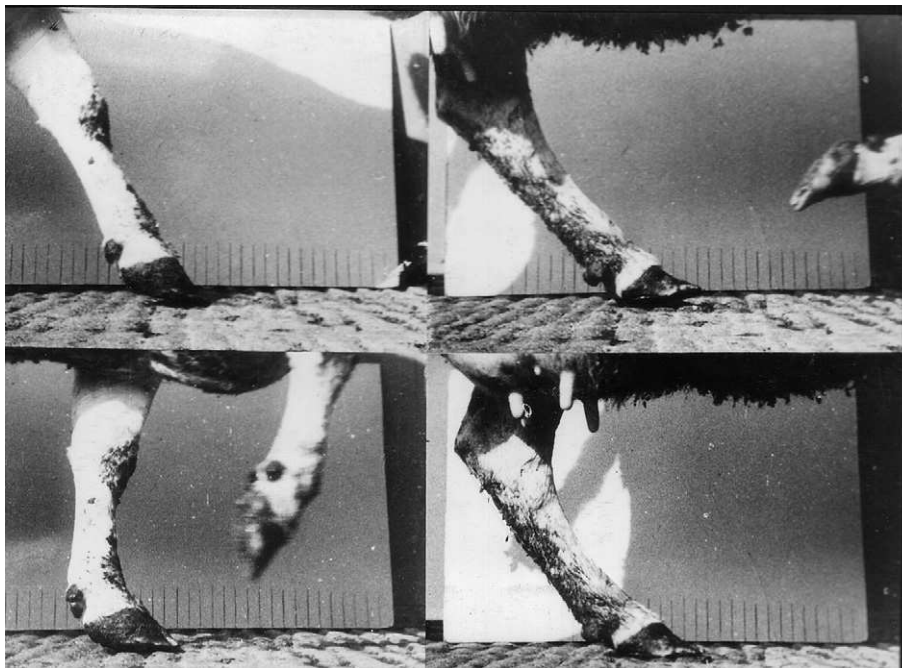
### TECHNICAL COMMENTS

When matrix metalloproteinase expression is unregulated by proinflammatory cytokines, endotoxins, or other bioactive molecules, the active MMPs start degrading collagen fibers. The fiber system is weakened, resulting in loss of function. An increased mobility of the pedal bone within the capsule causes sinking and/or rotation or tilting or a combination of these movements of the bone – to a degree depending on the localization and severity of the collagen degradation. Another factor influencing the displacement of the pedal bone is believed to be

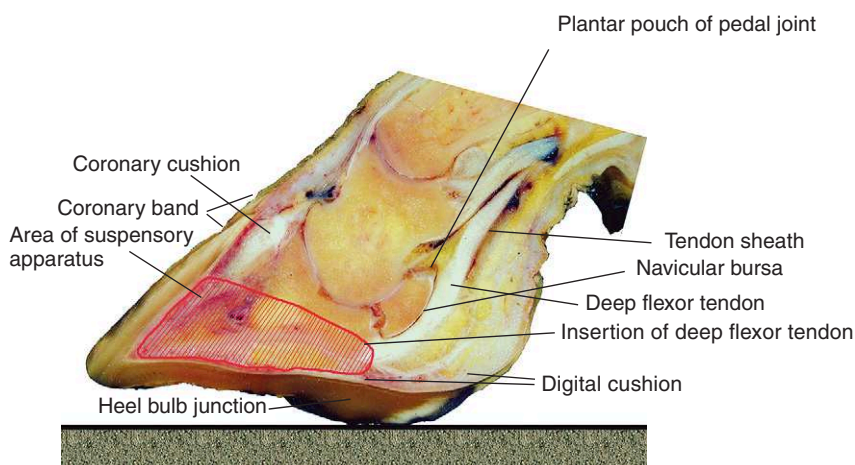
periparturient hormone, relaxin. Other hormones may also be involved in alterations of the connective tissue of the pedal bone support system.

TIMPs (tissue inhibitors of MMPs) normally prevent excessive MMP activity. In disease, simply put,

too much MMP is produced and transformed into its active form. TIMPS can no longer control MMPs while, at the same time, cytokines also down-regulate TIMPS which makes MMP degradation even more efficient, i.e., destructive.



**Figure 2-30** In the top left hand picture the front foot can be seen touching toe first at the beginning of each stride. In the picture beneath the limb is fully weight-bearing and is in a vertical position. The picture on the top right hand side shows the heel of the hind foot touching the ground first. The picture below suggests that weight-bearing takes place with the limb at an angle to the ground. It should be noted that the hindlimb bears only 40% of an animal's weight and that propulsive forces are active on the claw. The forelimb functions mostly as 'prop.'



**Figure 2-31** The bulk of the digital cushion/retinaculum is located behind the joint and is fused to the deep flexor tendon. This structure, in the hind foot, is compressed during the first phase of a stride. The suspensory apparatus of the digit (marked in red) is only present in the anterior two-thirds of the wall. Therefore, the forces generated by weight-bearing flow forward as the bearing surface of the claw impacts the ground. During the propulsion take-off phase of a stride the coronary cushion is compressed and in so doing transfers pressure onto the dorsal wall which flexes in order to absorb energy. (Courtesy of C K W Mülling)



**THE MICROVASCULATURE SUPPLYING THE DERMIS (PODODERM, CORIUM, OR QUIK)**

**GLOSSARY**

**Anastomosis:** The intercommunication of blood vessels by natural anatomic arrangements which provide alternative pathways for blood supply to a peripheral part. They are variable in diameter and function as shortcuts or bridges between two blood vessels. They regulate the perfusion rate of the capillary bed of a peripheral vascular system.

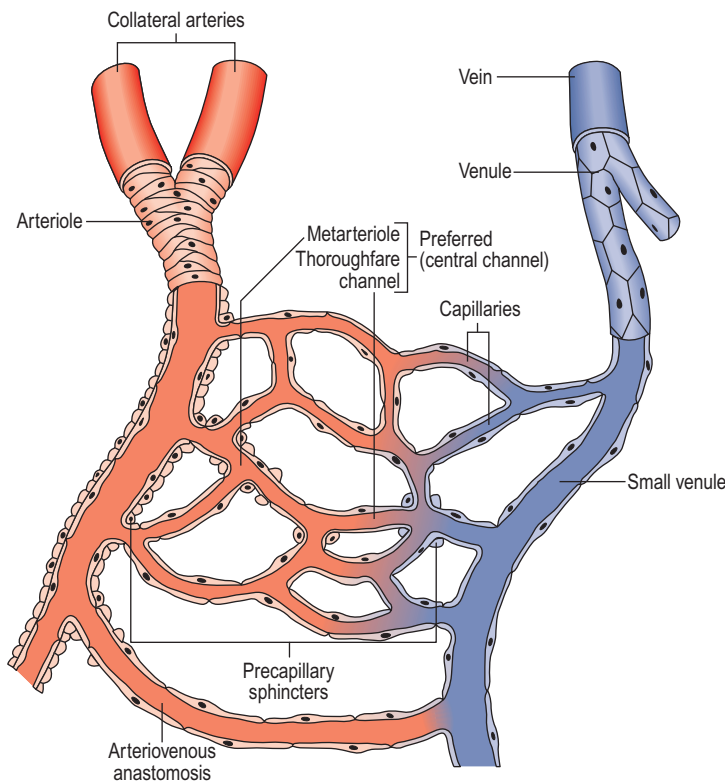
**Arteriovenous Anastomosis (AVA)**

Arteriovenous anastomoses are present in the skin where they play an important role in thermoregulation. They are also present in the dermis of the claw. The number of AVAs in the dermis of the claw depends on functional challenges. That is to say, the number of AVAs increases in diseased claws, e.g. during laminitis

and around the periphery of sole ulcers. AVAs are shunts between the arterioles bringing the blood into the capillary bed and the venule draining the blood from the capillary bed. (See Figure 2-32.) They are supplied with nerves which innervate smooth muscle in vessel walls and thus allow opening and closure of AVAs to regulate perfusion of the capillary bed of the dermis. The prime function of an AVA in the claw is believed to be to control temperature. It has also been suggested that AVAs may function as a mechanism to accommodate changes in intra-ungular pressure during weight-bearing.

When functioning normally the venous end of the AVA has a larger diameter than the arterial end of the bridge. Some AVAs are referred to as 'thoroughfare channels' which, as the name implies pass blood directly from arteriole to venule and are particularly prevalent in papillae.

'Sphincteric' arteries are structures which regulate the rate of blood flow whereas an AVA directs blood flow to or withholds blood from specific areas. The sphincteric artery functions by changing its diameter and allowing the rate of blood flow to be modified according to actual functional needs. The existence of these specialized structures highlights the importance of blood flow regulation for a proper physiological function of claw tissues.



**Figure 2-32 Diagrammatic representation of an arteriovenous shunt.** In this instance the shunt is open, directing blood away from the vascular bed. The opening and shutting of the shunt is brought about by smooth muscles which are controlled by the autonomic nervous system.

**TECHNICAL COMMENTS**

by Ruth Hirschberg

It is important to stress that the dermal microvascularization and the perfusion patterns at any given time are very adaptable to metabolic and functional requirements (i.e., by mechanisms of angioadaptation).

The overall microvascular pattern of the dermal papillae and lamellae is quite extensive, but not all branches of this microvascular bed are perfused at all times. Therefore, a basic or primary 'nutritional' pathway (supplying the dermal cells and the adjacent epidermal cells with their basic needs, i.e., maintenance supply) has to be differentiated from the 'functional' microvascular pathway which responds to the functional demands required from the dermis and epidermis (e.g., region-specific proliferation rate, keratinization, cornification etc.). The actual perfusion pattern is tuned to the dermo-epidermal needs by precapillary sphincter mechanisms rather than arteriovenous anastomoses. It is important to not confuse real arteriovenous anastomoses with metarteriolar and thoroughfare channels within the microvascular bed.

The so-called 'thoroughfare channels' are main pathways within the capillary bed. Within the papillae, this basic nutritional pathway is represented by the central papillary arteriole and venule connected by a

long peripheral capillary loop at the tip of the papilla. The functional pathway required for proper supply of the adjacent highly keratinizing and cornifying epidermal layers is provided by the extensive peripheral capillary network of the papilla. The mechanical forces acting on such structures as the spring-like shaped papillae of the bulb also take part in regulating the perfusion pattern. Compression and tearing forces occurring during weight-bearing deform the papillae and may thus deviate or open certain microvascular pathways within the papillae. Thus, the perfusion pattern of the microvascular bed is regulated according to demand and mechanical forces.

On the other hand, the microvascular angioarchitecture itself may adapt to the demands and mechanical forces by active remodeling processes within the microvasculature such as capillary sprouting and capillary remodeling.

Real arteriovenous anastomoses (by definition) are situated outside (or prior to) the microvascular bed and regulate extreme demands for perfusion. Therefore, they occur at the base of the lamellae and papillae and in the deeper layers of the connective tissue of the claw rather than within the lamellae and papillae. These arteriovenous anastomoses are also subject to function-related remodelling and are formed on demand that is, mostly in response to changes in the environmental temperature.

There is no evidence to support the theory that AVAs play a leading role in the pathogenesis of laminitis. However, pressure in the vessels and tissues increases during laminitis. This could be explained by compromising the function of AVAs – or more likely by blood clots (coagulopathy). The pressure increases in the capillaries together with transvascular movement of fluid in tissues may be caused by an increased post-capillary resistance. This resistance is believed to be the result of a reduction in the diameter of the venules in the periphery draining blood from the capillary bed.

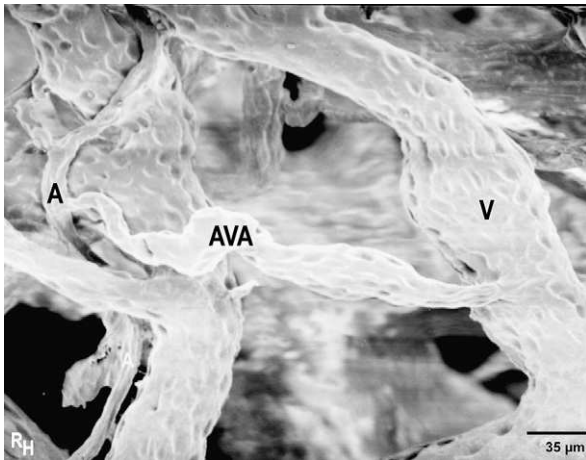
A single cause and single pathological explanation of laminitis which has been long known to be a multifactorial disease is highly unlikely, if not impossible. Undoubtedly a combination of pathomechanisms is involved. The initial local 'reactions' to laminitis that takes place in claw tissues are:

(a) alterations in the vascular endothelial lining (roughening)

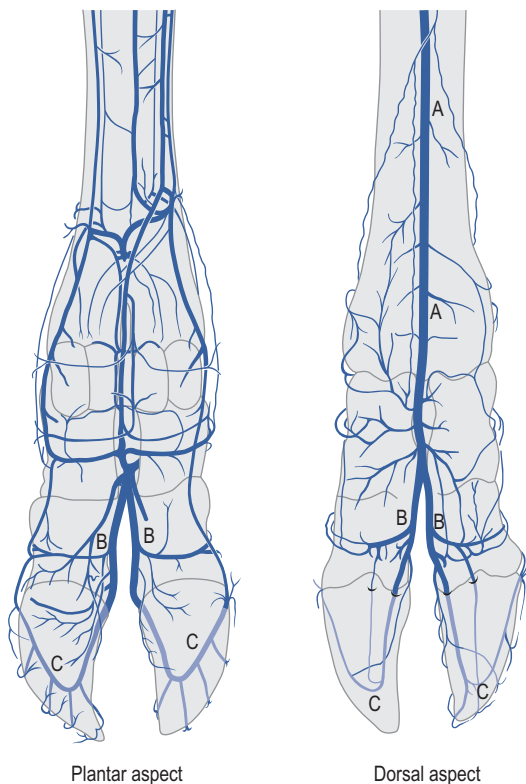
(b) alterations in the microcirculation (changes in the rate of perfusion).

These events are followed by the activation of a variety of interacting and cross-linked inflammatory and regulatory cascades. MMP activation is only one part of the jigsaw. It also may be that there is initial damage to the epidermis, e.g. by mechanical overload. The damage will cause the release of interleukin-1 (IL1) which is a potent proinflammatory cytokine produced and stored by the epidermal cells. IL1 will then diffuse into the dermis, binding to fibroblasts and triggering the release of keratinocyte growth factor (KGF). KGF is a potent mitogen activating basal proliferation in the epidermis. Parallel to this, IL1 also activates MMPs. In addition there is positive and negative feedback between these autocrine and paracrine regulations. These observations strongly support the idea of complex rather than a simple pathogenesis. Any hypothesis reducing everything to the one and only magic factor or molecule is highly suspicious.

See Figures 2-33 and 2-34.



**Figure 2-33** Short arteriovenous anastomoses connecting lamellar arteriole (A) and lamellar venule (V) at the base of a pododermal lamella. Scanning electron microscopy, micro-corrosion cast. (Courtesy of R M Hirschberg)



**Figure 2-34** The terminal arch feeds the marginal arterial plexus (circumferential artery). (A) Dorsal pedal artery, (B) axial plantar arteries, and (C) terminal arch. The point at which the small vessels leave the bone is a common site of mural thrombi. (After N de Vos)

## BIBLIOGRAPHY

- Ackerman N, Garner H E, Coffman J R, Clement J W 1975 Angiographic appearance of the normal equine foot and alterations in chronic laminitis. *Journal of the American Veterinary Medical Association* 166:58–62
- Allen D, Clark E S, Moore J N, Prasse K W 1990 Evaluation of equine digital, Starling forces and haemodynamics during early laminitis. *American Journal of Veterinary Research* 51:1930–1934
- Baggot D G, Bunch K J, Grill G R 1988 Variations in some inorganic components and physical properties of claw keratin associated with claw disease in the British Friesian cow. *British Veterinary Journal* 144:534–542
- Banks W J 1993 In: *Applied Veterinary Histology*, 3rd edn. Mosby Year Books, St. Louis, USA
- Buda S, Mülling Ch K W 2000 Innervation of the bovine hoof. *Proceedings of the XI International Symposium on Lameness in Ruminants*, Parma, Italy, p 100–101
- Budras, K-D, Mülling Ch K W, Horowitz A 1996 The rate of keratinization of the wall segment of the cattle hoof and its relationship to width and structure of the zona alba (white line) with respect to claw disease. *American Journal of Veterinary Research* 57:444–555
- Budras K-D, Geyer H, Maierl J, Mülling Ch K W 1998 Anatomy and structure of hoof horn. *Proceedings of the X International Symposium on Lameness in Ruminants*, Lucerne, Switzerland, p 176–188
- Boosman R, Németh F, Gruys E, Klarenbeek 1989 Arteriographical and pathological changes in chronic laminitis in dairy cattle. *Veterinary Quarterly* 11:144–155
- Dellman H D, Brown E M 1976 *Textbook of veterinary histology*. Lea and Febiger, Philadelphia
- De Vos N, Morcos M B 1960 De arteries van de achervoet bij het rund. *Vlaams Diergeneeskundig Tijdschrift* 29:241–246
- Dietz O, Naumann J, Prietz G 1986 Inorganic composition and physical properties of bovine digital horn. *Proceedings of the 5th International Symposium on Disorders of Ruminant Digit*, Dublin, Ireland, p 24–31
- Dietz O, Prietz G 1987 Klauenhornqualität – Klauenhornstatus. *München Veterinar Medizin* 36:419–422
- Dyce K M, Sack W O, Wensing C J G 1987 *Textbook of veterinary anatomy*. W D Saunders, Philadelphia
- Ellenberger-Baum 1977 *Handbuch der vergleichenden anatomie der haustiere*. Springer-Verlag, Berlin
- Fürst A 1992 Makroskopische und mikroskopische Anatomie der Rinderklaue. *Dissertation Medizin Veterinaria*, Zürich
- Hirschberg R M 1998 Microvasculature of the bovine claw. *Proceedings of the X International Symposium on Lameness in Ruminants*, Lucerne, Switzerland, p 204–207
- Hirschberg R M, Mülling Ch K W, Bragulla H 1999 Microvasculature of the bovine claw demonstrated by improved micro-corrosion-casting technique. *Microscopy Research and Technique* 45:184–197
- Hirschberg R M, Mülling Ch K W, Budras K-D 2001 Pododermal angioarchitecture of the bovine claw in relation to form and function of the papillary body. A scanning electron microscopic study. *Microscopy Research and Technique* 54:375–385

- Hirschberg R M, von Süsskind-Schwendi M, Bragulla H, Budras K-D 2005 'Form follows Function' – neue Erkenntnisse über das Unterhautgewebe des Zehenendorgans. Proceedings of the 26th Congress of the Deutsche Veterinärmedizinische Gesellschaft, DVG, Berlin
- Mülling Ch K W 1993 Struktur, Verhornung und Hornqualität in Ballen, Sohle und Weißer Linie der Rinderklaue und ihre Bedeutung für Klauenerkrankungen. Berlin, Freie Univ., Fachber. Veterinärmed., Diss
- Mülling Ch K W, Lischer Ch 2002 New aspects on etiology and pathogenesis of laminitis in cattle. In: Kaske M, Scholz H, Höltershinken M (eds) Recent Developments and Perspectives in Bovine Medicine: keynote lectures of the XXII World Buiatrics Congress, p 236–247
- Mülling Ch K W, Budras K-D 2002 The dermo-epidermal junction in the bovine claw in relation to its biological function. Wiener Tierärztliche Monatsschrift 89:188–196
- Mülling Ch K W, Bergsten C 2004 Some reflections on research on bovine laminitis – Aspects of clinical and fundamental research. Proceedings of the 13th International Symposium on Lameness in Ruminants, Maribor/Slovenia, p 53–60
- Mülling Ch K W, Budras K-D 2003 The hoof (ungula). In: Budras K-D (ed) Bovine anatomy – an illustrated text. Schlütersche, Seiten, Hannover, p 26–27
- Nickel R, Schummer A, Seiferle E 1981 In: The anatomy of domestic animals, Vol. 3 The circulatory system, the skin and the cutaneous organs of domestic mammals. Springer-Verlag, New York, p 524-536
- Nomina Anatomica Veterinaria, 4th edn 1994 International Committee on Veterinary Gross Anatomical Nomenclature, Ithaca, New York
- Pollitt C C 1992 Clinical anatomy and physiology of the normal equine foot. Equine Veterinary Education 4:219–224
- Pollitt C L, Molyneux G S 1990 A scanning electron microscopical study of the dermal microcirculation of the equine foot. Equine Veterinary Journal 22:79–87
- Prasse K W, Allen D, Moore J M, Duncan A 1990 Evaluation of coagulation and fibrinolysis during the prodromal stages of carbohydrate-induced acute laminitis in horses. American Journal of Veterinary Research 12:1950–1955
- Raeber M 2000. Das ballenpolster beim Rind. Ein Beitrag zur funktionellen anatomie der klaue. Dissertation Medicina Veterinaria, University of Zürich, Switzerland
- Raeber M, Scheeder M R L, Geyer H, Lischer Ch J, Ossent P 2002 The influence of load and age on the fat content and the fatty acid profile of the bovine digital cushion. In: Proceedings of the XII International Symposium on Lameness in Ruminants, Orlando, Florida, USA, p 194–198
- Reilly J D, Cottrell D F, Martin R J, Cuddeford D 1996 Tubule density in equine hoof horn. Biomechanics 4:23–36
- Tomlinson D J, Mülling Ch K W, Fakler T M 2004 Formation of keratins in the bovine claw: roles of hormones, minerals, and vitamins in functional claw integrity. Journal of Dairy Science 87:797–809
- Vermunt J J, Leach D H 1992 A scanning electron-microscopic study of the vascular system of the bovine hindlimb claw. New Zealand Veterinary Journal 40:146–154

# Characteristics of Lameness

### GLOSSARY

**Stride:** The forward/backward motion of a limb consisting of a forward phase (protraction), a weight-bearing phase, and a backward phase (retraction).

**Gait:** The complete characteristics of a step, including the stride and swinging of the limb out or with respect to the midline of the animal.

**Camping Forward:** This is a sign of abnormal walking when one or both front or hind feet are carried further forward than normal (protraction).

**Camping Back:** A sign of abnormal walking when one or both front or hind feet are carried further back than normal (retraction.)

**Tracking:** The actual path taken by each foot during each step.

**Seat of Lameness:** The point in the limb or in the foot which is the location of the source of pain, causing the animal to be lame.

**Stance:** A cow normally stands with the point of the hock directly beneath the pin bone (*tuber ischiadicum*). Changes in stance caused by an animal's effort to gain relief from a painful stimulus can be referred to as a clinical posture.

## RECOGNIZING THE CHARACTERISTICS OF LAMENESS

### KEY CONCEPTS

- *Always* observe cows walking on level concrete (firm, non-slippery ground surface) in order to detect lameness. A cow has to be extremely lame before it is noticeable on sawdust or straw-bedded yards (Fig. 3-1).
- A person who is skilled in recognizing lameness will observe 2.5× more lame cows than an unskilled person.
- Observe the observable.
- Farmers significantly underestimate the level of lameness in their herds; about 1 in 5 lame cows go undetected. Cows are quite tolerant of pain; therefore, the causal lesion can reach an advanced stage before it is detected. If cows can be treated in the early stages of lameness, the chances for a successful treatment without severe damage, reduced performance, and economical loss, the loss to the farmer will be improved.
- A cow should be observed from each side, from in front and behind, when standing quietly and also when walking. The animal should then be observed as it turns first to the left and then to the right.



Figure 3-1 A cow has to have a serious lesion for it to be extremely lame if walking on deep bedding. (Courtesy of R Shaver)

## NORMAL GAIT

There are three 'phases' in each stride:

- *The weight-bearing phase.* During the weight-bearing phase, the bearing surface of heel-bulb junction of a hindlimb normally touches the ground first. This is followed by the abaxial part of the weight-bearing margin of the wall and then the toe. Finally, the bearing surface of the claw will slide forward to an extent, depending on the friction generated by the ground surface.



Figure 3-2 This cow is protracting its hind feet (camping forward) and its fore feet are retracted beneath the body (camping back). This posture is typical of acute laminitis. (Courtesy of K Mortensen)



Figure 3-3 This cow is retracting her hindlimbs (camping back.). This is usually a sign of pain in the heel bulbs or posterior region of the sole. It may also be characteristic of arthritis of the hip, in which case muscle wastage will be seen around the rump. (Courtesy of Anon)

- *The protraction phase* is when the limb swings forward and then back to weight-bearing.
- *The retraction phase* is the backward swing of the limb.

A cow walks with a level spine and places her hind feet almost exactly onto the same spot as the fore feet.

### On which foot is the cow lame?

A cow that is lame will hold its head lower than normal. Less time will be spent bearing weight on the affected limb. The stride will be shortened. Holding the less painful side of the rump (or shoulder) higher than normal indicates pain in that limb.

If lame in a front foot, the head will move higher each time the animal bears weight on the affected foot.



**Figure 3-4** When a cow swings its limb away from the body it is attempting to relieve pain in the outside (lateral) claw. This is 'swinging leg lameness.'

Pain in a hind foot causes the hip on that side to be lifted higher than normal. Some degree of head lifting may be seen when the unaffected hind foot touches the ground. Also, the lame leg may swing outwards to avoid bearing weight on a painful lateral claw.

### CHANGES IN STANCE OR GAIT CAUSED BY PAIN (I.E., LAMENESS)

Camping forward, when walking, often indicates pain in the apex of the claw. Camping forward is sometimes confused with sickle-hocked conformation of the hindlimb.

See Figures 3-2–3-12.



**Figure 3-5** If an animal stands or walks with its feet close together it is 'walking narrow.' This is often the sign of the seat of lameness being located in the inside (medial) claw. Cattle with subclinical laminitis mainly in the medial claws will walk narrow.



Figure 3-6 Crossing either the fore or hind feet is indicative of the most acute pain. (Courtesy of R Shaver)



Figure 3-7 Fracture of the pedal bone, laminitis in a medial claw, or an acute abscess in the medial claw can cause this change in posture or gait.



Figure 3-8 Knuckling at the fetlock is an attempt to relieve pain in the heel. The toe hits the ground first; then the fetlock flexes in order to allow the heel to impact the ground more gently.



Figure 3-9 Hanging leg lameness is a reaction to extreme pain as would occur from septic arthritis of the pedal joint or a fractured pedal bone.





Figure 3-10 An animal that has a very straight limb (post legged) will take short strides but is not necessarily lame. This characteristic of conformation can be confused with 'Elsø Heel.'



Figure 3-11 Cattle that are reluctant to rise on the forelimbs when they have very acute laminitis are often referred to as 'crawlers.' (Courtesy of K Mortensen)



Figure 3-12 Turning-in of the hocks is referred to as 'Cow Hock' posture (a) and is caused by the heel of the lateral claw becoming much thicker than normal (b). This phenomenon is referred to as 'overburdening' of the heel.

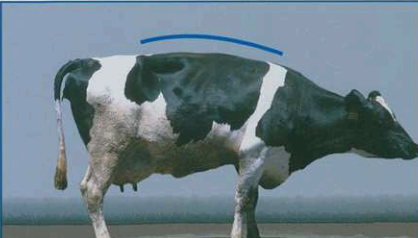
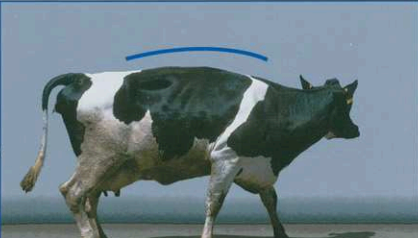
<p><b>LOCOMOTION SCORE</b> <b>1</b></p> <p>Clinical Description</p> <p><b>NORMAL</b></p> <p>Description: Stands and walks normally. All feet placed with purpose.</p>	 <p>Back Posture Standing: Flat</p>	 <p>Back Posture Walking: Flat</p>
<p><b>LOCOMOTION SCORE</b> <b>2</b></p> <p>Clinical Description</p> <p><b>MILDLY LAME</b></p> <p>Description: Stands with flat back, but arches when walks. Gait is slightly abnormal.</p>	 <p>Back Posture Standing: Flat</p>	 <p>Back Posture Walking: Arched</p>
<p><b>LOCOMOTION SCORE</b> <b>3</b></p> <p>Clinical Description</p> <p><b>MODERATELY LAME</b></p> <p>Description: Stands and walks with an arched back. Short strides with one or more legs.</p>	 <p>Back Posture Standing: Arched</p>	 <p>Back Posture Walking: Arched</p>
<p><b>LOCOMOTION SCORE</b> <b>4</b></p> <p>Clinical Description</p> <p><b>LAME</b></p> <p>Description: Arched back standing and walking. Favouring one or more limbs but can still bear some weight on them.</p>	 <p>Back Posture Standing: Arched</p>	 <p>Back Posture Walking: Arched</p>
<p><b>LOCOMOTION SCORE</b> <b>5</b></p> <p>Clinical Description</p> <p><b>SEVERELY LAME</b></p> <p>Description: Arched back, refuses to bear weight on one limb. May refuse or have great difficulty moving from lying position.</p>	 <p>Back Posture Standing: Arched</p>	 <p>Back Posture Walking: Arched</p>

Figure 3-13 Recommended system for routine farm use. (Courtesy of ZINPRO Corporation)

## INCIDENCE OF LAMENESS

The incidence of lameness in dairy herds probably ranges from 0 to 60%. An annual incidence of over 10% should be regarded as a problem herd and foot health should be monitored very closely. If the incidence of sole ulcer (pp. 84–89), toe ulcer (pp. 96–99), and white line disease (pp. 89–96) together exceeds 5–10% in a herd, this would be a strong indication that subclinical laminitis (pp. 40–52) is present and a comprehensive investigation is justifiable on economic grounds.

## SCORING THE SEVERITY OF LAMENESS

The severity and duration of a lameness should be recorded in the health records of any herd with a claw health problem. A new case of lameness is one that has occurred more than 28 days after recovery from a previous incident of lameness.

### TECHNICAL COMMENT

The following modification of the lameness scoring system shown in Figure 3-13 is recommended for research studies:

- 1.0 Minimal abduction/adduction, no unevenness of gait, no tenderness
- 1.5 Slight abduction/adduction, no unevenness or tenderness
- 2.0 Abduction/adduction present, uneven gait, perhaps tender
- 2.5 Abduction/adduction present, uneven gait, tenderness of feet
- 3.0 Slight lameness, not affecting behavior
- 3.5 Obvious lameness, difficulty in turning, not affecting behavior
- 4.0 Obvious lameness, difficulty in turning, behavior affected
- 4.5 Some difficulty in rising, difficulty in walking, behavior affected
- 5.0 Extreme difficulty in rising, difficulty walking, behavior affected.

## BIBLIOGRAPHY

- Cook N 2003 Prevalence of lameness among dairy cattle in Wisconsin as a function of housing type and stall surface. *Journal of the Veterinary Medical Association* 223:1324–1328
- Hirst W M, Murray R D, Ward W R et al 2002 Generalised additive models and hierarchical logistic regression of lameness in dairy cows. *Preventive Veterinary Medicine* 55:37–46
- Sprecher D J, Hostetler D E, Kaneene J B 1997 Lameness scoring systems that use posture and gait to predict dairy cattle reproductive performance. *Theriogenology* 47:1179–1187
- Manson F J, Leaver J D 1988 The influence of concentrate amount on locomotion and clinical lameness in dairy cattle. *Animal Production* 47:185–190
- O'Callaghan K A, Cripps P J, Downham D Y et al 2003 Subjective and objective assessment of pain due to lameness in dairy cattle. *Animal Welfare* 12:605–610
- Telezhenko E, Bergsten C 2005 Influence of floor type of the locomotion of dairy cows. *Applied Animal Behavioral Science* 93:183–197
- Winckler C, Willen S 2001 The reliability and repeatability of a lameness scoring system for use as an indicator of welfare in dairy cattle. *Acta Agriculturae Scandinavica Section A Animal Science Supplementum* 30:103–107

# The Laminitis Syndrome

### KEY CONCEPT

- Laminitis in cattle is a systemic disease with local manifestation in the claws and occurs in several clinically recognizable forms. The 'acute' or 'subacute' and 'chronic' forms are similar to the condition observed in horses. A 'subclinical' form has also been described in cattle.

### HISTORICAL COMMENT

Laminitis in horses was known 2,000 years ago when it was described as 'a down-flow of blood into the animal's feet giving rise to bruises which, if not treated, take a long time to heal if the lesions suppurate.' An early description of laminitis in horses was given by Solleysel in 1691. Bedel was the first, in 1839, to describe laminitis in cattle. Lafore (1843) and Anker (1854) considered the condition to be common in cattle.

The first comprehensive and systematic clinical and morphological investigation of bovine laminitis was undertaken by Nilson in 1963. Nilson's findings and description influence our understanding of laminitis up to the present day. Only the acute, subacute, and chronic (founder) forms of laminitis were recognized until 1976, when Toussaint-Raven presented the first photograph of the alleged 'subclinical' form of the disorder.

## GLOSSARY

**Syndrome:** A number of clinical findings that are grouped under one term.

**Dermis of the claw:** Also referred to in the literature as the corium, the quick, or the pododerm (the dermis of the foot).

**Founder / foundered:** These are used commonly to describe laminitis. In this text, this term will be restricted to the chronic forms of the disorder in which obvious distortion of the claw has taken place.

## INTRODUCTION

In recent years, scientists have shown that the word 'laminitis' is an inappropriate descriptor for the disorder. They argue that the laminae are not always the only and not necessarily the first structures in the claw that are involved. Inflammation is not an invariable finding in the early stages of the disorder.

## ACUTE LAMINITIS

### Description

#### TECHNICAL COMMENT

Acute laminitis is the only form of the disease that has been induced experimentally.

In practice, acute laminitis is a rare disorder in cattle associated with accidental consumption of cereals and is one of the clinical outcomes of 'grain overload.' Affected animals rapidly become distressed. The rate of breathing is accelerated, the heart rate rises, and the feces will be liquid and lighter in color than normal. Palpation of the rumen will reveal sluggish movements or complete inactivity. The severity of the clinical signs depends on the amount of grain consumed, but most animals stagger and some will be recumbent. Crawling on the knees (Fig. 4-1), crossing legs, and engorgement

of the superficial veins of the limbs (Fig. 4-2) are other symptoms that may be observed. The stance most typical is that of camping the limbs forward and/or backward (Fig. 4-3).



**Figure 4-1** Acute laminitis occurs in feedlot cattle. Kneeling or attempting to walk on the knees is sometimes seen in feedlot cattle and in dairy cows. (Courtesy of E D Janzen)



**Figure 4-2** The large subcutaneous veins of the hindlimb may be engorged in cattle with acute laminitis. The claws may feel warmer than normal and the digital pulse may be distinct.



Figure 4-3 A cow with acute laminitis will bring its feet under its body and arch its back. (Courtesy of K Mortensen)

### Cause

Grain overload, as the name implies, involves the accidental intake of a considerable amount of cereals. The change in the environment of the rumen is both rapid and extreme. The natural buffering capacity of the rumen is overwhelmed and the rumen pH falls to 5 or below. At this point, rumen movement will cease altogether and rumenitis may supervene.

### Treatment

A case of grain overload must be treated as an emergency. Usually, more than one animal will be affected; therefore, the clinical severity of each case will be an indicator of how much grain has been consumed. In the most severe cases, rumen lavage should be practiced. A well-lubricated large bore pipe ( $\approx 1$ in in diameter) is passed down to the rumen and water from a hose is flushed into the rumen and allowed to drain out. A mild laxative, together with an antacid, should be administered by mouth.

Treatment administered within 24 hours will be the most successful. Delaying treatment beyond 48 hours may have serious consequences. Antihistaminics have a valuable role but only if given very early in treatment. The use of corticosteroids beyond 24 hours from the onset of the condition is dangerous. The administration of NSAIDs is recommended. During the recovery phase, methionine may be given at the rate of 10g/day for 3 days followed by 5g/day for 10 days. If during recovery the animal is reluctant to eat, a rumen transplant (rumen contents from the slaughterhouse) may be given as a drench.

## SUBACUTE LAMINITIS

### Description

This is a vague, ephemeral disorder that is observed coincidentally among cows known to have the subclinical form of the disorder. In other words, it is possible, in some cases, that the subacute form may precede the subclinical form. Traditionally the definition 'subacute' has been applied to animals obviously lame and showing slight clinical signs that are otherwise compatible with acute laminitis. In the light of present knowledge a better definition might be: 'A short-term laminitis-like event from which the affected animal apparently recovers.'

The defining feature of this disorder is that it is of short duration and that it causes, at least, mild discomfort such as shifting from foot to foot. Very subtle changes in gait may be observed, such as the animal placing its feet on the ground very carefully. Some refer to this gait as 'walking on egg shells.' If a cow experiences discomfort, it does so equally on all feet, thus making lameness difficult to evaluate.

One form of subacute laminitis is referred to as 'puffy foot' (Fig. 4-4). As the name implies, the skin above the coronary band and around the dew claws is swollen and pink in color. Puffy foot is most important as an indicator that the producer may be mismanaging the increase in feed intake after calving. Usually, this condition disappears spontaneously.

Another form may be associated with slight lameness which may or may not be observed shortly following a



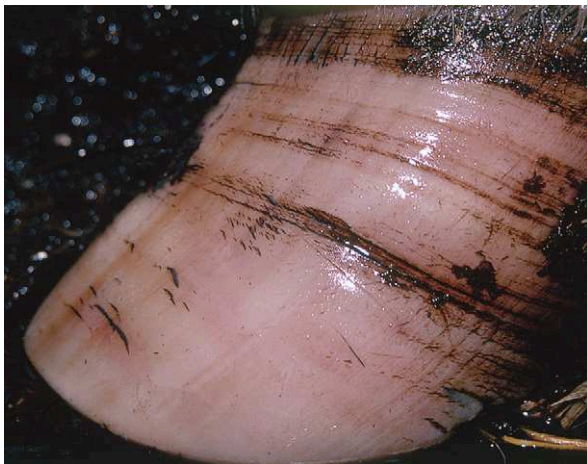
Figure 4-4 A puffy foot usually indicates that a cow is in the phase of adjusting to an increase in carbohydrate intake after calving. The sign should disappear after two or three days. If it takes longer to disappear, or if every recently calved cow has a puffy foot, there is a problem with the rate of daily increase of energy.

known insult. However, a groove in the wall of the claw running more or less parallel to the skin/horn junction emerges from beneath the coronary band some weeks after the known insult. The depth of the groove will reflect the severity or amplitude of the insult (Fig. 4-5). If the amplitude is exceptionally severe, a 'fissure' will result (Figs 4-6 and 4-7). A fissure is a crack that penetrates the entire wall. Severe cracks could also occur following acute laminitis in animals that survive, but there are no reports that this actually takes place. As a fissure grows out the toe partially breaks away forming a cap or 'thimble' (for more information see p. 235). If the insult had 'persisted' for several days, the groove will become relatively wide. This will be a weak point around which the wall will bend or buckle.

Grooves should not be interpreted as a sign that subclinical laminitis is present in the animal as they occur with a time delay following an event that has terminated.

#### TECHNICAL COMMENT

Pathologists use the words acute, subacute, and chronic to describe different stages of an inflammation. So technically these words relate to the duration of an inflammation rather than the severity.



**Figure 4-5** The simplest groove is often referred to as a 'hardship groove.' A groove such as this might form as the result of a sudden change in diet or a febrile disease such as metritis.



**Figure 4-6** On the other hand, a groove may be very deep (a fissure) which would indicate the presence of a very intense short-term stressor. The more distinct the groove, the more likely it will be for the dorsal wall to bend or 'buckle' around the groove when it grows out to the middle of the claw wall.



**Figure 4-7** The mark furthest from the skin/horn junction represents the time at which the animal calved. The groove closest to the skin/horn junction was caused by a sudden change in diet.

#### The Cause of Subacute Laminitis

There seems to be a connection between this disorder and any sudden, dramatic, but short-term change in nutrition. There is sudden release of a vasoactive agent, no doubt causing digital blood vessels to dilate and produce an increase in the pressure inside the feet, causing discomfort. Such a mechanism could also account for puffy feet. There is a distinct difference in the susceptibility between animals. When a group is subjected to a nutritional change of this nature, some may react while others may not.

## Treatment

Subacute laminitis, by definition, is a transitory occurrence that warrants recording but does not merit treatment. In the case of the appearance of a groove, the same applies. The factors causing pathophysiological disturbances believed to be associated with this condition are present some weeks before clinical signs are evident.

### SUBCLINICAL LAMINITIS (SCL) (PODODERMATITIS ASEPTICA DIFFUSA, PAD)

#### GLOSSARY

**SCL:** will be used throughout this text. However, an alternate term, 'claw horn disruption' (CHD), has been introduced by researchers seeking a more accurate descriptor for the disorder. CHD refers to a lesion rather than its pathogenesis.

## Introduction

#### KEY CONCEPTS

- A variety of lesions are now accepted as being 'laminitis-associated.' SCL causes significant weakening of the horn capsule. The result is an increased susceptibility of the claw to damage and lesions – the most important of these are white line disease and sole ulcer.
- There is increasing evidence that toe ulcers are also associated with a laminitis-like event. There is a strong probability that some cases of double sole have a laminitis component to their etiology. Heel erosion may more readily affect animals that have had subclinical laminitis.
- It is of prime importance that the reader be quite clear that the 'multifactorial concept' of etiology is the key to understanding the basis for successful preventive measures.

## Description

As the term 'subclinical' implies, there are no clinical (diagnostic) signs of this disorder during the early phase when pathophysiological changes are taking place. The condition is only known to have been present at all because SCL is associated with the high prevalence of certain specific lesions. These lesions result from two distinctly different pathological processes:

- *The structural and functional integrity of the claw horn is weakened.* The claw capsule becomes more susceptible to destruction by environmental agents. The biomechanical strength of the capsule is reduced, making it less able to sustain loading.
- *The structural and functional integrity of the suspensory apparatus of the digit and the support system of the pedal bone are weakened.*

SCL is particularly prevalent in intensively managed, high-production dairy cows during early lactation. SCL also occurs commonly among feedlot cattle. There is some evidence that 'grass founder' occurs in pasture-managed cattle following changes from poor feed to lush pastures or where concentrate supplements are offered. SCL has also been reported in intensively fed young beef bulls.

There is a strong body of evidence suggesting that hemorrhages in the sole confirm that SCL exists in the majority of the cattle in any particular group. However, experts dealing with lameness on a daily basis are of the opinion that it is not possible to distinguish a sole hemorrhage caused by SCL from one that is the result of traumatic bruising. When hemorrhages are found in the soles of the claws of a group of animals, the circumstances of management (e.g. flooring) must be taken into consideration when making a diagnosis.

#### TECHNICAL COMMENTS

Compression of the dermis, and in more severe cases disruption of vessels, occurs when traumatic external compressive forces are transferred through the capsule to the enclosed living tissue. The result is a hemorrhage. In SCL the traumatic injury of vascular structures is caused by displacement of the pedal bone (sinking). That is to say the compression causes internal damage. It does not matter whether the blood vessels are damaged by forces from outside or inside; compression is compression. When the vascular wall is disrupted, blood will ooze into the surrounding



tissue and become entrapped in the newly produced horn. In the absence of oxygen the red coloration will remain until the hemorrhage is observed weeks later on the surface of horn or during trimming of the sole.

If any of the following apply, the role of trauma will overshadow the role of SCL:

- Walking significant distances on roads (Figs 4-8, 4-9, 4-10).
- For the first 6 months after claws are exposed to new concrete.
- 1–3 weeks after cattle have been suddenly moved from a soft surface to concrete.
- When claws have been neglected and there is a great deal of overloading of the sole, the surface of which is in serious imbalance (Fig. 4-11).

SCL causes the horn of the claw capsule to become softer over several weeks. Therefore, the appearance of lesions does not occur until some time after the disorder was first affecting the animal. Eventually, a soft, worn, flat sole will become subjected to damage when the animal walks on hard surfaces. Further softening of the claw will occur if the feet are continuously exposed to slurry. Having taken due consideration of all of the foregoing exceptions and qualifications, any group of animals with a high prevalence of sole hemorrhage must be suspected of suffering from SCL.

Whether or not bleeding into the sole horn takes place as part of the pathophysiology of SCL has not been proven conclusively. Nevertheless, hemorrhage will occur automatically if the pedal bone sinks so far that pressure damages vessel walls. Trauma from overloading the claw must be accepted as part of the etiology. Figures 4-12–4-15 provide circumstantial evidence that this can be the case.

### TECHNICAL COMMENTS

'Scoring' hemorrhages may prove useful in sorting out which group of animals in a herd is most seriously being subjected to an 'insult' irrespective of whether it is caused by trauma or SCL. The severity of hemorrhages is evaluated on a scale of 1–5, 5 being the most severe. If the cumulative score for all eight claws exceeds 5 in 25% of the animals in a group, it would be appropriate to search for a risk factor that is common to that group but not to the others.

Yellow discoloration of the sole has also been proposed as a clinical sign of SCL. However, it must be remembered that superficial layers of the sole are frequently stained by slurry. Therefore, a thin layer (1–2mm) of horn must be removed before a 'true' yellow discoloration can be confirmed.

See Figures 4-16–4-18.



**Figure 4-8** These claws have been subject to wear and trauma. Note the dark hemorrhage over the typical place (flexor process of the pedal bone) in the left claw. In the same claw, the apex of the sole is worn so much that tissue beneath has been exposed. (Courtesy of J Malmo)



**Figure 4-9** These are very bruised soles. (Courtesy of J Malmo)



Figure 4-10 Probably in these claws most of the discoloration is caused by trauma. However, the appearance could be confused with that caused by SCL if the history of the animal did not include a traumatic factor. (Courtesy of J Malmo)



Figure 4-12 This is the appearance of the claws of a heifer 4 months before she calved. The color of the sole is white and the heel bulbs are unblemished.



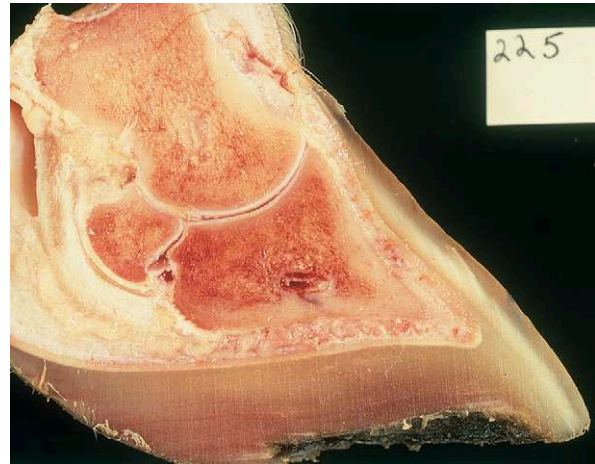
Figure 4-11 The hemorrhage seen in these claws is slight and affects areas that are not normally under load. This appearance is more typical of subclinical laminitis than of bruising. (Courtesy of C Bergsten)



Figure 4-13 This is the appearance of the claws of the same heifer as in Figure 4-11. The photograph was taken 2 months before she calved. The claw on the right has a distinctly pink tinge. The horn of the heel bulb is starting to disintegrate.



**Figure 4-14** The same heifer as in the previous two pictures. A suspicious hemorrhage is present over the typical place (over the flexor process of the pedal bone). Disintegration of the heel bulbs is now advanced. The appearance of the white line in this and the last photograph has changed from that in the first. There was no environmental or traumatic factor involved in these changes. However, the diet of this animal and others in the group was 'intensive.' These lesions seen in the feet of this heifer were typical of all of the animals in the group.



**Figure 4-15** This is a cross-section of the claw of a steer started on high-energy feed at 11 months of age and slaughtered 3 months later. At the end of 3 months, it can be seen that the layer of blood-stained sole horn formed at the level of the dermis has 'migrated' close to the surface. This supports the suggestion that hemorrhages caused by SCL appear on the surface of the claw some weeks following an insult. In this case, it can be seen that the horn closest to the dermis is normal in appearance which may be attributed to the animal adjusting to the very high level of concentrate being fed. It should also be noted that this claw grew at a rate 2.5× faster than normal. This is a typical finding among young animals on a rich diet. The thickened sole horn causes the animal to walk abnormally, possibly with a clicking sound. When this occurs in heavily fed young beef bulls, it is sometimes given as a reason for culling the animal for unsoundness which may not be the case.



**Figure 4-16** Successive insults can give a section of the sole an appearance of layers of hemorrhage and suggest that SCL can be an episodic disorder. Each layer of blood-stained horn can be seen to terminate in a groove at the heel. The grooves give the typical appearance of heel horn erosion.



**Figure 4-17** This photograph was shown at the 1st Symposium on Abnormal Foot Condition in Ruminants (Utrecht, 1976) by Egbert Toussaint-Raven. This was the first occasion on which the concept of subclinical laminitis was publicized: 'Yellow discoloration of the horn and extensive hemorrhage in the sole and the region of the white line especially in the lateral claw.' (Courtesy of E Toussaint-Raven)



**Figure 4-18** A very similar picture to Figure 4-17, but in this case the hemorrhage in the white line is very pronounced. (Courtesy of C Bergsten)

## The Cause of Subclinical Laminitis

### KEY CONCEPTS

- One common denominator associated with SCL is subacute rumen acidosis (SARA). The amount of acid produced in the rumen (amplitude) and the length of time over which abnormal levels of rumen acidosis persist (persistence) are the principal variables determining the outcome.
- A second common denominator is trauma caused by 'overloading the sole.'

## Etiology and Pathogenesis of Metabolic Laminitis: A Review of Facts and Hypotheses

### Facts

It has been proven beyond reasonable doubt that two pathological processes are consistently observed in the dermal/epidermal interface of the claws of cattle known to have had laminitis:

- Microfibrils will disappear from the collagen fibers thus weakening the bundle connecting bone and capsule. Collagen fibers are not elastic at all but microrupture in bundles of collagen weakens the suspensory apparatus and allows the bone to sink.
- Interference with horn production (keratogenesis).

These two pathologies are the endpoint of a cascade of pathophysiological events that precede the clinical manifestations of the disorder. Hypotheses have been elaborated to explain the pathogenesis of the two pathologies, which probably have common etiological components.

### Hypotheses

#### Subacute Rumen Acidosis

Metabolic problems such as SARA and ketosis are associated with subclinical laminitis. Other risk factors will either make the animal more sensitive to the effects of SARA or cause the effects of SARA to become more profound.

It has not been proposed that acidemia or a disturbance in the acid-base balance has a direct effect on the dermis of the claw. However, it has been demonstrated in human research that lactate has direct effects on the vascular endothelium, including increased permeability

and leakage. However, it is more probable that SARA has an indirect effect, either by causing endotoxins to be released from Gram-negative organisms in the rumen or by stimulating the release of biogenic messengers from the wall of the rumen. Rumenitis has been recorded as occurring concurrently with SARA.

### TECHNICAL COMMENTS

#### Bioactive Messengers

The simplest bioactive messengers, many of which have vasoactive properties, are the monoamines, which include histidine, histamine, and serotonin. Some catecholamines also have vasoactive properties; this group includes dopamine, norepinephrine, and epinephrine. Bradykinins are vasodilators; endothelin is a vasoconstrictor. Many tissues produce prostaglandins. Only a few of these have been studied in the context of SCL.

Histamine is released by neuropeptides which are produced at nerve terminations and by mast cells in response to tissue injury and inflammation of *any* tissue. Elevated histamine levels are found in the blood of cattle with acute laminitis. Histamine is very unstable in the rumen. Therefore, it is probably appropriate to conclude that histamine production associated with laminitis takes place outside of the contents of the rumen. Animals with acute laminitis respond to antihistamine therapy if administered in the early stages of the disorder. Histamine is a powerful vasodilator and acts by causing the smooth muscle in vessel walls to relax. This reaction can be reproduced experimentally by administering histamine. There is no experimental evidence that histamine release plays a major role in the etiology of SCL. (See Fig. 4-19.)

Cytokines, interleukin, and TNF alpha may be the link between SARA and tissue damage in the claw. Some of them are proinflammatory agents inducing or controlling the inflammation seen in some cases of acute and chronic laminitis. They activate matrix metalloproteinases (MMPs).

#### Endotoxins

Evidence of a direct relationship between laminitis and endotoxins in cattle is lacking. Nevertheless, endotoxin release has received considerable attention. It is a tempting hypothesis to propose that endotoxins trigger the release of biogenic agents that produce pathologic changes at the basement membrane level of the epidermis of the claw.



**Figure 4-19** This picture shows normal rumen mucosa (top left) compared with other specimens that have rumenitis in various degrees of severity. One of the inflammatory reactions arising from rumenitis is the release of histamine. (Courtesy of R Shaver)

It has also been postulated that endotoxins could be vasoactive and have a direct action on the dermis of the claw. The link between endotoxins and the alterations in the vascular system and the claw tissues has not yet been demonstrated convincingly. Recent data suggest that endotoxins trigger the production and release of cytokines in the liver and locally in tissue. Cytokines such as TNF alpha activate local cascades of inflammation or enzyme activity. This chain of events is responsible for activating MMPs or other local regulatory/modulating factors. MMP activation is also possible without inflammation. In these instances the result is non-inflammatory degradation/degeneration of the tissue and sinking of the pedal bone. Secondary tissue disruption may lead to aseptic inflammation. It must be stressed that laminitis is not as simple as SARA = laminitis, the problem is much more complex.

Endotoxins are the lipopolysaccharide component of the cell wall of Gram-negative bacteria. Acidosis causes an increased turnover of Gram-negative bacteria with subsequent release of endotoxin. Different Gram-negative bacterial strains have different side chains. The side chain known as 'the O-specific side chain' is used for serological typing of Gram-negative bacteria. No specific organism(s) has been incriminated as a mediator of SCL. However, it must be noted that *Fusobacterium necrophorum* (biotypes A and B) is the primary etiologic agent of liver abscesses. *E. necrophorum* is ubiquitous, has a proclivity for digital tissues, and has a powerful endotoxin.

The following observations have been reported in the literature:

- It is generally believed that endotoxins are not contaminants of systemic blood in healthy individuals and that their presence in peripheral blood is an indication of an impaired liver func-

tion or damage to the gastrointestinal wall barrier. There is a tendency for higher-yielding cows to have increased ruminal endotoxin levels immediately after calving.

- Cows not previously adapted to grain (or following grain overload) show an increase in concentration of free endotoxins in the rumen. From this observation, it can be concluded that endotoxins can be shed as a process of microbial growth as well as Gram-negative bacterial lysis and that a low ruminal pH may be necessary for this to occur.
- Tissue damage to the mucosa of the rumen accompanying low rumen pH is thought to increase the uptake of endotoxins.
- The rumen endotoxin concentration is related to the total number of Gram-negative bacteria in the rumen contents. The number of Gram-negative bacteria relative to Gram-positive bacteria is greater in hay-fed cattle than in grain-fed cattle. However, it is believed that the total number of bacteria is greater in grain-fed cattle. Thus the total number of Gram-negative bacteria would be greater in grain-fed cattle compared to hay-fed cattle. Feeding grain has been shown to favor the growth of acid resistant *Escherichia coli* spp.
- A gradual increase in ruminal endotoxin has been found to match the increase in the level of concentrate in the diet.
- Calves affected with bovine virus diarrhea have been observed to have laminitis when they were 8–12 weeks of age. At this age, it is doubtful that the rumen was fully developed, although these animals were fed a rich carbohydrate diet. While a virus may not be directly implicated in the pathogenesis of SCL, it may cause an inflammatory reaction in the gut, making it vulnerable to invasion by Gram-negative organisms.
- Damage to the walls of the tiny vessels (endotoxins plus the presence of bradykinin-like substances) allows red blood cells and fluid to escape without rupturing them (diapedesis) and causes an increase in interstitial pressure.
- Damage to the vessel walls causes blood clots to form (mural thrombosis) which will reduce the supply of blood to the dermis (localized ischemia), thereby depriving surrounding tissues of oxygen and nutrients and ultimately causing tissue death (necrosis).
- Following tissue damage and death, new blood vessels are created and invade the affected area, bringing white cells to the region and initiating scar tissue formation.
- As the intra-ungular pressure increases, the capillary flow decreases, pain is intensified, and the capillaries, arterioles, and arteriovenous shunts dilate to a maximum. The leakage of fluid and blood from the microcirculation occurs. Stagnation of blood within the capsule accelerates mural thrombus formation. It has been found that capillary pressures and post-capillary resistance are significantly higher in grain overload steers compared with control animals. No such difference is observed in the horse. It has been suggested that this accounts for the different clinical presentation seen in the two species.

It is not clear how, and/or at what stage, inflammatory components contribute to degenerative events or even whether they are necessarily involved at all.

There is some evidence that young cattle can recover from this phase of laminitis and that recurrence of the disorder can occur at a later date. The development of collateral circulation could explain some instances of recovery from an episode of SCL. Clinical experience suggests that an animal that has had subclinical laminitis once will be more susceptible to subsequent laminitis-like episodes. Repeated episodes of laminitis cause chronic vascular damage (arteriosclerosis) which could account for the etiology of chronic laminitis.

### Changes in the Microcirculation

Vasoactive agents released into the blood stream cause responses in the microvasculature of the dermis, i.e., dilation, constriction, or leakage. The degree of response depends on the quantity of agent released and the period over which vulnerable tissues are exposed. The following are among the most likely reactions:

- Dilation of arterioles causes blood flow to slow. Reduced drainage of blood on the venous side in combination with endothelial damage and leakage leads to increased transvascular movement and subsequent pressure increase in the capsule.
- Opening of arteriovenous shunts diverts blood into deeper parts of the vascular bed, thereby contributing to blood stagnation in the dermis and causing local ischemia.

### Changes in the Quality of the Horn of the Claw

The horn-producing (keratogenic) epidermal cells (living epidermis) are supplied with nutrients from the blood vessels in the underlying dermis (corium). If the blood supply is reduced, interference with horn production will follow. However, the pathological outcome (as well as the clinical outcome seen in the wall of the claw) differs from that seen in the sole. The reason for this is that the number of keratogenic cells, as well as their proliferative

and synthetic activity, differs in the following three anatomic regions of the claw:

- A. The coronary epidermis produces the horn of the wall (coronary epidermis). The rate of horn production on the dorsal surface of the claw is  $5 \pm 2$  mm/month. The highest rate of horn production in the region of the abaxial groove (8 mm/month and more). Therefore, if the rate of horn production is correlated to the surface area of the underlying dermis the highest relative growth activity is in the abaxial end of the white line.
  - Temporary cessation of horn production will result in a groove or fissure.
  - Short-term increase in horn production occurs occasionally, resulting in the production of a ridge around the surface of the wall.
  - Intermittent spurts of horn production appear to be responsible for a rasp-like appearance of the surface of the claw wall.
- B. The epidermis of the sole has the next most active keratogenic tissues and normally produces horn at about one-third of the rate of wall growth. Production of sole horn of poor quality is the best documented outcome of compromised blood perfusion and contributes to conditions such as white line disease and sole ulcer. Cessation of sole-horn production does occur and is seen clinically as 'double sole.'
- C. The epidermal lamellae form the region least well supplied with keratogenic tissues. This means that very little horn is produced in this region and that the lamellae increase only slightly in depth as they move distally.

Changes in epidermal cell ultrastructure occur in advance of any detectable clinical signs of laminitis. For this reason, it has been impossible to study the histopathological changes occurring in the bovine claw immediately following the insults causing SCL in commercial herds. Much of the information has been obtained from experimental studies of claw tissues from animals with acute laminitis induced by grain overload or following experimental injections of endotoxin. Other information has been gathered from chronic cases of laminitis.

### Other Biogenic Agents Active at the Dermal/Epidermal Interface

#### **Matrix Metalloproteinases (MMPs)**

These are one of many agents responsible for the continuous process of tissue replacement throughout the body. In this case, they degrade old collagen fibers which are replaced by newly synthesized fibers. This turnover

maintains the structural integrity of collagen systems, including the fibrous network which makes up the suspensory apparatus of the digit and support system of the pedal bone (see p. 20). Increased MMP activity results from increased conversion of the inactive pro form into the active form, while at the same time inhibitors are down-regulated.

Activation is triggered by endotoxins, a number of cytokines, and hypoxia. Pathological activity of MMPs leads to increased collagen degradation and loosening and elongation of the collagen fibers of the suspensory apparatus of the digit and support system of the pedal bone. This accounts for displacement of the pedal bone as well as the occurrence of toe ulcers. Deterioration of the structural integrity in hooves of heifers around calving compared with maiden heifers has been clearly demonstrated. The deterioration progressed from 2 weeks pre-calving to 12 weeks post-calving. At the same time, a highly significant increase in MMP-2 in calving heifers was found as well as a highly significant correlation between MMP-2 and 'hoofase,' a novel gelatinolytic protease of 52kD. The hooves of one cow diagnosed with laminitis expressed high levels of hoofase.

#### **Epidermal Growth Factor (EGF)**

This is known to be produced when the gut wall is damaged, as is the case of the rumen wall during an episode of SARA. Receptors for EGF have been found in the basement membrane of the epidermis of the claw.

### Mechanical Risk Factors

#### **Overloading the Sole of the Claw**

There is an interaction between the tissue damage caused by metabolic disturbance and overloading on hard flooring – both factors together result in the lesions seen in SCL. It is essential for the reader to appreciate that two factors, trauma and metabolic disturbance, have to be taken into consideration when addressing herd management. Managing how the cows are changed from one flooring system to another is exceptionally important.

Some workers have stated that the interaction of the sole of the claw with a concrete surface is a risk factor almost as important as nutritional mismanagement. To support their argument, it has been found that the incidence of SCL is lower when the animals are confined in yards or corrals with soft bedding, or tied in stalls with rubber mats (p. 80). It is hypothesized that when the sole of a claw is 'overloaded' the dermis suffers damage and local biogenic agents are released. On hard floors, the alterations in the tissue inside the claw are much more dramatic than soft floors.

### **Exercise and Movement**

The ability and willingness of dairy cows to lie down are now considered to be an important risk factor. The standing/lying behavior of intensively managed dairy cattle influences the rate of blood diffusion through the dermis of the claw. During inactive standing, there will be poor oxygenation and toxin removal (p. 72).

### **Stress**

There is now strong evidence that stress caused by the cow's living condition (metabolic stress) also is a risk factor to be considered. The environmental risk factors (stressors) worsen as management systems intensify.

Very little is known about how stress affects cattle. Does the brain and central nervous system react to social confrontation, overcrowding, or noise toleration? Many scientists are reluctant to attribute emotional feelings to such a phlegmatic beast as a cow. Nevertheless, there is an increasing awareness that bovine behavior is dictated by fear of discomfort or the dominance of other cows. Cows will voluntarily choose not to seek resources if they have learned that it is uncomfortable to do so. It is not known if this type of stress is powerful enough to generate the release of cortisol or substance P in sufficient quantities to tip the delicate balance in the basic metabolism of the cow. Cows exposed to common stressors have not only a higher incidence of lameness than normal, but the incidence of reproductive disorders and other diseases increases also.

### **Endocrine Control**

Several researchers have proposed that disorders causing lameness are under endocrine control. Considerable support for this argument stems from the observation that laminitis-like lesions seem to have a common focal point, the peri-partum period. Until recently, it has been assumed that the increase of laminitis-like lesions around calving is due exclusively to changes in nutrition and management. However, there is a surge in the level of hormones in the blood associated with parturition. Relaxin is one of several hormones that might influence the pathophysiology of SCL. Also unknown is the possible influence that growth hormones could have. Thirty years ago, many heifers calved for the first time when they were 36 months of age. Today, there is ever increasing pressure to deliver the first calf before a heifer is 24 months of age. At this age, growth hormone activity must still be much higher than it would be in mature cows.

### **Summary**

The foregoing review demonstrates that the cause of subclinical lameness is still very unclear. Particularly the links between metabolic/systemic problems and the local events in the claw tissue. The multitude of potential biogenic agents could include others yet to be identified and/or studied. There may be several permutations by which bioactive molecules and risk factors work together to produce the several different clinical manifestations of the disorder.

### **Changes Occurring Inside the Claw**

Horn production is disturbed over a prolonged period, causing the sole to become considerably softer than normal because there is a decrease in cell adhesion due to changes in the intercellular cementum. Increased flexibility of sole horn is instrumental in increasing pressure over the flexor process of the pedal bone, which is part of the pathogenesis of sole ulcer which develops from inside the capsule. Poor-quality horn in the white line is the initiating process in white line disease. Probably heel erosion may be more prevalent when the horn at the heel is softer than normal. The appearance of the wall of the claw may change over time.

Displacement of the pedal bone takes place when the fibers of the suspensory apparatus of the digit are damaged. Permanent sinking is only observed in a small but significant percentage of cases of SCL, although dynamic changes with non-permanent sinking cannot be excluded. The risk factor responsible for this particular pathology has not been identified.

### **Risk Factors Impacting the Outside of the Claw Capsule**

- Hardness of the floor, traumatizing the vasculature of the claw.
- Amount of wear of the sole of the claw, making it flexible and subject to trauma.
- Softening of sole horn caused by exposure to slurry.
- Inability to move around freely, reducing blood flow through the claws.
- Unwillingness to lie down for adequate periods causing blood to pool in the claws.
- Low environmental temperature.

### **Treatment of SCL**

Treatment of individual animals affected with SCL is not practical due to the difficulties in being sure to which stage the condition may have progressed. Therefore, preventive measures at the herd level are mandatory.



## Control of SCL

The disorder has been, for many years, regarded as having a 'multifactorial' etiology. The 'risk factors' that make up the multifactorial package can be conveniently divided into five groups:

1. *Metabolic Disorders (including SARA)*: Many different combinations of nutritional risk factors can increase or decrease rumen acidosis (see Chapter 5).
2. *Trauma*: Risk factors related to hard floor surfaces (see p. 78).
3. *Cow Comfort*: Risk factors causing prolonged standing and reduced blood flow to the feet (see Chapter 6).
4. *Stress*: Risk factors causing stress can be environmental or psychological (see p. 71). Systemic diseases can also play a part.
5. *Genetic Selection*: (see Chapter 12).

Rather than repeat the appropriate information here the reader is directed to the relevant pages of this book noted above. SARA presents the widest range of variables (risk factors) which demand continuous monitoring and the greatest skill on the part of the animal attendants. The other factors are of no less importance, but each calls for long-term management decision making.

## CHRONIC LAMINITIS

### Description

This disorder is often referred to in Europe as 'slipper foot' as the affected claw is thought to resemble a Persian slipper (Fig. 4-20). Probably, it would be more descriptive to refer to this condition as 'founder.' Usually, this condition affects older cows. In dairy herds, only a small percentage of cows will be affected. There may be a heritable component to the condition, but this has never been established.

The coronary band is the first part of the capsule to show signs of deterioration. It becomes darker in color, may be rough, and/or have a fringe of fragmenting horn (Fig. 4-21).

As the condition progresses, the dorsal wall flattens and becomes concave along its length. Most of the abnormal shape is caused by the rotation and sinking of the pedal bone inside the claw that changes the growth direction. This deformation cause more pressure to be exerted on the posterior region of the sole and sole ulcer may be appear.

As the sole widens, so does the white line. The risk of foreign-body involvement increases. Frequently, the apex

of the claw breaks off, leaving a square end. Extreme ridging of the wall gives the condition its typical appearance. The sole is much wider and flatter than is normal. One or more claws may be affected, although the condition occurs more commonly in the lateral hind claw.

### Cause

It has never been proven that this condition is the result of repeated episodes of laminitis. Nevertheless, slaughterhouse specimens are abundant, and many pathological findings attributed to laminitis are based on such material. The assumption may be correct that chronic laminitis is a sequel to other forms of this disorder, but it also possible that due to the sporadic incidence it is just as likely that some cows are more susceptible to this form of laminitis than others.



Figure 4-20 This is a typical slipper foot showing a flattened concave dorsal surface.



Figure 4-21 These claws have square toes, the dorsal surface is flat and concave. The coronary band is rough and has a horny fringe.

## Treatment and Control

This disorder seems to take about 12 months to become evident, and there may be no warning that change in appearance is going to occur. Once established, no amount of claw trimming or other treatment will bring about resolution. The animal may expect about 6 months of functional life before humane slaughter becomes mandatory.

## PATHOLOGY OF LAMINITIS

### KEY CONCEPTS

- It must not be assumed (or categorically excluded) that pathological changes reported as typical of either acute or chronic laminitis are also typical of subclinical laminitis.
- Subclinical laminitis is asymptomatic and changes in claw morphology and epidermal cell structure occur in advance of any detectable signs of the disorder.

## Gross Pathology

In acute laminitis, hemorrhage and congestion dominate the picture. In some specimens displacement of the pedal bone will be observed. A groove is present in the corium around the periphery of the bone.

In chronic laminitis, displacement of the pedal bone will be observed more frequently than in acute laminitis. The claw capsule will be deformed, and old hemorrhages will be present in the horn and dermis. The horn will be softer than normal and stained yellow.

### GLOSSARY

**Displacement of the Pedal Bone:** This non-specific term is being used in the text to describe changes in the position of the pedal bone relative to the claw capsule. The terms 'rotation' and 'sinking' are in common use but still await precise pathological definition

### TECHNICAL COMMENTS

So called 'rotation' is believed to occur as the result of failure of the suspensory apparatus of the pedal bone attached to the dermal lamellae, which are most extensive on the inside the dorsal wall of the claw. A noticeable increase in the space between the apex of the pedal bone and the wall occurs (Fig. 4-22). The apex can intrude into or penetrate through (prolapse) the most anterior part of the sole, and for this reason has been linked to a toe ulcer and possibly a toe abscess (Fig. 4-23).

Although 'rotation' of the bone around its long axis is known to occur, some deviation of the transverse axis (tilt) and/or sinking also may be present and this may be associated with changes in the white line.

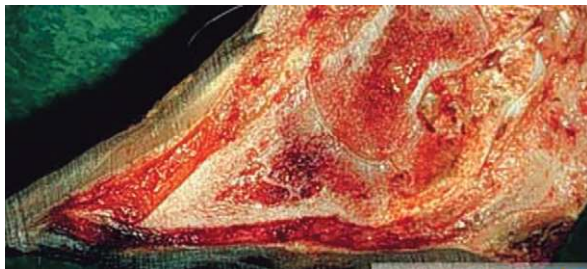
There are no lamellae on the inside of the posterior half of the wall of the claw. However, there is an extensive network of fibers encasing the digital cushion and deep flexor tendon (the retinaculum). This is referred to in this text as the support system of the pedal bone (p. 20). It is suggested here that the term 'sinking' of the pedal bone should be confined to pathological changes seen in the posterior half of the claw. It has been reported that 'heel height' decreases as a cow ages, which may or may not indicate a collapse of the structures inside of the heel. Furthermore, it has been shown that the fat content of the digital cushion changes as an animal ages. Recent studies have shown that sinkage of the pedal bone is directly associated to the development of sole ulcers, particularly if exostoses are present in the solear surface of the pedal bone. The same work has established that the collagen fibers also stretch in the posterior region of the claw; these fibers are distinct from those associated with the dermal lamellae. These findings open the possibility that the activity of MMPs could weaken all collagenous structures including the strength of the retinaculum (which binds the shock-absorbing structures in the heel). If this does happen, the flattening and lateral expansion of these structures might explain something of the etiology of white line disease.

### Necropsy Techniques

The opportunity to perform a post-mortem examination of the claws of an animal with SCL is extremely rare (unless the animal dies from some other disease). Performing a necropsy of the feet of an animal affected with acute,

subacute, and chronic laminitis provides the clinician with little information of value. Nevertheless, the ability to exhibit the pathology of laminitis may be a useful demonstration for clients:

- Traditionally, a sagittal section of a claw has been used to study the gross pathology of the digital region. This technique is useful in observing displacement of the pedal bone, double sole, and hemorrhages in the epidermis (Figs 4-22 and 4-23).
- Removal of the claw capsule (exungulation) has proven to reveal a whole new dimension to the pathology of laminitis and should be regarded as an essential procedure in the post-mortem identification of this disorder (Fig. 4-24).



**Figure 4-22** A sagittal cross section reveals displacement (sinking or rotation) of the pedal bone within the capsule. Pathology of the bone may be present. (Courtesy of C Bergsten)



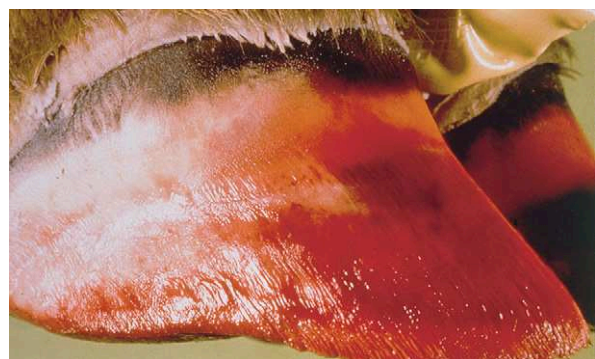
**Figure 4-23** This is the earliest stage of 'displacement of the pedal bone.' The apex of the pedal bone has caused a slight depression in the sole. A widening of the space between the wall and the dorsal surface of the bone has occurred.

## Microscopic Pathology

In acute laminitis the common indicators are: hyperemia, congestion (Fig. 4-25), edema, thrombi (Fig. 4-26), hemorrhages, and accumulations of lymphocytes, histiocytes, and fibroblasts. In the epidermis, the cells of



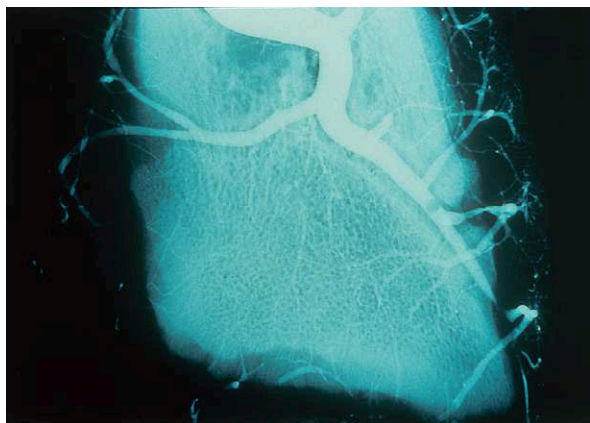
**Figure 4-24** The digital region of a cadaver is immersed in water at 60°C for 20 minutes. The capsule is fixed in a vice and the digit levered away. (Courtesy of P Ossent)



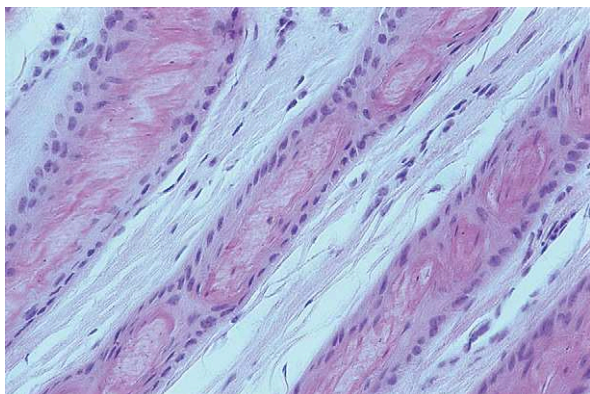
**Figure 4-25** Congestion, edema, and hemorrhage of the laminae are evidence of sinkage. Usually, it takes some time for blood to discolor the 'lamellar' region; this gives some indication of the time elapsed since the onset of pathological changes in the live animal. (Courtesy of P Ossent)

the *stratum germinativum* and *stratum spinosum* will be enlarged and disorientated, with a partial or complete disappearance of keratogenic substance. Acidophilic keratin bodies are present in the lamellae (Fig. 4-27). The lamellae are longer and thinner in their inner extremity than is normal. Detachment of the basal membrane may occur.

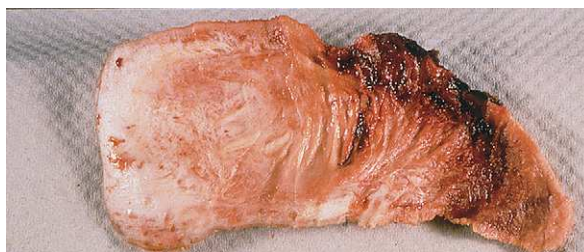
In chronic laminitis, there will be old thrombi, accumulations of mononuclear cells, chronic granulation tissue with marked proliferation of capillaries, and heavy fibrosis of the corium (Fig. 4-28). The laminae will be thicker than normal and the lamellae thinner. Arteriosclerosis and atherosclerosis are usually present.



**Figure 4-26** The presence of thrombi (blood clots) causes constrictions. These are most prevalent at the point the blood vessel exits from the distal phalanx. Localized ischemia follows, with tissue necrosis and scar deposition being the final phase of the pathology. (Courtesy of R Boosman)



**Figure 4-27** The lamellae become irregular in shape, the basal cells become picnotic, and irregular islets of horn are arranged in the substance of the leaflet.



**Figure 4-28** In the final stages of the pathology, large amounts of scar tissue are found in the dermis of the sole. (Courtesy of P Ossent)

It is probable that a disruption of keratin metabolism in the epidermis occurs in all forms of laminitis. Normal organization of keratin fibers is disrupted and irregular. A reduced proportion of cystine and methionine has been reported.

## BIBLIOGRAPHY

- Ahrens F A 1967 Histamine, lactic acid and hypertonicity as factors in the development of rumenitis in cattle. *American Journal of Veterinary Research* 28:1335-1338
- Andersson L, Bergman A 1980 Pathology of bovine laminitis especially as regards vascular lesions. *Acta Veterinaria Scandinavica* 21:559-566
- Andersen P H 1990 Aspects of bovine endotoxaemia of possible relevance to lesions in the ruminant digit. *Proceedings of the VIth International Symposium Diseases of the Ruminant Digit, Liverpool, UK* p 59-69
- Andersen P H 2000 Bovine endotoxemia: Aspects of relevance to ruminal acidosis. PhD Thesis, The Royal Veterinary and Agricultural University Copenhagen
- Andersen P H, Jarlov N 1990 Investigation of the possible role of endotoxin, TXA<sub>2</sub>, PGI<sub>2</sub> and PGE<sub>2</sub> in experimentally induced rumen acidosis in cattle. *Acta Veterinaria Scandinavica* 31:27-38
- Andersen P H, Bergelin B, Christensen K A 1994a Effect of feeding regimen on concentration of free endotoxin in ruminal fluid of cattle. *Animal Science* 72:487-491
- Andersen P H, Hesselholt M, Jarlov N 1994b Endotoxin and arachidonic acid metabolites in portal, hepatic and arterial blood of cattle with acute ruminal acidosis. *Acta Veterinaria Scandinavica* 35:223-234
- Andersen P H, Jarlov N, Hesselholt M et al 1996 Studies on in vivo endotoxin plasma disappearance times in cattle. *Journal of the American Veterinary Medical Association* 43:93-101
- Bargai U, Shamir A, Lubin A et al 1992 Winter outbreaks of laminitis in calves: aetiology and laboratory, radiological and pathological findings. *Veterinary Record*, 131:411-414
- Bargai U 1998 Risk factors for subclinical laminitis (SL): a study of 32 kibbutz herds in Israel. *Israeli Journal of Veterinary Medicine* 53:80-82

- Bargai U, Levin D 1993 Sub clinical laminitis in dairy cattle in Israel. *Israeli Journal of Veterinary Medicine* 48:168–172
- Bergsten C 1994 Haemorrhages of the sole horn of dairy cows as a retrospective indicator of laminitis: an epidemiological study. *Acta Veterinaria Scandinavica* 35:55–66
- Bergsten C 2001 Effects of conformation and management system on hoof and leg diseases and lameness in dairy cows. *Veterinary Clinics of North America Food Animal Practice* 17:1–23
- Bergsten C, Greenough P R, Gay J M, Seymour W M, Gay C C 2003 Effects of biotin supplementation on performance and claw lesions on a commercial dairy farm. *Journal of Dairy Science* 86:3953–3962
- Boosman R, Németh F, Gruys E et al 1989 Arteriographical and pathological changes in chronic laminitis in dairy cattle. *Veterinary Quarterly* 11:144–155
- Bradley H K, Shannon D, Neilson D R 1989. Subclinical laminitis in dairy heifers. *Veterinary Record* 125:177–179
- Christmann U, Belknap E B, Lin H C et al 2002 Evaluation of hemodynamics in the normal and laminitic bovine foot. *Proceedings of XIth International Symposium on Lameness in Ruminants*, p 165–166
- Clarkson M J, Downham D Y, Faull W B et al 1996 Incidence and prevalence of lameness in dairy cattle. *Veterinary Record* 138:563–567
- Ekfalck A, Funkquist B, Jones B et al 1988 Presence of receptors for epidermal growth factor (EGF) in the matrix of the bovine hoof – a possible new approach to the laminitis problem. *Zentralblatt Veterinaria Medicin Association* 35:321–330
- Garner M R, Flint J F, Russell J B 2002 *Allisonella histaminiformans* gen. nov., sp. nov. A novel bacterium that produces histamine, utilizes histidine as its sole energy source and could play a role in bovine and equine laminitis. *Systematic and Applied Microbiology* 25:498–506
- Garrett E F, Pereira M N, Nordlund K V et al 1999 Diagnostic methods for the detection of subacute ruminal acidosis in dairy cows. *Journal of Dairy Science* 82:1170–1178
- Goad D W, Goad C L, Nagaraja T G 1998 Ruminal microbial and fermentation changes associated with experimentally induced subacute acidosis in steers. *Journal of Animal Science* 76:234–241
- Greenough P R, Gacek Z 1986 A preliminary report on a laminitis-like condition occurring in bulls under feeding trials. *Proceedings of the Vth International Symposium on Disorders of Ruminant Digit*, Dublin, Ireland, p 63–68
- Greenough P R, Vermunt J J 1991 Evaluation of subclinical laminitis in a dairy herd and observations on associated nutritional and management factors. *Veterinary Record* 128:11–17
- Greenough P R 1991 A review of factors predisposing to lameness in cattle. In: Owen J B, Axford R F E (eds) *Breeding for Disease Resistance in Farm Animals*. Commonwealth Agricultural Bureau, p 371–393
- Greenough P R, Vermunt J J, McKinnon J J 1990 Laminitis-like changes in the claws of feedlot cattle. *Canadian Veterinary Journal* 31:202–208
- Greenough P R, Weaver A D, Broom D M 1997 Basic concepts of bovine lameness. In: Greenough P R, Weaver A D (eds) *Lameness in cattle*. W B Saunders, Philadelphia, p 10
- Hendry K A K, Knight C, Galbraith H et al 2003 Basement membrane integrity and keratinization in healthy and ulcerated bovine hoof tissue. *Journal of Dairy Research* 70:19–27
- Hendry K A K, MacCallum A J, Knight C H et al 1999 Effect of endocrine and paracrine factors on protein synthesis and cell proliferation in bovine hoof tissue culture. *Journal of Dairy Research* 66:23–33
- Hendry K A K, MacCallum A J, Knight C H et al 1997 Laminitis in the dairy cow: a cell biological approach. *Journal of Dairy Research* 64:475–486
- Hoblet K, Weiss W, Anderson D, Maeschberger M 2002 Effect of oral biotin supplementation on hoof health in Holstein heifers during gestation and early lactation. *Proceedings of the XIth Symposium on Lameness in Ruminants*, Orlando, p 253–256
- Hunt R J, Allen, D, Moore J, N 1990 Effect of endotoxin administration on equine hemodynamic and Starling forces. *American Journal of Veterinary Research* 51:1703–1707
- Johnson P J, Tyagi S C, Katwa L C et al 1998 Activation of extracellular matrix metalloproteinases in equine laminitis. *Veterinary Record* 142:392–396
- Lischer Ch J, Ossent P, Räber M et al 2002 Suspensory structures and supporting tissues of the third phalanx of cows and their relevance to the development of typical sole ulcers (Rusterholz ulcers). *Veterinary Record* 151:694–698
- Lischer Ch J, Ossent P 2002 Pathogenesis of sole lesions attributed to laminitis in cattle. *Proceedings of the XIth International Symposium on Lameness in Ruminants*, Orlando, p 82–89
- Lischer Ch J, Ossent P 2000 The significance of the suspensory mechanism of the third phalanx and its fat bodies in the pathogenesis of sole ulcers in cattle. Part I: macroscopic findings. *Proceedings of IXth International Symposium on Bovine Lameness*, Parma, p 222–225
- Maclean C W 1965 The pathological changes accompanying acute laminitis in the dairy cow. *The Veterinary Record* 77:662–672
- Maclean C W 1971 The histopathology of laminitis in dairy cows. *Journal of Comparative Pathology* 81:563–570
- Manson F J, Leaver J D 1988a The influence of dietary protein intake and of hoof trimming on lameness in dairy cattle. *Animal Production* 47:191–199
- Manson F J, Leaver J D 1988b The influence of concentrate amount on locomotion and clinical lameness in dairy cattle. *Animal Production* 47:185–190
- Mill J A, Ward W R 1993 Lameness in dairy cows and farmer's knowledge, training and awareness. *Veterinary Record* 134:162–164
- Mortensen K, Hesselholt M 1982 Laminitis in Danish dairy cattle – an epidemiological approach. *Proceedings of the IVth International Symposium on Disorders of the Ruminant Digit*, Paris, p 31–32

- Mortensen K 1986 Pathogenesis of laminitis in cattle. Proceedings of the 5th International Symposium on Disorders of the Ruminant Digit, Dublin, p 32
- Mortensen K, Hesselholt M 1986 The effects of high concentrate diet on the digital health of dairy cows. Proceedings of the International Production Congress, Belfast
- Mortensen K, Hesselholt M, Basse A 1986 Pathogenesis of bovine laminitis (diffuse aseptic pododermatitis). Experimental models. Proceedings of the XIVth World Congress on Diseases of Cattle, Dublin, p 1025–1030
- Mortensen K W 1997 Doctoral thesis. The Royal Veterinary and Agricultural College, Copenhagen
- Mungal B A, Kyaw T M, Pollitt C C 2001 In vitro evidence for a bacterial pathogenesis of equine laminitis. *Veterinary Microbiology* 79:209–223
- Nagaraja T G, Fina L R, Bartley E E, Anthony H D 1978a Endotoxic activity of cell-free rumen fluid from cattle fed hay or grain. *Canadian Journal of Microbiology* 24:1253–1261
- Nagaraja T G, Bartley E E, Fina LR 1978b Relationship of rumen Gram-negative bacteria and free endotoxin to lactic acidosis in cattle. *Journal of Animal Science* 47:1329–1337
- Nagaraja T G 2000 Liver abscesses in beef cattle: Potential for dairy monitoring. *American Association of Bovine Practitioners Proceedings* 33:65–68
- Nocek J E 1996 The link between nutrition, acidosis, laminitis and environment. *Proceedings of the Western Canadian Dairy Seminar* 8:49–68
- Nocek J E 1997 Bovine acidosis: Implications on laminitis. *Journal of Dairy Science* 80:1005–1028
- Nilsson S A 1963 Clinical, morphological and experimental studies of laminitis in cattle. *Acta Veterinaria Scandinavica [Suppl]* 4:9–304
- Nordlund K 2002 Herd-based diagnosis of subacute ruminal acidosis. Proceedings of the XIIth International Symposium on Lameness in Ruminants, Orlando, p 70–79
- Nordlund K 2001 Herd based diagnosis of subacute ruminal acidosis. Preconvention Seminar 8: Dairy Herd Problem Investigations. *American Association of Bovine Practitioners 34th Annual Convention, Vancouver*, p 4
- Nordlund K, Garrett E F, Oetzel G R 1995 Herd based rumenocentesis: a clinical approach to diagnosis of subacute rumen acidosis in dairy herds. *Compendium Continuing Education Practicing Veterinarian* 17:48–56
- Ossent P, Lischer Ch J 1998 Bovine laminitis: the lesions and their pathogenesis. *In Practice* 20:15–427
- Peterse D J, Van Vuuren A M, Ossent P 1986 The effects of daily concentrate increase on the incidence of sole lesions in cattle. Proceedings of the Vth International Symposium on Disorders of Ruminant Digit, Dublin, Ireland, p 39–46
- Peterse D J, Van Vuuren A M 1984 The influence of a slow or rapid concentrate increase on the incidence of foot lesions in freshly calved heifers. Proceedings of the European Association on Animal Production Congress, The Hague, the Netherlands
- Silva L A F, Cunha P H J, Fiorvanti M C S et al 2001 The prevalence of locomotor system diseases in cattle raised in extensive and semi-intensive production systems from different regions of Goias State. *Veterinaria Noticias* 7:93–101
- Svensson C, Bergsten C 1997 Laminitis in young dairy calves fed a high starch diet and with a history of bovine viral diarrhoea virus infection. *Veterinary Record* 140:574–577
- Takahashi K, Young B A 1981 Effects of grain overfeeding and histamine injection on physiological responses related to acute bovine laminitis. *Japanese Journal of Veterinary Science* 43:375–385
- Tarlton J F, Holah D E, Evans K M 2002 Biomechanical and histopathological changes in the support structures of bovine hooves around the time of first calving. *Veterinary Journal* 163:196–204
- Tarlton J F, Webster A J F 2002 A biochemical and biomechanical basis for the pathogenesis of claw horn lesions. Proceedings of the XIIth International Symposium on Lameness in Ruminants, Orlando, p 395–400
- Throefner M B, Pollitt C C, van Eps A W 2004 Acute bovine laminitis: A new induction model using alimentary oligofructose overload. *Journal of Dairy Science* 87:2932–2940
- Throefner, M B, Wattle O, Pollitt C C 2005. Histology of oligofructose-induced acute laminitis in heifers. *Journal of Dairy Science* 88:2774–2782
- Van de Haar M J 1998 Accelerated heifer growth: truth or consequences. Proceedings Tristate Dairy Nutrition Conference, Fort Wayne, p 158–175
- Vermunt J J 1994. Predisposing causes of laminitis. Proceedings of the VIIIth International Symposium on Disorders of the Ruminant Digit, Banff, p 236
- Vermunt J J, Greenough P R 1994. Predisposing factors of laminitis in cattle. *British Veterinary Journal* 150:151–164.
- Vermunt J J 1992 'Subclinical' laminitis in dairy cattle. *New Zealand Veterinary Journal* 40:133–138
- Ward W R 1994 The role of stockmanship in foot lameness in UK dairy cattle. Proceedings of the VIIIth International Symposium on Disorders of the Ruminant Digit, Banff, p 301–302
- Whay H R, Main D C J, Green L E 2002 Farmer perception of lameness prevalence. Proceedings of the XIIth International Symposium on Lameness in Ruminants, Orlando, p 355–358
- Westwood C T Lean I J 2001 Nutrition and lameness in pasture-fed cattle. Proceedings of the New Zealand Society of Animal Production 61:128–134

# Nutritional Risk Factors

### GLOSSARY

**Slug Feeding:** Offering a large amount of non-structural carbohydrates in one meal.

**Component Feeding:** Feeding concentrate component separate from the forage component.

**Lead Feeding (Steaming Up):** Gradually introducing cows to a high concentrate ration before they calve.

**Non-Structural Carbohydrates:** Carbohydrate derived from cereals compared to energy resulting from the fermentation of the structured components of plants.

**Transition Period:** This is the period encompassing the last 3–4 weeks of pregnancy and the first 3–4 weeks of lactation.

**pH:** The hydrogen ion concentration which evaluates alkalinity ( $> 7$ ) and acidity ( $< 7$ ).

**Push-up:** In a feed bunk system this is the practice of pushing up feed to within the reach of the cows.

## INTRODUCTION

### KEY CONCEPTS

- Errors in nutrition may not occur intentionally. However, errors do occur without the producer or nutritionist being aware of their occurrence.
- Frequently, lameness caused by nutritional error only becomes noticeable weeks or months following the error; therefore, investigating the nutritional cause of lameness must be conducted in an historic context.
- Dry-matter (DM) intake typically drops by up to 30% in the last 3–4 weeks of pregnancy.
- The target dry-matter intake (DMI) is 1.2% of the body weight for a dry cow and 3% (1% neutral detergent fiber (NDF) for an animal in milk.

## SUBACUTE RUMINAL ACIDOSIS (SARA)

### KEY CONCEPTS

- SARA is the non-physiological decrease in rumen pH. There is a consensus of opinion that the ‘threshold,’ or the pH below which SARA should be considered to exist, lies somewhere between a pH of 5.8 to 5.6 (amplitude). The other factor determining the impact of SARA is the length of time the rumen pH is below the threshold (persistence).
- SARA is the starting point of a cascade of events causing subclinical laminitis (SCL) and those diseases closely associated with SCL.
- Incidence of SARA can be minimized if rumen environment is given time to adapt.
- If subclinical laminitis is prevalent in a herd, then SARA may also be present.

Some of the most common scenarios accounting for the presence of SARA are:

- Failing to acclimatize the environment of the rumen and rumen papillae to carbohydrate intake

prior to introducing cows to their full lactation ration.

- Lack of awareness by the producer that there has been a sudden change in the components of a ration. Frequently, sudden changes in the functional effective fiber are overlooked.
- Infrequent or inconsistent feeding, reduced lying time, and poor water availability.
- Reducing dietary fiber levels during periods of heat stress.
- Excess time without access to feed including excess time in the holding pen and infrequent feed push-up.

The economic impact of SARA cannot be ignored. In one herd, it was calculated that SARA caused an increase in production cost of \$330 per animal. In a second study of 14 herds, it was found that 20.1% of the cows had a rumen pH of 5.5 or less. In a third study, it was found that peri-partum cows had a rumen pH of 6 for 5 hours per day and lower than 5.6 for 1 hour per day.

It is difficult to assess the prevalence of SARA, but it is likely to be present worldwide in any dairy herd in which there is heavy feeding of energy.

The decrease in pH associated with SARA is due to an increase in volatile fatty acids (VFA) production in the rumen rather than an accumulation of lactate. Lactate accumulation normally occurs under acute acidotic conditions. Unlike acute ruminal acidosis, SARA does not result in obvious symptoms of disease.

It has been found that the pH of the rumen contents is relatively normal for a few hours around calving simply because the intake of feed is so low.

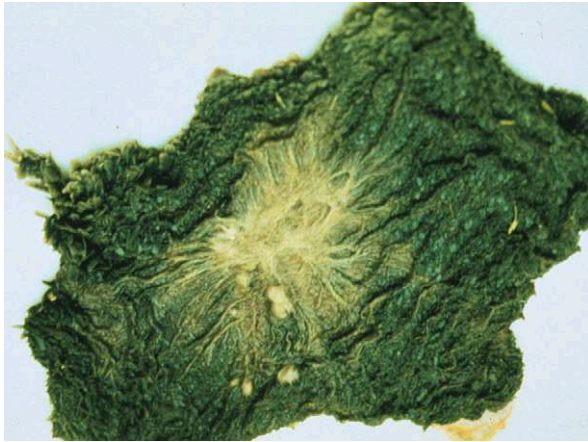
## Description and Diagnosis of SARA

### Early Clinical Signs

- A moderately distended rumen, the contents of which may feel pasty.
- A variable feed intake pattern.
- Suboptimal animal performance.
- Poor body condition despite adequate energy intake.
- Liver abscesses without obvious cause.
- Abomasal disease.
- High cull rate.
- Poor therapeutic response to conditions such as mastitis and metritis.
- Suspicion of immunosuppression in the herd.

See Figures 5-1–5-3.





**Figure 5-1** The rumen of a cow showing a 'stellate scar' which is evidence of chronic ruminal erosion. Most commonly caused by rumen acidosis. The tissue measures 18 × 28cm. (Courtesy of G R Oetzel)



**Figure 5-2** Mild diarrhea in several cows in a group. (Courtesy of K Nordlund)



**Figure 5-3** One of the causes of epistaxis in cattle is SARA. (Courtesy of K Nordlund)

### **Milk Fat:Protein Inversion**

Milk fat:protein inversion has been commonly used by investigators as a signal of ruminal acidosis. It is useful to monitor the prevalence of milk fat less than 2.5%. It is recommended a herd investigation be conducted if the fat percentage drops below this level in 10% of the herd. Mature equivalent 305-day milk (ME305) can be another indicator of ruminal acidosis. If the ME305 of mature cows is less than that of animals in their first lactation, acidosis may be suspected.

### **Rumen Fluid Analysis**

If the ration is fed as separate components, rumen fluid samples should be taken between 2–4 hours after the cow has consumed the main concentrate meal of the day. If the ration is fed as a total mixed ration (TMR), the samples should be taken 4–8 hours after the cows gain access to fresh feed.

Samples collected by stomach tube are of limited value as contamination with varying quantities of saliva distort the results. The equipment used is difficult to manipulate and very difficult to clean and sterilize. Samples obtained by either the oral route or by the use of a cannula tend to show a higher pH value than those resulting from rumenocentesis.

## **TECHNICAL COMMENTS**

### **Rumenocentesis**

A disposable needle 4–5ins long (e.g., from Air-Tite Products Co., Inc., 565 Central Drive, Virginia Beach, VA 23454) is inserted into the rumen. Fluid is withdrawn gently until the needle blocks. The flow is then gently reversed to clear the blockage and then withdrawal of fluid is resumed. It is essential not to create negative pressure inside the syringe as this will cause CO<sub>2</sub> to be withdrawn from the fluid, thereby increasing the pH.

The use of pH indicator paper produces unsatisfactory results as the greenish colored fluid is difficult to match accurately.

If 12% of the cows sampled have an average pH of less than 5.5, it can be concluded that the group has subacute rumen acidosis.

Subcutaneous abscesses may occur in 1–2% of animals sampled.

See Figures 5-4–5-6.



Figure 5-4 The location of the puncture site on the left side of the animal is on a horizontal line level with the top of the patella about 15–20cm caudal to the last rib. The site is clipped, scrubbed, and sterilized. (Courtesy of K Nordlund)

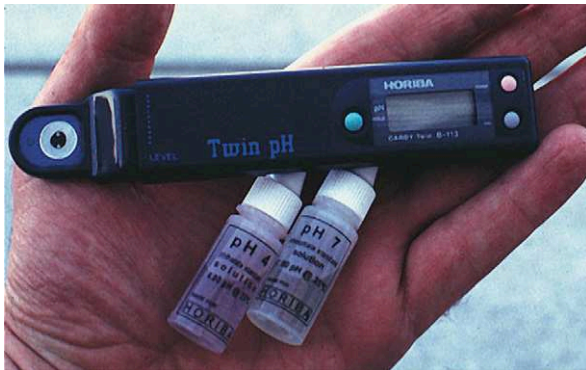


Figure 5-5 The Cardy Twin pH meter (Special Technologies, Inc., Plainfield, Illinois 60544). It is recommended that the electrodes are soaked in water while the samples are being collected. The instrument should be calibrated before use and tested against standardized solutions after use. (Courtesy of K Nordlund)



Figure 5-6 Rumen fluid samples can be stored and tested after as much as 7 hours provided they are kept cold. (Courtesy of K Nordlund)

## OTHER FACTORS THAT SHOULD BE CONSIDERED WHEN EVALUATING NUTRITION

### KEY CONCEPTS

- Investigating nutritional problems in a way, is a detective process of ‘*observing the observable.*’
- Simply asking questions does not necessarily produce correct information. Curiosity and the use of the senses (sight, touch, and smell) have to be used to discover the reality.

### Some Ideas About Curiosity

- *Simple human error* such as a dairy manager failing to report significant changes in ration ingredients to nutrition advisor.
- *Color differences* in the feed can be seen in different parts of a storage facility.
- *The feel* of the ration being fed can differ from one that had been previously fed.
- *Documented evidence* should be reviewed when it is available (invoices, weigh bills, etc.) to support the history of a ration change. The dates on which new sources of feed have been brought on line provide important guidelines.
- *Increase in the size of the herd* creates a demand for forage to be purchased commercially. This practice creates a serious risk in that the fiber quality of the forage imported will be variable. A difference, between loads, of 5% in the acid detergent fiber (ADF) can have quite serious consequences. This is less likely to occur if batches are routinely mixed over 7–10 days.

### TECHNICAL COMMENTS

#### Microorganism population of the rumen

Following an increase in carbohydrate intake, there will be a change in the make up of the microorganism population of the rumen.

Time is needed for acid-intolerant lactate-utilizing bacteria to be replaced by more acid-tolerant lactate-utilizing bacteria and to allow them time to alter rumen fermentation.

Under normal circumstances, ruminal lactate levels are negligible because the small amounts of lactate produced are quickly metabolized. Ruminal lactate concentration increases when *Streptococcus bovis*, a Gram-positive cocci, ferments carbohydrates to lactic acid. This lowers the rumen pH and facilitates the proliferation of *Lactobacillus*. Thus lactate-producing bacteria will result in a spiraling effect where pH is lowered further and ruminal lactate concentration increases.

#### Development of the papillae of the rumen

Volatile fatty acids (VFAs) produced by microorganisms in the rumen are passively absorbed through the papillae of the rumen wall. A low rumen pH is caused

by a combination of VFA and a low supply of saliva and dietary buffers. Accumulation of VFA is due to a highly fermentable diet, particularly one where a large proportion of the diet is highly processed feedstuffs rich in starch and sugar.

Mean surface area of rumen papillae has been found to increase from 10mm<sup>2</sup> to 60mm<sup>2</sup> when exposed to high-concentrate rations, but the process takes 4–6 weeks. This increase triples the amount of VFA absorbed. Therefore, it can be concluded that if papillae were not to elongate adequately through the transition period, the rumen may not be able to cope with increased acid production. If the absorption of VFA from the rumen does not keep pace with the production, the ruminal VFA concentration increases and the rumen pH decreases.

The physical form of the diet can affect the development of rumen papillae in 18-month-old calves. This failure will compromise the animal's ability to absorb VFA. However, it is thought that introducing hay to calves less than 8–12 weeks of age does not develop the rumen and VFA are produced only in minimal amounts in young calves.

See Figures 5-7 and 5-8.

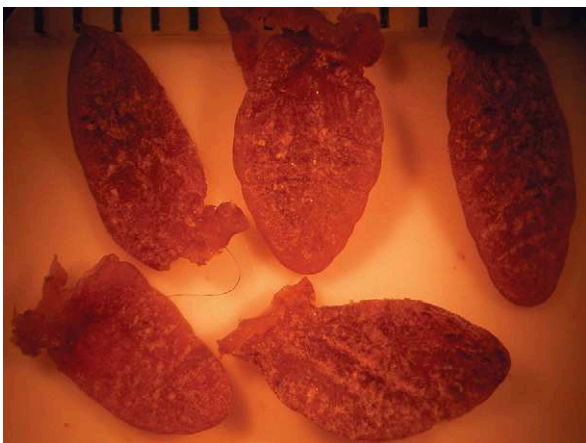


Figure 5-7 This is a biopsy of rumen papillae harvested 14 days before the cow in Fig. 5-6 calved. (Courtesy of G Penner)



Figure 5-8 These are other rumen papillae harvested from the same cow as in Figure 5-6 but 70 days after she calved. Note the significant increase in size. (Courtesy of G Penner)

## The Importance of the Components in a Ration

### Carbohydrates

#### KEY CONCEPTS

- Cereals are essential to provide the energy to drive milk production, but at the same time they are the fuel to create SARA.
- The more rapidly cereals are digested the greater will be the severity of SARA and the cascade of physiological events finally resulting in subclinical laminitis.
- In general the coarser the feedstuff, the drier the feedstuff, the better non-structural carbohydrate will be tolerated by the animal.

When large quantities of highly digestible carbohydrates are fed over a short period, there will be a subsequent rapid drop in rumen pH. On the other hand, if slowly digesting carbohydrates are fed in several meals, the rumen pH may not even drop below the threshold.

Around 10–35% of non-structural carbohydrates are digested in 1 hour compared with only 2–10% of non-structural carbohydrates being digested during the same period. Therefore, factors decreasing the length of time the feed is in the rumen will decrease the amount of feed broken down by bacterial fermentation. The most important factors slowing down the passage of carbohydrates through the rumen are the quality and quantity of fiber in the rumen and the formation of the rumen mat.

The digestibility of grains is quite variable. When processed the same way, oats has the fastest rate of digestion, followed by wheat, then barley, then corn, and finally sorghum. However, when a cereal is processed, effective ruminal digestibility is increased. For example, 45% of coarsely cracked corn is digested. If the shell were fully cracked, the digestibility could rise to 53%, but if the corn were finely ground, 75% would be digested. Finally, if the corn were steam-flaked, up to 90% of it might be digested. The extent of digestion also increases the higher the moisture content in the grain.

Processed grain is more expensive than unprocessed grain, but its use will maximize milk production. Feeding highly digestible carbohydrates has been associated with an increase in the incidence of laminitis.

The cost of commodities determines the composition of rations to some extent. As a general rule, manufac-

turers of feedstuffs will take this into consideration and make adjustments to compensate for higher or lower digestibility of the product being introduced. However, some producers formulating their own ration may fail to appreciate the significance of cereal digestibility. Even this may not be a problem provided that the change from one formulation to another is a gradual process.

### Forage

#### KEY CONCEPTS

- The percentage of effective fiber in forage can be regarded as the 'antidote' to SARA.
- The effectiveness of fiber is reduced if the particles are chopped too small or when the size of particles is reduced if the feed is over-mixed.
- Very long forage in a TMR has been shown to promote 'sorting.'

Diets low in fiber are often associated with:

- Ruminal acidosis.
- Reduced rumination, saliva secretion.
- Lower acetate-to-propionate ratios and milk-fat depression.

### Types of Fiber

*Chemical fiber:* This is expressed as the percentage of neutral detergent fiber (NDF) derived from plant cell walls and their contents which can be converted to starch (structural carbohydrates). This form of energy should balance the energy provided from cereal sources which are expressed as non-structured carbohydrate (NSC).

*Physical fiber:* This is the effective fiber (eNDF) which is needed to make the rumen function properly – the 'scratch' factor which stimulates the process of rumination, salivation, and ultimately helps minimize the drop in rumen pH.

One or other of the following signs may indicate a shortage of effective fiber in the diet:

- Loose manure.
- Reduction in rumination time.
- Craving for bedding or soil.
- Over 10% of the herd have milk-fat levels less than 2.5%.

### The Importance of Particle Size

#### KEY CONCEPTS

- Chewing activity is usually a good indication of rumen health as chewing stimulates saliva secretion.
- Forage particle size has no effect on the intake of dry-matter (DM), but time spent eating and ruminating each day is reduced when short silage is fed.

The physical stimulus of a diet promotes chewing and rumination, resulting in more saliva production and hence rumen buffering. Saliva has been estimated to supply 70–90% of the fluid and buffering capacity entering the rumen. Each cow can produce 108–308 liters (23–68 imperial gallons or 28–81 US gallons) of saliva each day. Saliva is very high in buffers (sodium bicarbonate) and, consequently, plays a very major role in controlling acidosis. However, there appears to be a limit to the relationship between chewing and salivation. Total chewing and rumination times per kg of DM intake decline as milk production and DM intake increases, but it is negatively correlated with milk production. Thus in high-yielding dairy cows, it may be difficult to avoid conditions that predispose the cow to SARA.

A number of 'screen particle separators' are on the market which are able to give the producer a handle on the particle size of the feed consumed by the cow.

Long chop for silage may compromise compaction of the stack and result in more aerobic spoilage, growth of mycotoxins, and reduced feed value. Therefore, farmers prefer to chop the forage as small as possible since it is easier to compact in the bunk. The down side of chopping too finely is that the value of the effective fiber is reduced significantly by small particle size. Adequate particle size in the ration appears to be necessary to avoid low milk fat and avoid depressed rumen pH. It is important to note that some mixers and silage unloaders may reduce particle size below acceptable levels.

Forages should be chopped to contain 25% of the particles over 5cm (2ins) long.

A finely processed ration will reduce rumination time by 2.5 hours with a corresponding decrease in buffer production (in saliva) of 258g/day.

See Figures 5-9–5-11.



**Figure 5-9** The Pennsylvania State Separator consists of three boxes and a pan. Between each box there is a sieve with holes decreasing in size. The material to be examined is placed on the uppermost filter and shaken from side to side 40 times. The boxes are rotated one-quarter turn every five shakes. The larger particles on the top screen will float in the rumen and require more chewing. The particles in the middle box will be digested more slowly, while those in the bottom box will be fermented rapidly and pass out of the rumen quite quickly. (Courtesy of R Shaver)



**Figure 5-10** There are many designs of mechanical feed mixers. In this case a paddle does most of the mixing while the screw delivers the final mix. The efficiency of any mixer depends on the operator mixing consistently and according to the instructions of the manufacturer. (Courtesy of K Nordlund)



Figure 5-11 In this case the two screws on either side of the bin mix in opposite directions and the screw in the base performs the delivery. (Courtesy of K Nordlund)



Figure 5-12 Some cows sort against particle size and sort relatively more energy particles from a mix than other animals. (Courtesy of K Nordlund)

### Sorting

#### GLOSSARY

**Sorting:** This is the skill that some cows have in separating and consuming the concentrate component of a TMR.

A total mixed ration (TMR) may be formulated perfectly, mixed perfectly, be of excellent particle size, but fail to provide adequate effective fiber for some cows because they are skilled 'sorters.' This means that in some well-run establishments where maximum energy rations are offered some cows can still develop SARA. However, it has been reported that cows that can sort against coarse TMR particles may have a higher milk yield. If sorting by cows is a problem, one or more of the following options might be considered:

- Feed smaller amounts of TMR more frequently.
- Add less hay to the mix.
- Process hay finer.
- Use higher-quality hay.
- Use hay that is more pliable.
- Process corn silage.

- Add water to dry TMR.
- Add a liquid feed supplement to the TMR.

See Figure 5-12.

#### **Corn (Maize) Silage as a Source of Fiber**

Corn silage is a nutritious, widely used forage for dairy cattle. Anecdotally, it is often found in practice that feeding corn silage and subclinical laminitis go together. Excellent though corn silage is as a feed, it is a common mistake to underestimate its potency. The problem would be less likely to occur if dairy farmers were to obtain an analysis of the content of the silage, but this is an expense that many are unwilling to bear. From a practical perspective, if laminitis is suspected in a herd fed corn silage, an effective interim measure would be to offer 10% of the forage as long hay.

#### **Harvesting Corn (Maize) Silage**

#### GLOSSARY

**Milk Line:** The corn kernel milk line is the junction between liquid and solid starch granules. To check, break several cobs in half and examine kernels on the face of the tip half.

The stage at which the crop is harvested is highly critical to the non-structured carbohydrate and fiber content of the resulting silage. Consistency in the stage at which the crop is harvested is probably more important than the stage itself. Whole plant moisture should be adjusted to match the type of storage structure used. Corn silage should be harvested between 68–70% whole plant moisture for maximum yield and optimum fermentation. If a silage moisture tester is unavailable, evaluating the 'milk line' on the grain kernel would be helpful (Fig. 5-13). In an upright silo, if the milk line is at one-third, the moisture would be approximately 67–72%; whereas if there were a two-thirds milk line, the moisture would be approximately 63–68%. In sealed silos, the moisture content would be considerably less.

Due to the 'stay green' qualities of some varieties of corn it is now recommended that the producer physically measure the moisture content of corn silage. Unfavorable changes in the weather during harvest can result in delays that inevitably cause alterations in the quality of the crop. A week's delay during warm rainy weather can dramatically change the carbohydrate: fiber ratio of the crop.

If an entire crop has been planted to mature at the same time it may be impossible due to lack of appropriate equipment or manpower to harvest it all within a reasonable period of time. In this case, it may be appropriate to plan to stagger the times at which maturity occurs or by using strains (cultivars) that mature at different times.



**Figure 5-13** To examine the milk line select several cobs of corn and break each in half saving the conical end for comparison. The junction between the yellow and white part of the kernel is the milk line. If the milk line is  $\frac{1}{4}$  to  $\frac{1}{3}$  the way down the kernel it is a rough estimate that the plant dry matter is about 30–32%. (Courtesy of G R Oetzel)

### Method of Conservation

When silage is conserved in a tower or a bag, the feed is retrieved in reverse order from which it was conserved. For this reason, variations in the quality of the product are more difficult to control. If the silage is conserved in a pit (bunk) silo it is laid down in layers and is, therefore, less subject to the vagaries of weather interfering with harvesting. Furthermore, when the silage is cut at the face all of the different layers will be mixed.

See Figures 5-14–5-17.



**Figure 5-14** Possibly the least problematic method of conservation is the use of a bunk or pit. With this system, effects of variations in the quality of the crop harvested are minimized. Each layer of the crop is mixed after the feed has been cut from the face of the silage. (Courtesy of K Nordlund)



**Figure 5-15** These heavy units compact the silage very effectively, reducing air pockets to a minimum. Good compression reduces the necessity for chopping the crop too small. Good particle size is essential for proper digestion. (Courtesy of K Nordlund)



**Figure 5-16** Tower silos are less popular than they were a few years ago. This is partly because of the capital outlay involved and possibly because the manner in which the crop must be handled. However, the tower silo gives good compression to most of the crop. On the down side variations in quality occur between silos and in some cases even between layers in a silo. (Courtesy of K Nordlund)



**Figure 5-17** Bagging silage is quite popular but has the disadvantage of a tower silo with the added risk of damage to covering and subsequent spoilage of the feed. (Courtesy of K Nordlund)

### Protein

The literature is controversial on the role of protein in the pathogenesis of laminitis. In some cases, feeding protein at levels in excess of 18% has been associated with laminitis. There is no evidence that any one particular source of protein is more dangerous than any other. Grass growing extremely rapidly tends to be low in fiber and can contain up to 30% protein. Protein-rich grass has been associated with the occurrence of grass founder (a laminitis-like condition) but it is unclear to what extent allergic reactions to protein may play a part.

### Supplementary Buffers

A buffer is a component of a ration that can neutralize acid. Fiber is considered to be a natural buffer and acts indirectly by stimulating rumination. Typical inorganic buffers such as sodium bicarbonate can be included in the ration in rates up to 1% of the dry matter. Including more buffer may reduce the palatability of the ration. Although not a buffer, providing rock salt licks will increase salivation in cows, thus increasing the rumen pH.

Magnesium oxide acts as a slow-releasing neutralizing agent in the rumen. Due to different modes of actions, when used in combination, sodium bicarbonate and magnesium oxide may give some synergistic activity to the rumen. Calcium carbonate has poor buffering capacity in the rumen but may act to regulate pH in the intestines.

### Rumen Modifiers

Monensin (Rumensin; Elanco) is an ionophore antibiotic that functions primarily in the rumen by inhibiting certain bacteria. It is claimed that rumensin has been used successfully to control the risk of acidosis. Rumensin is available as a feed additive or as a slow-release capsule containing 32g of monensin. It releases approximately 335mg monensin per day for 95 days. It should be administered 2–4 weeks prior to calving. Virginiamycin (Eskalin; Philbro Animal Health) is highly effective but its use is restricted in Australasia and Europe and under review in the US.

### Poor Feed Delivery and Bunk Management

- Failure to evaluate forage and TMR particle size.
- Failure to evaluate grain moisture content and degree of processing.
- Errors in ingredient feeding rate.
- Limited bunk space (< 0.45m per cow).
- Limited feed access time (16–20 hours per day).
- Restricted feeding versus feeding for 5–10% refusal.
- Inconsistent feeding schedule.
- Inadequate, excessive, or inconsistent mixing of feed.

### Dry Cow Management

Appropriate feeding of dairy cows during the transition period (3 weeks prior to calving until 3 weeks after calving) is critical to avoid acidosis and laminitis. Inappropriate nutrition during this period increases the risk of ketosis,



fatty liver, displaced abomasum, milk fever, and retained placenta. Animals should enter the dry period with a body score of 3.5 and should not gain excessive condition, especially in the last 2 weeks. The evidence of a link between over conditioning (body score 4+) and health problems is inconclusive unless the dry-matter intake is depressed. If this is observed to be the case, the energy level in a TMR should be increased but never above 0.75Mcal NE<sub>l</sub>/lb as this may increase the incidence of displaced abomasum. High body scores are often associated with the incidence of ketosis.

If possible, separate dry cows into groups (strings): far-off dry cows, close-up dry cows and heifers. This permits more precise management of nutrition. A TMR of 0.73Mcal NE<sub>l</sub>/lb and 16% CP should be available at all times to all groups. However, metabolic disorders around calving are a problem – the pre-partum energy in the diet should be reduced and the bulk increased.

### Lead Feeding (Steaming Up)

The dry-matter intake of dairy cows declines by about 5% per week commencing at around 6 weeks before calving. During the last 4–5 days before calving, the dry-matter intake may drop by 30%. This fact is often overlooked by dairy producers and makes it difficult to manage in small herds (under 100 head). For this reason, it is important to gradually increase the dry-matter intake during the 2 weeks prior to calving. This is done by offering the cow increasing quantities of carbohydrates. When concentrates are to be offered after calving, then the gradual addition of concentrates to dry-cow rations 2–3 weeks before calving at levels up to 0.75% of body weight is essential in order to avoid sudden increases in carbohydrates after calving.

Feeding concentrate prior to calving stimulates the development of rumen papillae and this will increase milk production. However, too heavy concentrate feeding prior to calving can also increase an animal's predisposition to laminitis. For the small farmer, managing lead feeding requires much attention and a great deal of skill. The safest method for the small farmer to manage the pre-calving feeding is to use a total mixed ration.

### After Calving Management

#### GLOSSARY

**Puffy Feet:** This is the term used to describe slight swelling and pinkness of the skin around the heel bulbs and dew claws.

The 60 days after calving is a critical period for the onset of acidosis. A severe episode of acidosis during this period can lead to damage to the corium of the digit that may affect an animal adversely for the rest of her life. This is especially the case with heifers following their first calving.

All cows do not have an equal genetic capability to adapt rapidly to the consumption of carbohydrates. It is normal to find some cows in an intensively managed herd to have 'puffy feet' for a few days after they calve (Fig. 5-18). This sign is indicative that the animal is accommodating poorly to an increase in concentrates. It is only of concern if it persists or is present in every cow that calves. If the manure of animals with 'puffy feet' is softer than that of other cows the energy in the diet of the affected cow should be reduced.

- Cows should be consuming about 5kg of concentrate at calving and held at that level for 3–4 days. Concentrate can then be increased by 0.20kg/day for first-calf heifers and 0.25kg/day for mature cows.
- The final feed intake should provide a minimum of 18–21% ADF from forage.
- Provide one computer feeder per 20 cows when this equipment is employed.
- Avoid sudden changes in major components of rations; changes should take place over at least 2 weeks.
- Increase concentrates gradually over the first 6 weeks after calving.
- Avoid NSC exceeding 35% of the ration dry matter.
- Do not use inorganic buffers at a rate greater than 1% of the dry-matter intake.



**Figure 5-18** Some recently calved cows that are having difficulty accommodating to a ration may show slight puffiness and pinkness around the coronary skin and around the dew claws. This is a useful hint that the nutritional program is set at too high a level.

## Manure Watching

Examination of the manure is another way in which effective fiber can be evaluated. One cup of fresh manure should be placed on a wire screen, such as a kitchen sieve (mesh of 6–8 squares per inch). The manure is washed under pressurized water and the material remaining is evaluated:

- Forage particles in the manure over 1.5cm (0.5ins) in length will reflect a rapid rate of feed passage.
- The appearance of whole or partial grains indicates poor carbohydrate utilization. The appearance of grains of cereal could be related to improper corn silage chopping, corn silage that is too mature, corn silage that is too dry, corn grain that is too coarse, corn grain that was dried too fast, the existence of a poor rumen environment, the too rapid rate of passage or a lack of a dry cow transition diet.
- Bubbles in the manure indicate that carbohydrate fermentation has been taking place in the hind gut. That is, the grains passed too rapidly through the rumen, possibly because of inadequate effective fiber. This indicates that there has been damage to the hind gut. In some cases, gelatinous 'casts' of mucus will be present as a further indication of hind-gut damage.

## Component Feeding Versus Total Mixed Ration (TMR)

### Component Feeding

#### KEY CONCEPT

- When concentrates and forage are fed separately, concentrates should be fed 4–5 times per day.

Some dairy producers with small herds 'component feed' their cows. That is to say, the concentrate component is fed separately from the forage. A TMR may be fed for maintenance and the concentrate offered according to

production. However, during the transition period the concentrate dry matter should be restricted to 0.75% of the animal's body weight.

If the method used were to allow the cow to 'choose,' she would consume relatively more concentrate than forage. This will precipitate acidosis. Although not proven scientifically, some workers believe that when acidosis occurs at calving it alters the critical hormonal turmoil of the period sufficiently to precipitate laminitis. This might be an explanation of the seriousness of laminitis being seen in heifers after they calve for the first time.

If cows were allowed to consume proportionately more concentrate before they calve, they would be at greater risk of left abomasal displacement (LDA) due to low rumen fill. At the other extreme, feeding minimal grain before calving may also increase the risk of LDA through failure to increase the volatile fatty acid absorptive capacity of the rumen papillae and allow sufficient time for microbial population changes in the rumen prior to feeding high-energy diets after calving.

### Total Mixed Ration

A total mixed ration, as the term implies, will have all the required ingredients mixed into one ration. Using a TMR can also run into problems when it is misapplied. Certainly, if the same TMR were fed ad lib to all cows and heifers irrespective of their position in the calving cycle, laminitis-like changes would probably occur. Some cows, relative to their actual nutritional requirements, will be over-fed while others may be under-fed at peak lactation, leading to reduced production.

Ideally, in large herds the animal population can be broken down into groups. Each grouping is based on its appropriate nutritional requirements. That is to say, there would be a heifer group, a dry-cow group, a close-up and the recently calved group, a peak-lactation group, and possibly a drying-off group. Each group receives individual attention. This practice is particularly advantageous for heifers removed from 'social confrontation' with dominant cows during their critical first lactation. However, the system is labor intensive and, for this reason, subject to modifications which can introduce risk factors. For example, it is often found that the best forage is included in the ration for one group and inferior, less expensive, forage given to another group. The quality of forage is the critical component in

the balance between concentrate and fiber. If there were a serious and dramatic change in the fiber quality between the ration of one group and another, laminitis may result.

## Feeding Behavior

See Figures 5-19 to 5-22.



**Figure 5-19** Animals feeding from a circular bunk eat for 26% shorter time than those fed from one along a fence line of a dry lot or corral.



**Figure 5-20** Shaver Cows feeding at floor level produce 17% more saliva than those feeding from a raised bunk. Use of a manger curb prevents the scattered feed from being adjusted with a mechanical grader. Cable neck restrainers should be avoided.



**Figure 5-21** In this picture the cows are waiting to be fed and can hear the arrival of the feed cart. However, if animals come to the bunk at other than feeding times it probably indicates they are being under fed. (Courtesy of K Nordlund)



**Figure 5-22** Ten percent of cows feeding from bunks elevated 60–70cm above the ground will play with and 'sort' the feed. They throw the forage in the air and 0–5% of the feed is wasted. (Courtesy of K Nordlund)

## BIBLIOGRAPHY

Bailey C B 1961 Saliva secretion and its relation to feeding in cattle: 3 The rate of secretion of mixed saliva in the cow during eating, with an estimate of the magnitude of the total daily secretion of mixed saliva. *British Journal of Nutrition* 15:443–451

- Burato G M, Voelker J A, Allen M S 2001 Effects of pretrial milk yield on the feed intake, production, and feeding behavior responses to forage particle size by lactating cows. *Journal of Dairy Science Suppl 1*:(abstract).
- Cameron R E B, Dyk P B, Herdt T H 1998. Dry cow diet, management, and energy balance as risk factors for displaced abomasums in high producing dairy herds. *Journal of Dairy Science*. 81:132–139
- Carter R R, Grovum W L 1990 A review of the physiological significance of hypertonic body fluids on feed intake and ruminal function: salivation, motility and microbes. *Journal of Animal Science* 68:2811–2832
- Crookson R K, Kurlle J E 1988 Using the kernel milk line to determine when to harvest corn silage. *Journal of Production Agriculture* 4:293–295
- Dado R G, Allen M S 1994 Variation in and relationships among feeding, chewing, and drinking variables for lactating dairy cows. *Journal of Dairy Science* 77:132–144
- Dirksen G U, Liebich H G, Mayer E 1985. Adaptive changes of the ruminal mucosa and their functional and clinical significance. *The Bovine Practitioner* 20:116–120
- Duffield T, Begg R, DesCoteaux et al 2002 Prepartum monensin for the reduction of energy associated disease in prepartum dairy cows. *Journal of Dairy Science* 85:397–405
- Dyk P, Emery R 1996 Reducing the incidence of peripartum health problems. *Proceedings of the Tri-State Dairy Nutrition Conference*, p 41–53
- Erdman R A 1988 Dietary buffering requirements of the lactating dairy cow: a review. *Journal of Dairy Science* 71:3246–3266
- Garrett E F, Pereira M N, Nordlund K V 1999 Diagnostic methods for the detection of subacute ruminal acidosis in dairy cows. *Journal of Dairy Science* 82:1170–1178
- Goad D W, Goad C L, Nagaraja T G 1998 Ruminal microbial and fermentation changes associated with experimentally induced subacute acidosis in steers. *Journal of Animal Science* 76:234–241
- Grant R J, Colenbrander V F, Mertens D F 1990 Milk fat depression in dairy cows: role of silage particle size. *Journal of Dairy Science* 73:1823–1834
- Greenough P R, Vermunt J J, McKinnon 1990 Laminitis-like changes in the claws of feedlot cattle. *Canadian Veterinary Journal* 31:202–208
- Heinrichs A J, Lammers B P 1997 Particle size recommendations for dairy cattle. *Silage: Field to Feed Bunk Processing, Hershey NRAES-99*, p 268
- Heur C, Schukken Y H, Jonker L J et al 2001 Effects of monensin on the blood ketone bodies, incidence and recurrence of disease and fertility in dairy cows. *Journal of Dairy Science* 84:1085–1097
- Herrera-Saldana R E, Huber J T, Poore M H 1990 Dry matter, crude protein and starch degradability of five cereal grains. *Journal of Dairy Science* 73:2386–2393
- Hutjens M F 1997 Evaluating effective fiber. *Proceedings of the 4-State Applied Nutrition and Management Conference*, p 12–18
- Kaufmann 1976 Influence of the composition of the ration and feeding frequency on pH regulation in the rumen and on feed intake in ruminants. *Livestock Production Science* 3:103–114
- Kenelly J J, Robinson B, Khorsanai G R 1999 Influence of carbohydrate source and buffer on rumen fermentation characteristics, milk yield, and milk composition in early-lactation Holstein cows. *Journal of Dairy Science* 82:2486–2496
- Krajcarski-Hunt H, Plaizier J C, Walton J-P et al 2002 Short communication: Effect of subacute ruminal acidosis on in situ fiber digestion in lactating dairy cows. *Journal of Dairy Science* 85:570–573
- Leek B F 1982 Clinical diseases of the rumen: a physiologist's view. *Veterinary Record* 113:10–14
- Leonardi C, Armentano D R 2000 Effect of particle size, quality and quantity of alfalfa hay, and cow on selective consumption by dairy cattle. *Journal of Dairy Science* 83 (suppl 1):272 (abstract)
- Lykos T, Varga G A 1995 Effects of processing method on degrading characteristics of protein and carbohydrate sources in situ. *Journal of Dairy Science* 78:1789–1801
- Mackie R L, Gilchrist F M C 1979 Changes in lactate-producing and lactate-utilizing bacteria in relation to pH in the rumen of sheep during stepwise adaptation to a high-concentrate diet. *Applied Environmental Microbiology* 38:422–430
- Mahanna B 2002 Impact points for improving forage quality and consistency. *Proceedings XIIIth International Symposium on Lameness in Ruminants, Orlando*, p 39–50
- Manson F J, Leaver J D 1988 The influence of dietary protein intake and of hoof trimming on lameness in dairy cattle. *Animal Production* 47:191–199
- Martin R 1999 TMR particle distribution analysis at six hour time intervals. *Proceedings Arlington Dairy Day, Arlington, Wisconsin*
- Martin R 2000 Evaluating TMR particle distribution: a series of on-farm case studies. *Proceedings of the 4-State Professional Dairy Management Seminar, Dubuque*
- Mertens D R 1997 Creating a system for meeting the fiber requirements of dairy cows. *Journal of Dairy Science* 80:1463–1481
- Meyer R M, Bartley E E, Morill J L et al 1964 Salivation in cattle. Feed and animals factors affecting salivation and its relation to bloat. *Journal of Dairy Science* 47:1339–1345
- National Research Council 2001 Nutrient requirements of dairy cattle, 7th revised edition. National Academy of Science, Washington
- Nocek J E 1997 Bovine acidosis: Implications on laminitis. *Journal of Dairy Science* 80:1005–1028
- Nordlund K V 2001 Herd based diagnosis of subacute ruminal acidosis. *Preconvention Seminar 8: Dairy Herd Problem Investigations. American Association of Bovine Practitioners 34th Annual Convention*
- Nordlund K V 2002 Herd-based diagnosis of ruminal acidosis. *XIIIth International Symposium on Lameness in Ruminants, Orlando*, p 70–74
- Nordlund K V, Garrett E F 1994 Rumenocentesis: a technique for the diagnosis of subacute rumen acidosis in dairy herds. *Bovine Practitioner* 28:104

- Nordlund K V, Garrett E F, Oetzel G R 1995 Herd-based rumenocentesis: a clinical approach to the diagnosis of subacute rumen acidosis in dairy herds. *Comparative Continuing Education for Practicing Veterinarians* 17(8):48–56
- Oetzel G R 1999 Effect of ruminal pH and stage of lactation on ruminal lactate concentrations in dairy cows. *Journal of Dairy Science* 82(suppl 1):abstr
- Owens F N, Secrist D S, Hill W J et al 1998 Acidosis in cattle: a review. *Journal of Animal Science* 76:275–286
- Peterse D J 1982 Prevention of laminitis in Dutch dairy herds. *Proceedings of the IV International Symposium on Disorders of Ruminant Digest, Paris*
- Plaizier J C, Martin A, Duffield T 1999 Monitoring acidosis in the transition dairy cow. *Journal of Dairy Science* 82(suppl 1):abstr
- Russell J B, Hino T 1985 Regulation of lactate production in *Streptococcus bovis*: a spiraling effect that contributes to rumen acidosis. *Journal of Dairy Science* 68:1712–1720
- Shaver R D 1997 Nutrition. In: Greenough P R, Weaver A D (eds) *Lameness in cattle*. W B Saunders, Philadelphia, p 293–297
- Shaver R D 1993 TMR strategies for transition feeding of dairy cows. *Proceedings of the Minnesota Nutrition Conference, Bloomington*
- Shaver R D 2002 Rumen acidosis in dairy cattle: bunk management considerations. *XIIth International Symposium on Lameness in Ruminants, Orlando*, p 75–81
- Slyter L L 1976 Influence of acidosis on rumen function. *Journal of Animal Science* 43:910–929
- Soita H W, Christensen D A, McKinnon J J 2000 Influence of particle size on the effectiveness of fiber in barley silage. *Journal of Dairy Science* 83:2295–2300
- Stone W C 1999 The effect of subclinical rumen acidosis on milk components. *Proceedings of the Cornell Nutrition Conference of Feed Manufacturers*, p 40–46
- Thoenfer M B, Pollitt A W, Eps van G et al 2004 Acute bovine laminitis: a new induction model using alimentary oligofructose overload. *Journal of Dairy Science* 87:2932–2940
- Thoenfer M B, Wattle O, Pollitt A.W, French K R, Nielsen S S 2005 Histopathology of oligofructose-induced acute laminitis in heifers. *Journal of Dairy Science* 88:2774–2782
- Vermunt J J 1992 'Subclinical' laminitis in dairy cattle. *New Zealand Veterinary Journal* 40:133–138
- Woodford J A, Jorgensen N A, Barrington G P 1986 Impact of dietary fiber and physical form on performance of lactating dairy cows. *Journal of Dairy Science* 69:1035–1047

# Cow Comfort, Behavior, and Housing

### KEY CONCEPTS

- The environment in which dairy cows are forced to exist under intensive management has been created for the convenience of man rather than the comfort of cows.
- Cattle should be able and willing to lie down for 11–14 hours daily.

### INTRODUCTION

#### GLOSSARY

**Cow Comfort:** This is the quality of environment, including housing, husbandry system, management, and hygiene on which a cow depends to enable it to reach its genetic potential utilizing the nutrients with which it has been supplied.

Although the term ‘cow comfort’ entered the vocabulary of the cattle industry relatively recently, a precise, internationally accepted definition has yet to be determined. Cow comfort first focused on the places where cows rested. The term now includes all areas occupied by the cow – day or night. The reason there has been increasing interest in cow comfort is that it is now believed that negative factors in the environment, facilities, and management cause stress. Stress, in turn, predisposes a herd to diseases, including those causing lameness. The current consensus of opinion indicates that these factors when considered cumulatively increase the effect of errors in nutrition.

Heat stress or extremes of cold negatively affect the metabolism of the cow. Therefore, houses and shelters have been constructed for dairy cows to protect them from extreme temperature variations. However, due to cost of constructions and practical solutions to facilitate management, animals are often confined in a suboptimal environment. Social confrontation or lack of personal space in loose house systems is believed to be a stressor and directly related to the traffic in cattle. Undesirable resting spaces or restricted access to resources causes fatigue. Even under pastoral management, cows are stressed by walking long distances over poorly maintained roadways and being worried by biting dogs or impatient herdsmen.

## THE IMPORTANCE OF A COW'S ABILITY TO REST

### KEY CONCEPTS

- It has been shown that there is a relationship between a cow's unwillingness to lie down and lameness.
- A cow that is lying down is more likely to ruminate and produce saliva than a standing animal. A cow produces 108–308 litres (24–68 imperial gallons) of saliva each day. This is equivalent to 390–1,115g (14–40 ounces) of disodium phosphate and 1,134–3,234g (40–115 ounces) of sodium bicarbonate. Saliva, therefore, reduces (buffers) rumenal acidosis.
- About 3 litres of blood passes every minute through the udder of a standing cow, while about 5 litres will diffuse through the udder every minute when she is lying down. Lying down, therefore, improves udder function and possibly milk production as there is a direct connection between blood volume pumped through the udder and the volume of milk produced.
- A lame cow lies down and rises less frequently than a sound cow, but when a lame cow does lie down she lies for longer periods than normal.
- Standing for prolonged periods causes the blood pressure inside the claws to rise and reduced perfusion of blood will follow. This will result in inadequate oxygenation and nutrition of the horn-producing tissues, which will lose vitality. Reduced circulation of blood through the foot will decrease the removal of toxins.
- If animals are found standing or lying with the rear legs outside of the stall this is a sign of uncomfortable stalls.

The following factors reduce the willingness of a cow to lie down:

- (a) Inadequate numbers of stalls (cubicles) (see p. 74).
  - Restricts the choice of timid cows or inexperienced heifers of where to lie.
  - Increases the risk of cows being injured if they lie in the walkways.
- (b) Unattractive stalls (cubicles) (see p. 75).
  - Any factor that interferes with the forward lunge during rising.
  - Inadequate bedding causing the animal to lie on cold hard surfaces (sand and mattresses are becoming increasingly popular).
  - Inappropriate dimensions and slope.
  - Curbs that are too high.
  - Neck rail too restrictive to allow the cow to stand comfortably in stall (cubicle).
- (c) Forced standing in line (see p. 72).
  - Waiting for access to water (too few or too small waterers).
  - Waiting for access to a computerized feeder.
  - Waiting to be milked.

## Cow Comfort Index (CCI)

The CCI is an innovative method for a dairyman to monitor the level of cow comfort in a herd. The CCI should be calculated (1 hour before milking) as the number of cows lying in stalls divided by the total number of cows touching stalls. The number of cows 'touching stalls' is the sum of the cows lying in stalls plus the cows standing with either two or four feet on the stall surface. In an example pen of 100 cows, 15 are standing in the alleys eating, drinking, and socializing, while 85 are touching stalls. Of the 85 cows touching stalls, 70 are lying down, 10 are perching in stalls with two feet on the stall surface, and 5 more are standing with four feet in the stall. The Cow Comfort Index would be 70 lying divided by 85 touching for a CCI of 82%. There is a correlation between the CCI and the incidence of lameness in a herd. If the CCI in a herd is unacceptable, the cow comfort should be reviewed.

## SOCIAL CONFRONTATION

### GLOSSARY

**Social Confrontation:** The term is used to describe a negative interaction between members of a herd. It is believed to cause stress.

Social confrontation occurs as much between dairy cows as it does between humans. A submissive animal will alter its natural behavior when confronted with a more dominant one. In nature, cattle rely on the social group as a measure of protection. Under domestication, the same instinct is retained but is distorted by man's need to conserve space and reduce labor. Today, dairy cows are forced to live in a more confined environment than ever before. This increases the cow traffic and consequently the risk of confrontation. Reducing population density has been reported to reduce the prevalence of lameness in a herd.

When the incidence of lameness in a herd is high, it is advisable to carefully observe the behavior of the animals, vis-à-vis aggressive behaviour, time spent resting, freedom to access resources (food, water, and rest), and freedom to circulate within the facilities in order to exercise. Social confrontation also increases the rate of slippage and resulting traumatic injuries. A reduced willingness to compete for resources will adversely affect milk production.

## Dominance

In any social group, some individuals are more dominant than others and this defines a certain pecking order. This characteristic is probably mostly a genetic trait, although physical size and experience play a major part. Dominance is not of necessity an aggressive trait, but when it is, it tends to be disruptive in a herd. More frequently, a cow exerts her dominance by her 'presence' which, under natural conditions, has the matriarchal benefit of leadership. Careful observation will distinguish between the two types of dominance (Fig. 6-1). Appropriate long-term culling may be indicated.



**Figure 6-1** Here a dominant cow confronts a submissive heifer seeking water. The cow stands with her head and ears held high while the heifer lowers both ears and head. The eyes of the cow are wide open. (Courtesy of G Jones)

## Personal Space

There is a certain distance within which we, as humans, feel uncomfortable if someone intrudes. Cattle have exactly the same feeling. A dominant cow may have a personal space of 3 feet (1 meter) while an inexperienced heifer may need 10 feet (4 meters) or more. Often this is called the 'flight zone' and is considerably increased when an unfamiliar human being or an animal such as a dog approaches. After cattle have been dehorned, their flight zone is reduced, allowing for more confined conditions than would otherwise have been possible.

The implication of personal space is seen when two cows approach one another in space too narrow to pass without intrusion into the flight zone. This may cause one animal to move away and possibly slip on a curb. Foot and leg injuries are frequently observed even in newly constructed, suboptimal, tie- and free-stall barns.

## Age

### KEY CONCEPT

- Care must be taken when heifers are introduced into groups of mature cows.

Dominance may exist within any age group, but it also exists between age groups. That is to say, heifers are nearly always intimidated by older cows. Some heifers adjust rapidly to the age difference while others are slower doing so. Age should perhaps be expressed as naïveté relative to experience.

The practical lesson is that heifers should, if possible, be held as a separate group during their first lactation. In small herds this is not possible, in which case heifers should not be introduced to an experienced group of cows singly. It is preferable to introduce several heifers at a time to the milking herd during the hours of darkness. In this way, each heifer has a familiar animal with which she can associate. Another technique is to mix dry milking cows with heifers near term in a spacious straw yard. This allows for both groups to socialize before being confronted with exposure to concrete and restricted space.

## FORCED STANDING TIME

When a cow is standing, the pressure inside the claw capsule will increase. Blood will be pressed out of the vascular system and the volume of blood in the claw will



decrease rather than accumulate. It is this pressure on the tissue between the pedal bone and the horn capsule that damages tissues. Hypoxic conditions and ischemia certainly are the consequences of pressure.

Walking pumps blood through the claws, therefore, lack of exercise reduces oxygenation and nutrition of the horn-producing tissues, which will lose vitality. Reduced circulation of blood through the foot will mean that toxins present will not be removed. Long standing time on hard floors increases the load on the feet, introducing the element of trauma into the etiology of claw diseases. Increased exposure to slurry also takes place when the animal stands. The claw horn becomes softer and more prone to injury and erosion.

Herds in which stalls (cubicles) are uncomfortable have a higher incidence of lameness. Heifers lying less and standing longer, due to uncomfortable stalls, have significantly more sole hemorrhages 1 month after calving and more sole ulcers 2 months after calving than the animals using comfortable stalls. The following are risk factors of special interest:

- the holding area
- the availability of the water supply
- the availability of feed in the bunk
- restriction in loafing areas.

## The Holding Area

### KEY CONCEPT

- Cows should not spend more than 3 hours each day waiting to be milked.

As the size of the average herd increases, the size of the milking parlor may remain the same. This difficulty is sometimes overcome by holding the remainder in a secondary, hard-surfaced holding area such as passageways. This means that the cows have to wait even longer to be milked.

Cows need at least 1.3–1.5m<sup>2</sup> per cow to congregate comfortably in a yard. The cows should be able to stand quietly with their heads down and slowly move forward to be milked. Too much space permits too much movement and injuries result. Backing gates should be used with care. The following points are useful when considering the design and management of the holding area:

- Rubber mat surfaces in a holding yard provide the claw with some relief (Fig. 6-2).
- Waiting areas must be covered.



**Figure 6-2** Waiting in line to be milked on a concrete floor causes blood pressure inside the claws to rise and reduced perfusion of blood will follow. (Courtesy of C Bergsten)

- Cows must not wait to be milked on concrete surfaces for a total of more than 3 hours each day.
- The slope (not greater than 4%) of the concrete in the holding area should be sufficient to ensure drainage.
- The waiting area should be hosed down as soon as it becomes heavily contaminated, i.e., several times during milking.
- The surface of the concrete should be maintained in good condition.
- The surface of the concrete should be grooved to ensure a good footing.

## The Availability of the Water Supply

Cows must replace water lost during milking. This usually becomes an urgent requirement within an hour after milking. Therefore, the placement and design of the waterers are of considerable importance. This risk factor is described in greater detail in Chapter 9.

## The Availability of Feed in the Bunk

Feed should be available in the bunk, especially if the herd is overcrowded. Feed should regularly be pushed towards the cow when necessary. If feed is not available for the cows, they will simply stand and wait. The cow should never be left standing at empty bunk.

## Restriction in Loafing Areas

### KEY CONCEPT

- Sufficient exercise (stimulating blood flow through the feet) is an important factor in maintaining claw health.

A loafing or exercise area should be calculated at not less than 3.3m<sup>2</sup> (35.5ft<sup>2</sup>) per cow. Space is used very competitively between rows of stalls, or alleys between stalls and feed bunks, around drinking troughs, in milking parlor holding pens, crossover alleys, and at entries and exits to the barn or alleyways (Fig. 6-3). Space available in these ‘strategic sites’ must be generous if a cow is to have sufficient personal space for flight and to accommodate aggressive encounters between the various animals in the social hierarchy. Narrow alleys are the common cause of social confrontation.

- Stall alleys should be at least 3.75m (12ft) wide.
- A combined feed and stall alley should be at least 4.25m (14ft) wide.
- Crossover alleys should be 4.25m (14ft) wide plus one additional meter for each water trough located on either side.

If an animal is found lying in the walkways, it is a sure sign that she is reluctant to use the stalls (cubicles) available. In this case, a review of the lying comfort (i.e., bedding, dimensions of cubicle) is required.

The slope of the alley should be about 1.5–2.0% from its crown and in its length.



**Figure 6-3** This is a very cramped alleyway which provokes confrontation between two animals trying to pass in the narrow space available. (Courtesy of C Bergsten)

## SUITABILITY OF HOUSING

### KEY CONCEPTS

- If less than 98% of cows use stalls, the cause of stall rejection should be investigated.
- Ideally there should be more than one stall per cow. If first-calf heifers are included in the group, there should be at least 10% more stalls than animals.
- Increasing herd size can have hidden problems.

The more restrictive the spaces, the more destructive to harmony within the herd will dominance become. Many producers are forced, for economic reasons, to increase the size of their herd. This places pressure on existing facilities which were designed for a smaller population of cattle. Often forgotten too is the fact that facilities were originally designed as a tie-stall operation and then modified as a free stall. This forgotten event causes problems of social confrontation as the traffic of cattle increases along alleys that are too narrow for the population.

Increasing the length of a barn is a frequent solution to increasing herd size simply because it is architecturally too expensive to increase the span of a barn with all that it implies. Competition for water may be critical if waterers have been installed for a smaller cattle population. When an increase in the size of the herd is planned, it must be done so in a historical perspective with the needs of the new population taking priority.

### Dimensions and Features of the Ideal Free Stall

Exact measurements depend on the size of the animals being housed. Compromises are always made between enough space for natural behavior of the cows and necessity to maintain good stall hygiene. Please note that suggested guidelines do not apply under every circumstance. Cows of different frame size should not be mixed in the same herd. Stalls designed for the largest cows usually means that smaller cows will have a higher risk of becoming dirty. If it is believed that there is a ‘cow-comfort problem,’ it is advisable to consult an expert if the intention is to make architectural changes in buildings.

See Figures 6-4–6-7.

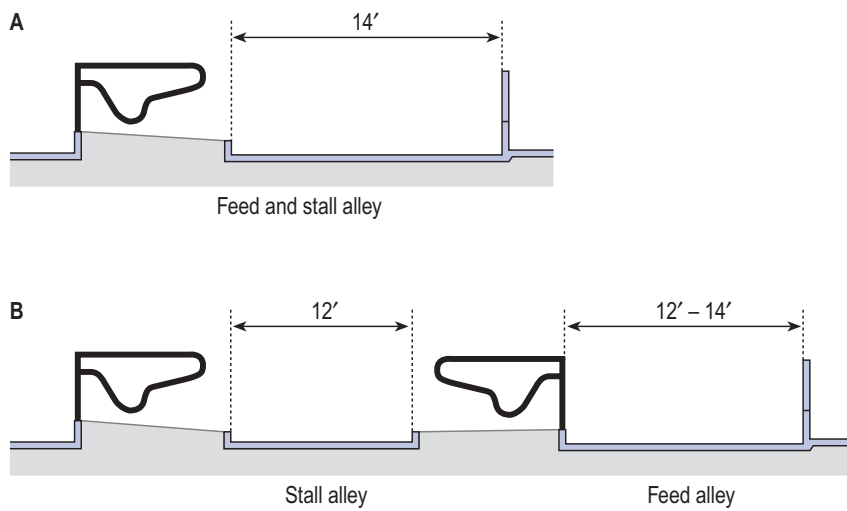


Figure 6-4 Irrespective of the alley type, space must be sufficient to permit two cows to pass without touching even if cows are occupying stall and/or feed bunks.



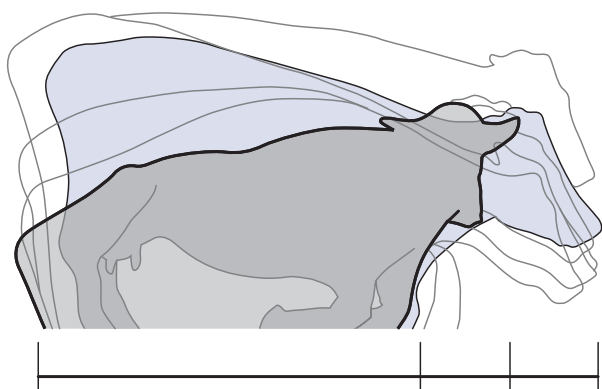
Figure 6-5 If the length of the stall is too short for the animal or if bedding is piled high in the front of the stall, the body and legs of the animal will slide over the curb. Physical damage of protruding, unprotected body parts like the hock will result.



Figure 6-7 This 'space sharing' design provides zones of free space for the head, ribcage, and pelvic area. The bottom rail of the partition should be set at 25-28cm (10-11ins) above the resting surface near the brisket locator and the top rail of the partition at from 111-117cm (44-47ins) from the floor. (Courtesy of K Nordlund)



Figure 6-6 In this case, the partition is not of the space-sharing design. The back of the partition is less than the recommended 35cm (14ins) in front of the curb. Hind legs can become entangled in the upright pipe. Note also that the cows are facing a wall, causing lunge space to be absent.)



**Figure 6-8** When a cow comes to her feet, she must lunge forward to do so. The forward lunge space demanded by a 600kg (1,300lb) Friesian dairy cow is 1–1.5m (40–60ins). Therefore, as she lunges forward to rise the total stall length needs to be at least 2.70m (106ins).

### TECHNICAL COMMENTS

The length of the stall should be 2.5–2.8m (98–110ins), depending on the stature of the cow.

The width of the stall should not be less than 1.2m (47ins) except for stalls used exclusively by heifers. However, if stalls are too wide, the cows may lie diagonally and defecate in the stall.

Neck rails should be located 1.7m (67ins) forward of the curb and 90–106cm (37–43ins) above the level of the stall. This will give a diagonal of 2.00m which is a practical measurement to use when checking. Stall refusal is often caused by placing the neck rail too low.

Cables should never be used.

### Lunge Space and the Brisket Board

Providing space to lunge in a stall is attractive to a cow. A stall that is too short and/or has a wall in front is a very common cause for a free-stall to fail to function properly. With a long enough lunge space the cow will lie forward in the stall. The brisket board then limits the cow's lying position and should reduce waste accumulating at the rear of the stall.

For side lunging, the lunge space can be halved. However, attempting to compensate for the shortness of a stall by providing a side lunge will make the cow lie diagonally in the stall, forcing her limbs into her neighbor's space.

See Figure 6-8.

### Slopes

See Figures 6-9 and 6-10.



**Figure 6-9** Front to back slope of a stall should not be greater than 4% (4cm in each meter). If the slope is increased by packing bedding at the front of the stall, the cow will stand back in the gutter.



**Figure 6-10** The slope down the barn should be 1.5–2.0% to encourage all of the cows in the barn to lie with their feet down the slope. When cows all lie on the same side, there is less risk of damaging a neighbor when the animal rises. (Courtesy of R Shaver)

## Stall Floor Surfaces and Bedding

### KEY CONCEPTS

- Cows increase their lying time (by 1.8–4.0 hours per day) on a soft-bedded stall compared with those having a concrete surface. They also have more difficulty rising if the surface of the stall is concrete.
- Cows may prefer to lie on rubber mats but this is only a 'band aid' if the design of the stall is flawed.
- Mats and mattresses always require some litter to absorb moisture.

The base and the bedding of a stall have a profound effect on the behavior and lying time of a cow. Cows will lie for as many as 14 hours in the most comfortable cubicles. The more resilient and soft the lying surface, the longer the cow will rest. However, the length of a lying interval is longer on concrete, presumably because cows are less willing to lie down and rise on such a surface. The lying interval is also associated with the space and design of the stall.

A sand bed (Fig. 6-11) seems to be the most acceptable to cows, particularly in warm climates. Sand bedding clogs normal drainage systems, therefore, a sedimentation trap must be constructed.

In Sweden, a successful stall system has been developed in which the back 30cm (12ins) of a stall consists of rubberized slats to improve cleanliness.

The following factors have to be considered regarding bedding:

- The thermal comfort of a dairy cow depends on the top layers of the lying area.
- Straw or sawdust absorbs moisture; wet bedding encourages bacterial populations to increase.
- Manure from the cow's feet also contaminates the lying area.
- Short, fine bedding reduces the amount dragged into alleys.
- Loose bedding should be checked twice daily.
- More material should be added once each week.
- Too much bedding should not be thrown to the front of the stall.

Individual solid or honeycomb rubber mats in stalls have been found to be effective in reducing foot problems. Significantly, more white line hemorrhages are found in the cows using a stall with a concrete floor compared with those bedded on rubber mats.

### TECHNICAL COMMENTS

Individual mattresses are made of a tough interwoven material and sewn into longitudinal segments. The segments are filled with an inert rubber material such as ground rubber. The individual mattresses, one per stall, are covered with one continuous top sheet. The material is very resilient and appears to distribute the load, especially from bony protrusions, uniformly into the mattress.

Full barn mattresses are constructed by rolling tough fabric 3.0–3.5m (118–137ins) wide down the entire length of the alley. One side of the strip is fixed to the curb with lag bolts. Straw or other material (chopped rubber) is placed over the stall to a compressed thickness of 10cm (4ins). The free edge is then folded over the bedding and fixed at the front of the stall. This system is losing popularity and is rarely found in European barns.



Figure 6-11 Stalls bedded with sand provide the lying surface most preferred by dairy cows. (Courtesy of G Jones)

## Traditional Feed Stalls and Bunk Space Size

### KEY CONCEPTS

- 60cm (24ins) of bunk space should be allowed for each cow.
- At least one space for each cow should be provided.
- If first-calf heifers are included in the group, the number of spaces should exceed the number of animals by 10%.

With head gates (Fig. 6-12), the bunk space measurement depends on the size of each gate and not on available length of the manger. In North America it is common to describe bunk space as the number of inches that should be allowed for each cow. Swedish legislation allows three cows per head gate, provided that feed is available 24 hours per day.

### Individual Feed Stalls: A New Concept

The feed stalls should be 1.60–1.65m (63–65ins) from front to back and elevated 0.2m (8ins) above the alley.

Dividers between each cow are needed to prevent cows from walking and defecating on the platform. The recommended width between dividers should be 0.70–0.80m (28–31ins).



**Figure 6-12** Head gates provide excellent control of social confrontation. However, leaving cows locked in the gate overnight by accident causes considerable damage to the feet. (Courtesy of R Shaver)

Providing rubber mats is of highest importance to fully explore the advantage of the feed stalls. However, the floor of the feed stall must not be more attractive than a resting stall otherwise access to the feed bunks will be restricted.

Individual feed stalls provide better hygiene and a reduction in hoof diseases. The reduction of sole ulcers and heel horn erosions in herds with feed stalls could be explained by a cleaner and more comfortable foot environment. Feed stalls also give better conditions for first-calving heifers to defend a chosen position during feeding without being displaced. Furthermore, automatic scrapers can be used continuously without disturbing the eating animals, resulting in a cleaner environment than when scraping can be done only at milking, 2–3 times daily.

See Figures 6-13–6-16.

## Floor Properties

### KEY CONCEPT

- Some workers believe that the effect of flooring surfaces in cow barns is as equally important as is nutritional management.

Concrete floors are directly associated with claw lesions. The hardness, the friction that determines abrasiveness and slipperiness, and hygiene of floor surfaces are factors affecting the health of feet and legs.



**Figure 6-13** The central alley of this Swedish barn has a rubber floor and a mechanical scraper which ploughs both ways. Note that the back of the stall is fitted with slats which are also covered with rubber. (Courtesy of C Bergsten)



**Figure 6-14** An individual feeding stall with rubber mats and a short partition. (Courtesy of C Bergsten)



**Figure 6-15** The main alley in this barn has a slatted floor. The feed bunks here are separated by a partition and the floor of the standing area is covered with a rubber mat. This system reduces competition for bunk space. (Courtesy of C Bergsten)



**Figure 6-16** A spacious barn with a central feed truck alley between two rows of feed stalls with individual stall partitions and rubber flooring. (Courtesy of C Bergsten)

In Europe, there is a rapid and successful development of rubber coating for both continuous and slatted flooring. Rubber floors wear claw horn less than abrasive concrete.

Mastic asphalt flooring with its higher friction is associated with more efficient gait and will maintain its high friction qualities permanently. However, there is a risk that mastic asphalt flooring can cause overwear.

### TECHNICAL COMMENTS

Friction can be measured in different ways but no values can fully describe the biology and the biomechanical interaction of the foot with the floor. The smoothness of concrete is measured as the coefficient of static friction expressed as 'mu.' The optimal mu value appears to be between 0.4 and 0.5 and is the range on which cows are willing to walk freely. Higher values increase the rate of wear of the sole horn. The mu value is determined by the size, shape, and hardness of the aggregate used in the concrete. The mu value of the solear surface of the claw increases after trimming. The coefficient of friction of the claw is much greater in a forward and backwards direction than it is from side to side. This finding accounts to some extent for lateral slippage which has been proposed as a contributing factor to overburdening of the lateral hind claw, which in turn causes the 'cow hock' posture.

Concrete is the least expensive and most practical material used for the preparation of surfaces in dairy barns, therefore, it is the most common floor surface used. New (green) concrete usually causes an increase in the prevalence of lameness for up to 9 months after it has been laid. The reason for this is not clear, but both the physical characteristics of abrasiveness as well as the chemical properties of new concrete and surface pH have been proposed as contributing causes. It is recommended that fresh concrete should be treated with cold asphalt and sawdust as a softener until the sharp layers of the concrete have worn away.

The 'grip' of concrete decreases and, as it ages, it becomes too slippery. The rate of deterioration is reduced by using higher density concrete, concrete additions, and providing longer 'after-treatment.' The friction of the floor is a compromise between too much wear of the claws and the risk for accidents due to slipping. Mastic asphalt surfaces are marginally softer than concrete, are acid resistant, and will not become smoother with time.

Increased step length is a positive sign of cow locomotion comfort. On slippery floors, cows walk with wider and frequent short steps. On high-friction floors, the animals walk with longer strides.

Soft elastic flooring for paved walking areas is available and claimed to be beneficial to claw health. It is expensive but can be a worthwhile investment by reducing culling due to lameness.

Long-term Swedish studies show that growth of solear horn is reduced on soft floors. Furthermore, the wear of solear horn is less on older, less abrasive, concrete flooring, making the net growth equal to that of rubber floors. Mastic asphalt showed the highest growth and wear rates and balanced net growth. When feed stalls equipped with rubber mats were added to the mastic asphalt flooring, the net growth was positive. The results show that a compromise between different types of flooring – abrasive, skid resistant, and soft – can be beneficial.

High cow population densities, more frequent milking, longer feeding time, and greater walking distance back and forth to the facilities on concrete floors can be contributing factors for excessive wear and overburdening of the hooves. There are also large variations due to the individual behavior of each animal. During estrus, toes can rapidly wear down when cows are riding on an abrasive floor.

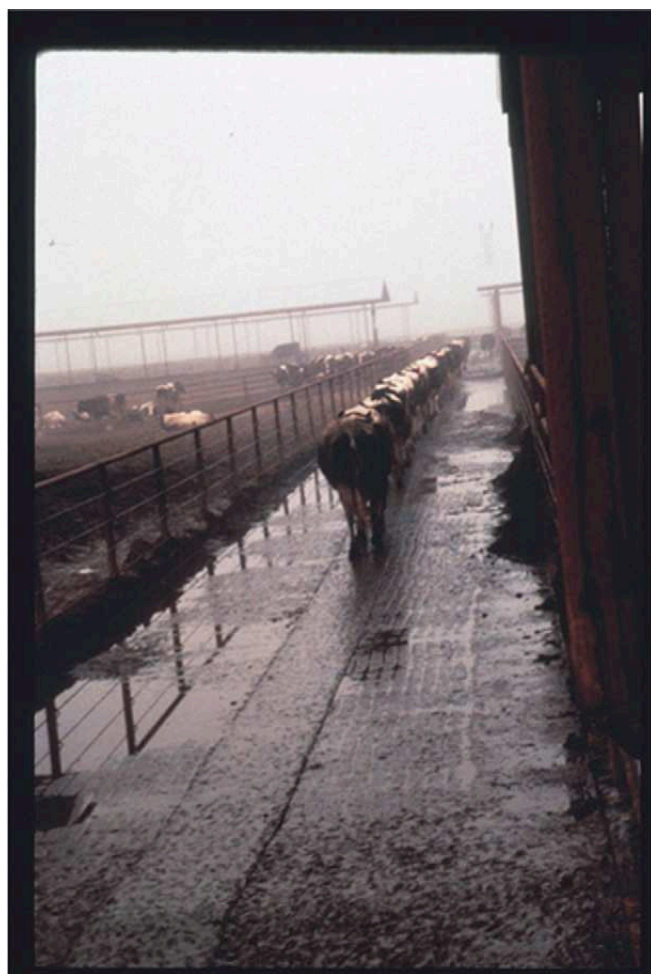
See Figures 6-17 and 6-18.

### **Acclimatization to Concrete Floors**

Cows that have been maintained on soft surfaces during the dry period, and then suddenly exposed to concrete at calving have a higher incidence of lameness than those



**Figure 6-17** Here cows can be seen choosing to walk on a rubber mat in single file. However, confrontation disturbs the smooth flow. (Courtesy of G Jones)



**Figure 6-18** If given the opportunity cows prefer to walk single file on a narrow rubber mat than on a concrete road. (Courtesy of K Burgi)



that are gradually acclimatized to walking on concrete. It is, therefore, recommended to make changes from softer to harder surfaces at least 1 month before calving. This is especially important for heifers. Keeping heifers on deep straw pack or grazed on soft pastures just before introduction to a concrete milking stall can cause great problems with lameness. An alternative is to keep animals on soft ground or a straw yard until a few weeks after calving before introducing them to concrete floors.

### Profiling Floors

The grip of concrete can be improved by 'profiling' the surface of the concrete by harrowing (roughening the surface by dragging a heavy object over the wet concrete or profile rolling the fresh concrete to produce a pattern of grooves). It is strongly recommended that profiling is carried out by experienced professionals. It has been found that 11% of cows 'skid' on floors with a profile whereas 56% of cows have been found to skid on unprofiled floors. Concrete surfaces must be provided with grooves 1cm (0.75ins) deep. The direction of the grooves must either be in a diamond pattern or run across the line of the animal's progression. Locomotion studies have shown that rubber mats showed the best results – the softness of the rubber gives a grip into the surface and reduces slipperiness.

---

## HYGIENE AND BARN MANAGEMENT

Cows avoid manure-covered floors in preference for those that are dry, wet or consist of earth (dirt). Cows that lie for long periods will be exposed to slurry for a shorter period. This in turn would reduce the environmental challenge to the foot as well as reducing the likelihood of falls on slippery concrete surfaces.

Good hygiene is essential to reduce the incidence of infectious diseases. Slurry contains a mixture of organisms and chemicals, many of which can attack the horn of the claw or the skin between the claws. Excessive moisture in the environment softens the horn, which then wears more rapidly and is more prone to mechanical damage. Moisture also macerates the interdigital skin, which exposes deeper tissues to attack by microorganisms. At pasture, mud in gateways and around drinking troughs serves as a reservoir of infection. Environmental moisture can be absorbed by the claw horn.

Epidemiological studies from France and California reveal that the most significant risk factor for heel horn erosion and papillomatous digital dermatitis, respectively, is unhygienic conditions. It is thus clearly documented that a more or less permanently, manure-contaminated environment predisposes for infectious foot diseases.

In a Swedish study, the prevalence and severity of heel horn erosions associated with interdigital dermatitis were significantly higher in the group with dirtier stalls. The moisture content of the sole horn was positively correlated to the severity of heel horn erosions.

Mechanical scraping is effective but expensive to install. It is prone to mechanical failure and can cause injury to cows standing in the gutter. The system has the advantage that the barn can be cleaned several times daily.

Tractor scraping is labor intensive and can only be carried out when the cows are out of the barn or physically restrained in their stall or feed bunk.

Flushing can usually only be installed in new buildings. Although it is a labor-saving system, the volume of water used is considerable. The use of a holding/sedimentation tank economizes on the use of water but increases the risk of spreading slurry-borne diseases. It is recommended that curb heights be raised by 5cm (2ins) to 20cm (8ins) plus the thickness of the bedding in order to prevent the rush of water overflowing onto the surface of the stall.

Alleys must be scraped or flushed at least twice each day.

Drainage gutters are sometimes located adjacent to the curb. If the slopes are sufficient, this feature will reduce the amount of liquid in the alleyways. Covering gutters with steel grating is usually recommended.

### Slatted Floors

- Scrapers on top of the slatted floor improve hygiene and are becoming more popular in Europe. Scrapers can also be used on top of rubber slats.
- Rubber coated slatted floors improve cow comfort.
- Slatted floors normally stay cleaner than solid floors.
- Poor drainage of slatted floors can, however, occur when there are too few cows to move the manure through the slots or when there is too much litter or feed on the floor.
- Concrete slatted floors have the same disadvantages as solid concrete floors regarding hardness, abrasiveness, and slipperiness with time.
- Cows prefer not to walk on slatted floors unless they are covered with rubber.

### Ventilation of the Barn

- Ventilation controls the removal of moisture from the bedding as well as the extraction of carbon dioxide and ammonia. Heat stress and subnormal temperatures must be accounted for when the building is designed.



**Figure 6-19** In tropical climates (such as this yard for dairy cows in Israel) barns have high roofs, cooling fans and in some cases water sprays to help lower the body temperature of the cows.

- The ridge should be open. Depending on the climate, opening sidewalls or windows should be provided.
- A direct flow of air over the bedded area is highly desirable to keep the bedding dry and control the numbers of bacteria.

See Figure 6-19.

## Noise

Sudden and loud noises stress cattle. Soft music can drown out the clatter and machine din in a milking parlor.

## The Skill of the Animal Attendant

Farmers seriously underestimate the incidence of lameness (by 16.38%). Early recognition of lameness is pivotal to early treatment. Early treatment is critical to avoid suffering and reduce economic loss through reduction of lactation milk yield.

Low farmer skills, knowledge, and awareness about cattle lameness have been related directly to foot problems in dairy herds. Farmers who take courses or who attend claw-trimming training sessions are known to have better control of lameness among their animals.

On a small farm, one person may be responsible for the day-to-day management of animals as well as exercising the skills needed for the long-term management of the farm. In large dairy units, the producer has the oppor-

tunity to assemble a specialized consulting unit consisting of the veterinarian, livestock specialist nutritionist, and claw trimmer.

## BIBLIOGRAPHY

- Benz B, Wandel H 2004 Soft-elastic flooring for paved walking areas in cubicle housing systems for dairy cattle. *Proceedings of the XIIIth International Symposium on Lameness in Ruminants, Maribor*, p 212–213
- Bergsten C, Frank B 1996 Sole haemorrhages in tied primiparous cows as an indicator of periparturient laminitis: the effects of diet, flooring and season. *Acta Veterinaria Scandinavica* 37:383–394
- Bergsten C, Herlin A 1996 Sole haemorrhages and heel horn erosion in dairy cows: the influence of housing systems on their prevalence and severity. *Acta Veterinaria Scandinavica* 37:395–408
- Bergsten C 2001 Effects of conformation and management system on hoof and leg diseases and lameness in dairy cows. In: Anderson D (ed) *Veterinary Clinics of North America: Food Animal Practice, Volume 17*. W B Saunders, Philadelphia, p 1–23
- Bergsten C 2004 Healthy feet requires cow comfort 24 hours. *Proceedings of the 13th Symposium on Lameness in Ruminants, Maribor*, p 186–191
- Bergsten C, Hultgren J 2002 Effects of a rubber-slat system on cleanliness, foot health, and behaviour in tied dairy cows. *Proceedings of the XIIth International Symposium on Lameness in Ruminants, Orlando*, p 284–286
- Bergsten C, Telezhenko E 2005 Walking comfort of dairy cows in different flooring systems expressed by foot prints and preference. *Proceedings of the British Cattle Veterinary Association Conference, Torquay*, p 121–126
- Bickert W G, Stowell R R 1993 Design and operation of natural ventilation systems in dairy free stall barns. *Proceedings of the IVth International Livestock Environment Symposium, Coventry*
- Bickert W G 1994 Designing dairy facilities to assist in management and to enhance animal environment. *Proceeding of the IIIrd International Dairy Housing Conference, Orlando*
- Britt J 1993 What is your cow comfort index? *Dairy Herd Management* 19:39
- Chaplin S J, Tierney H E, Stockwell C 1999 An evaluation of mattresses and mats in two dairy units. *Applied Animal Behaviour Science* 66:263–272
- Colam-Ainsworth P, Lunn G A, Thomas R C et al 1989 Behaviour of cows in cubicles and its possible relationship with laminitis in replacement dairy heifers. *Veterinary Record* 125:573–575
- Cook N B 2004 Lameness prevalence and effect of housing on 30 Wisconsin dairy herds. *Proceedings of the XIIth International Symposium on Lameness in Ruminants, Orlando*, p 325–326
- Cermák J 1990 Notes on welfare of dairy cows with reference to spatial and comfort aspects of design of cubicles. *Proceedings of the VIth International Symposium on Diseases of Ruminant Digit, Liverpool*, p 85–90

- Dumelow J, Albutt R 1990 The effects of floor design on skid resistance in dairy cattle buildings. Proceedings of the VIth International Symposium on Diseases of the Ruminant Digit, Liverpool, p 130–134
- Galindo F, Broom D M 1993 The relationships between social behaviour of dairy cows and the occurrence of lameness. Cattle Practice, British Cattle Veterinary Association 1:360–365
- Haley D B, Pasille A M de, Rushen J 2001 Assessing cow comfort: effects of two floor types and two tie stall designs on the behaviour of lactating dairy cows. Applied Animal Behaviour Science 71(2):105–117
- Haley D B, Pasille A M de, Rushen J 2000 Behavioural indicators of cow comfort: activity and resting behaviour of dairy cows in two types of housing. Canadian Journal of Animal Science 80(2):257–263
- Kremer P, Nuske A, Scholtz M 2004 Influence of different floor conditions on claw development, metabolism and milk yield in dairy cows housed in stalls with free cow traffic. Proceedings of the XIIIth International Symposium on Lameness in Ruminants, Maribor, p 210–212
- Laven R A, Livesey C 2004 The influence of rearing environment on the behaviour of heifers in cubicles. Proceedings of the XIIIth International Symposium on Lameness in Ruminants, Maribor, p 204–206
- Lendelova J, Pogran S 2003 Thermo-technical evaluation of rubber and wooden floor structures for lying cubicles. Acta Technologica Agriculturae 6(4):105–109
- Leonard F C, O'Connell J, O'Farrell K 1994 Effect of different housing conditions on behaviour and foot lesions in Friesian heifers. Veterinary Record 134:490–494
- Logue D N, Offer J E, Brockelhurst S, Mason C 2004 Effect of training dairy heifers to use cubicles before first calving on subsequent behaviour and hoof health. Proceedings of the XIIIth International Symposium on Lameness in Ruminants, Maribor, p 191–193
- Manske T, Hultgren J, Bergsten C 2002 Prevalence and interrelationships of hoof lesions and lameness in Swedish dairy cows. Preventive Veterinary Medicine 54:247–263
- Marten F, Wolf J 1999 Effect of different mats on resting time of dairy cows. Milchpraxis 37(2):90–94
- Miller K, Wood-Gush D G M 1991 Some effects of housing on the social behaviour of dairy cows. Animal Production 53:271–177
- Nilsson C, Svennersted B 2000 Draining rubber floors for cattle – design, behaviour and draining capacity. Specialmeddelane Institutionen for Jordbrikets Biosystem och Teknolo Sveriges Lantbruksuniversitet No 234:40
- O'Connell J, Giller P S, Meaney W 1989 A comparison of dairy cattle behavioural patterns at pasture and during confinement. Irish Journal of Agricultural Research 28:65–72
- Phillips C J C, Chiy P C, Bucktrout M J 2000 Frictional properties of cattle hooves and their conformation after trimming. Veterinary Record 146:607–609
- Phillips C J C, Morris T D 2000 The locomotion of dairy cows on concrete floors that are dry, wet or covered with a slurry of excreta. Journal of Dairy Science 83(8):1767–1772
- Phillips C J C, Morris I D 2002 The ability of cattle to distinguish between, and their preferences for, floors with different levels of friction, and their avoidance of floor contaminated with excreta. Animal Welfare 11(1):21–29
- Phillips C J C, Rind M I 2001 The effects on production and behaviour of mixing uniparous and multiparous cows. Journal of Dairy Science 84:2424–2429
- Phillips C J C, Morris I D 2001 The locomotion of dairy cows on floor surfaces with different frictional properties. Journal of Dairy Science 84(3):623–628
- Swierstra D, Braam C R 1999 Grooved floor system for cattle housing: ammonia emission reduction and good resistance. American Society of Agricultural Engineers. Proceedings of Annual International Meeting, Toronto, p 18–21
- Singh S S, Ward W R, Lautenbach K et al 1993 Behaviour of first lactation and adult dairy cows while housed and at pasture and its relationship with sole lesions. Veterinary Record 133:469–474
- Singh S S, Ward W R, Lautenbach K 1993 Behaviour of lame and normal dairy cows in cubicles and in a straw yard. Veterinary Record 133:204–208
- Telezhenko E, Bergsten C, Magnusson M 2004 Swedish Holsteins' locomotion on five different solid floors. Proceedings of the XIIth Symposium on Disorders of the Ruminant Digit, Maribor, p 164–165
- Telezhenko E, Bergsten C, Magnusson M, Ventorp M, Hultgren J, Nilsson C 2005 On the development of asymmetry between lateral and medial rear claws in dairy cows. Proceedings of the European Association of Animal Production, Rome, p 175
- Ward W R 1994 The role of stockmanship in foot lameness in UK dairy cattle. In: Proceedings VIII International Symposium on Disorders of the Ruminant Digit, Banff, p 301
- Webster A F J 2002 Effects of housing practice at calving and in early lactation on the development of sole and white lesions in dairy heifers. Proceedings of the XIIth International Symposium on Lameness in Ruminants, Orlando, p 298–301
- Wierenga H K 1986 The social behaviour of dairy cows: some differences between pasture and cubicle system. In: Unshelm J, Putten G van, Zeeb K (eds) Proceedings of the International Congress on Applied Ethology of Farm Animals, p135–138

## Disorders of the Claw Capsule Associated with Laminitis

### KEY CONCEPTS

- Each of the disorders described in this chapter has a high incidence in herds in which subclinical laminitis is known to be present. Conversely, the presence of subclinical laminitis as a herd problem can be confirmed if the incidence of these disorders is collectively greater than 10%.
- However, many of these disorders can also have an etiology that is not associated with subclinical laminitis.

### SOLE ULCER (PODODERMATITIS SEPTICA CIRCUMSCRIPTA)

#### KEY CONCEPT

- Sole ulcers are a raw or granulating area about 1 cm in diameter located in zone 4, usually in the lateral hind claw.

### Description

With this disorder, the progress and severity of lameness are variable.

When both lateral hind claws are affected, lameness is not easily detected, as pain in one foot tends to balance the pain in the other.

In tie stalls, the hind toes may be rested on the edge of the curb of the stall in an attempt to relieve pain.

On flat surfaces, an affected animal will stand with the hindlimbs camped back.

Some cows may shake the affected foot frequently.

When both hind feet are affected, the cow may continually shift weight from limb to limb and frequently lie down.

A sole ulcer can be concealed below a layer of horn which may be discolored.

Clinically, it is possible to distinguish between an open and closed ulcer. If the cow does not react to pressure on the discolored area of the sole, the lesion should be considered closed; in other words, it has not reached a point at which preventive treatment is likely to be unsuccessful. If the lesion responds to pressure, it should be considered as being open and loose horn will have to be removed.

See Figures 7-1–7-5.



**Figure 7-1** A typical sole ulcer is located in zone 3 at the junction of the heel and sole. This is referred to as the 'typical place.' In appearance the ulcer is said to resemble a strawberry.



**Figure 7-2** The first sign of a sole ulcer may be a hemorrhage over the typical site.



**Figure 7-3** Sometimes an ulcer is not discovered until superficial layers of sole horn are pared away. (Courtesy of C Bergsten)



**Figure 7-4** If sole ulcers are neglected, infection will cause damage to the flexor tendon, spread up the tendon sheath, and/or cause serious infection of the pedal joint. (Courtesy of C Bergsten)



**Figure 7-5** Rupture of the flexor tendon leads to dorsal rotation (upwards) of the toe ('cocked toe'). Lack of wear under a cocked up toe will eventually cause overgrowth and a significant deformity will result (see Fig. 17-49, p. 263).

## Cause

### KEY CONCEPTS

- A sole ulcer is caused by pressure that crushes and destroys dermal tissues in a very specific region of the sole.
- Sole ulcers are frequently associated with subclinical laminitis.

A sole ulcer is caused by pressure which crushes and destroys horn-producing tissues between the flexor process of the pedal bone and the inside of the sole. Horn production then ceases over a very small 'circumscribed' area. This, in turn, causes a hole to develop in the sole through which granulation tissue (proud flesh) will protrude.

### The Role of Subclinical Laminitis

Subclinical laminitis (SCL) is associated with the production of softer-than-normal horn. When this happens, the sole of the claw wears more rapidly than normal. Consequently, the sole is thinner and flatter than normal, making the 'typical place' prone to trauma.

Laminitis also leads to damage of the suspensory apparatus of the digita and support system of the pedal bone with subsequent displacement (sinking/rotation) of the pedal bone. This may account for slight variations in the location at which the pedal bone sinks. As a result there is a broad variety of ulcers of different size and located at slightly different sites.

### Other causes

Horn overgrowth is a common finding accompanying many claw diseases. It is not uncommon to see sole ulcers in neglected (very) long claws. In these cases, the abnormal shape of the claw shifts the load axially and backwards. This leads to a localized compression by the flexor process of the digital cushion and dermis against the inner surface of the sole.

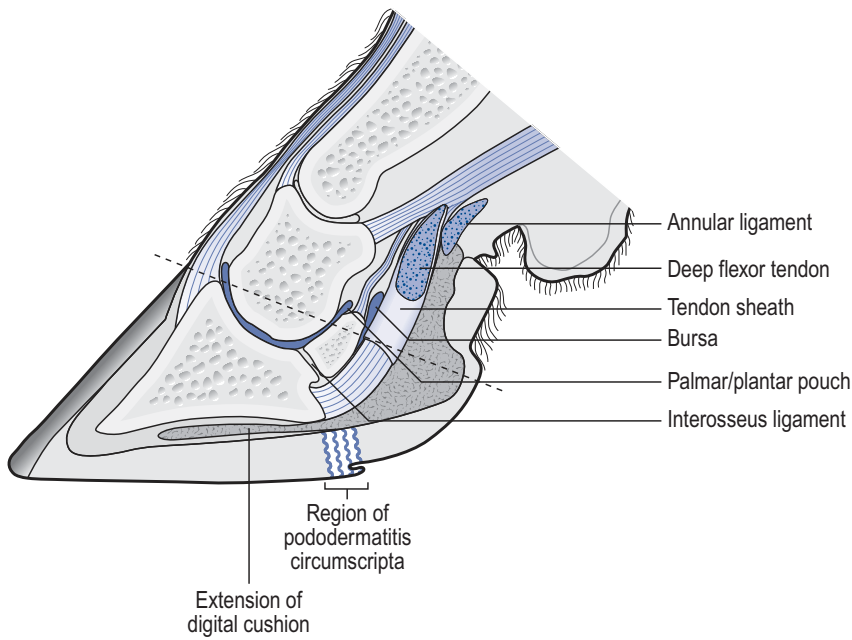
Often it is difficult to distinguish between cause and effect. For example, a cow may seek relief from bearing weight on an established ulcer which will permit accelerated growth of the posterior, abaxial wall and bulb. This adds to the load borne by the claw and to the discomfort of the patient.

Sole ulcers can be a result of claw trimming if the operator is inexperienced. Producers should be discouraged from attempting to correct this disorder themselves.

A thin sole is not necessarily involved in the pathogenesis of an ulcer. Alteration of the pedal bone (formations of exostosis) was suggested as a possible etiology by Rusterholz (1920) who was the first to propose that the disorder develops from inside.

In complicated cases, infection may even travel up the deep flexor tendon sheath.

See Figures 7-6–7-10.



**Figure 7-6** A sole ulcer is caused by mechanical pressure on the corium between the flexor process of the distal phalanx and the sole. The usual reason for this pressure is that the sole is abnormally thin due to accelerated wear or over-trimming. The softer horn associated with laminitis is believed to be a contributory factor.



**Figure 7-7** The flexor process (FP) of the pedal bone is located directly above zone 4, which is the typical place at which ulcers are found on the sole. (Courtesy of C K W Mülling)



**Figure 7-8** Pressure necrosis at the site of mechanical pressure destroys the germinal layers of the corium. No horn is produced and a hole appears in the sole through which granulation tissue will emerge. A sole ulcer therefore grows from the inside outwards. (Courtesy of P Ossent)



Figure 7-9 In rare cases horn will detach from the sole and slip over the 'typical place' causing abnormal pressure on the flexor process.



Figure 7-10 Heel erosion can be a contributing factor. Loss of heel horn causes weight to be shifted forward to the typical site of a sole ulcer.

## Treatment

### KEY CONCEPTS

- Treatment must be aimed at trimming the sole to remove pressure from the affected digit.
- Alternatively a 'lift' should be fixed to the ipsilateral (other) claw.
- Never bandage a sole ulcer. A bandage increases pressure on the affected site. It also acts like a wick, increasing moisture around the lesion, thus slowing healing.

Cauterization or treatment with any caustic agent should be avoided. If the granulation tissue protrudes beyond the surface of the sole, it should only be removed to the level of surrounding tissue. This encourages the cells of the living epidermis to invade the surface of the granulated area from the periphery. In complicated cases, depending on the depth of destruction, the lesion will need protection. This can be provided by a plastic bag held in position with duct tape. The purpose is to avoid increasing pressure on the lesion itself.

### Therapeutic Claw Trimming

Only in skilled hands is therapeutic claw trimming highly effective. This procedure lowers the entire bearing surface of the affected claw, transferring weight-bearing to the sound medial claw.

### Applying a Lift

### GLOSSARY

**A Lift:** This is a device that is placed beneath a sound claw to elevate the ipsilateral (opposite) claw in order to prevent a lesion touching the ground. A lift may take the form of a block of wood or rubber or a slipper or shoe (for more information see p. 195).

It is usually necessary to slightly trim the claw to provide a sound surface before a 'lift' is applied. Lifts may remain in place for 4 weeks, after which time they must be removed.



Recently, shoes or slippers are proving to be a popular type of lift. The devices are blocks of hard plastic shaped in the form of a sole to which a slipper-like upper has been fixed. The upper provides a convenient receptacle in which an adhesive can be mixed. In some cases, the trailing edge of a shoe (lift) may cause pressure on the sole which can eventually cause lameness. When lameness is observed to increase, the lift should be removed immediately and the claws re-examined.

## WHITE LINE DISEASE

### KEY CONCEPTS

- White line disease is the most common complication associated with subclinical laminitis.
- The appearance of a foot with a retroarticular abscess is often confused with foot rot. With foot rot, the whole foot is swollen, necrosis is present between the claws, and there is a typical foul odor. A retroarticular abscess only causes swelling of one digit.

## Description

White line lesion is a general term used to describe disintegration of the white line in zone 3, together with any purulent complication of that lesion.

The lateral claw of the hind foot (often both) is usually involved. However, if both hind feet are affected, lameness may appear to be only slight. As in the case of a sole ulcer, pain in one foot tends to balance that in the other, thereby masking the severity of the discomfort.

As the animal walks, the affected limb will be swung away from the body during each stride. The animal may stand with the medial claw bearing weight.

White line separation without complications is frequently seen at claw trimming. It is only when an abscess develops in the angle between the wall and the sole that the animal will become lame. When lameness is not observed and/or treatment is not given, several different clinical scenarios may be presented:

1. Pus may be found oozing from the skin/horn junction on the abaxial side of the coronary band. A black mark may be observed somewhere in the white line in zone 3. In this case, there will be a strong possibility of a track running under the wall from the white line to the coronary band. This probability can be confirmed by removing a small amount of wall at the bearing surface adjacent to the white line lesion (see Figs 7-25 and 7-26).
2. The skin above the coronary band may be tender, puffy, and inflamed. This strongly indicates that the pedal joint is infected. Radiology is usually helpful in confirming this diagnosis (see Chapter 17, p. 253).
3. Involvement of the region behind the pedal joint (retroarticular region) should be suspected if there is marked tenderness, swelling, and erythema in the region above the coronary band at the heel bulb. There may be a sudden increase in the severity of lameness. Infection of the pedal joint itself is more likely to cause swelling of the skin above the coronary band closer to the dorsal surface. Radiographic examination of the pedal joint (p. 253) is indicated.

The build-up of pus in the retroarticular space can be confirmed by inserting a hypodermic needle and drawing the material into a syringe. The size of the abscess increases continuously, causing the surrounding tissues to suffer considerable damage. The main diagnostic clue is a slight increase in the size of one heel bulb compared with the other. Gas is sometimes observed in a radiograph.

See Figures 7-11–7-23.

## Cause

### KEY CONCEPT

- The loss of mechanical homeostasis inside the claw capsule (loss of balance between forces) causes rupture at the white line.



**Figure 7-11** This is a bruised, worn sole. Pressure on the white line in zone 3 has created spaces corresponding to the ends of the lamellae. It is possible that infection could travel inwards following the tiny spaces. (Courtesy of J Malmo)



**Figure 7-13** The wall splits from the sole. The clinical sign may be extremely slight. The swelling indicated by the finger suggests the presence of a deep seated abscess. (Courtesy of J Malmo)



**Figure 7-12** The earliest sign is a distinct hemorrhage in the white line. (Courtesy of J Naylor)



**Figure 7-14** Once superficial horn is removed pus is released. If the lesion is not detected early a destructive retroarticular abscess will be the likely result. (Courtesy of J Malmo)

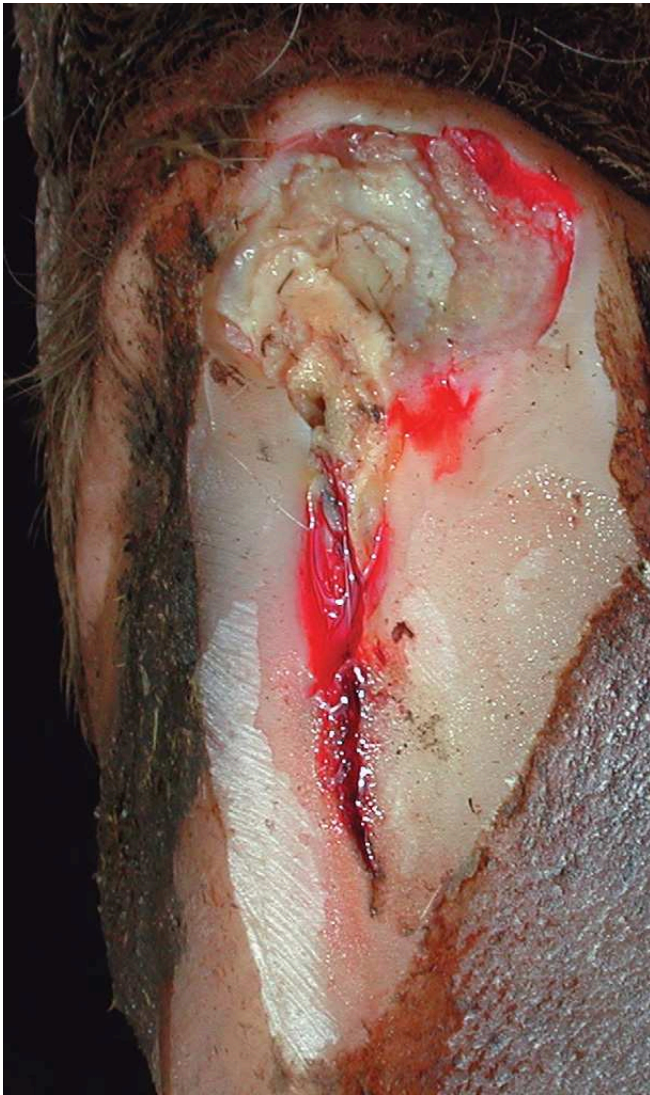


Figure 7-15 The same lesion as shown in Figures 7-13 and 7-14 with the extent of the lesion exposed. Note that the pus is extending to and escaping from the skin/horn junction above the heel bulb. (Courtesy of J Malmo)



Figure 7-16 This case is similar to the last except that the lesion is now 'open' and starting to accumulate foreign bodies. (Courtesy of J Malmo)



Figure 7-17 It is surprising how many small stones have become impacted in this defect. (Courtesy of J Malmo)

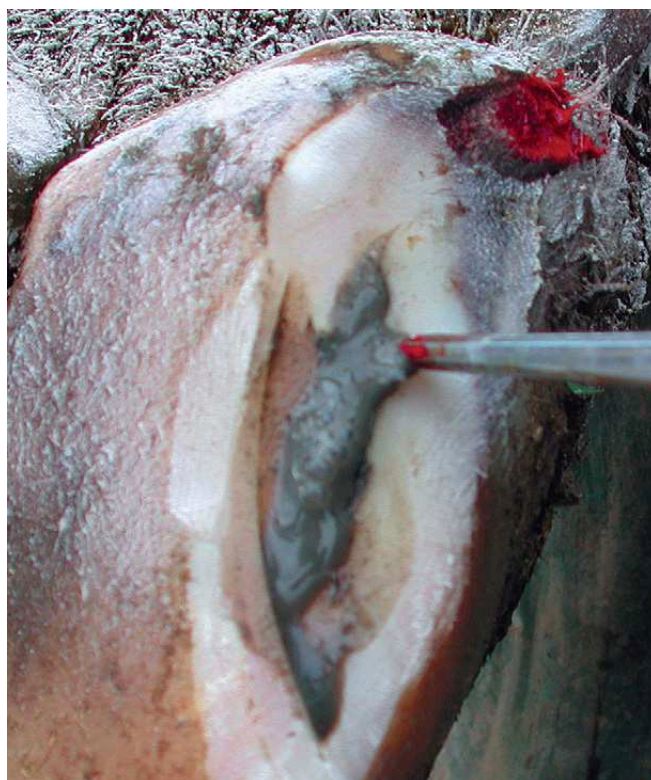


Figure 7-19 As the wound is opened still further necrotic tissue can be removed. (Courtesy of J Malmo)



Figure 7-18 The pus escaping from this wound is black in color. This is typical when infection enters a foot from the environment. (Courtesy of J Malmo)



Figure 7-20 In the two cases presented (Figs 7-13 to 7-15 and 7-16 to 7-19) the tracking has moved upwards and backwards to seek release above the bulb of the heel. The picture shown here is a claw that has not been treated but separation of the heel horn has occurred. (Courtesy of J Malmo)



**Figure 7-21** Hemorrhage in the sole suggests this case may have had an origin associated with subclinical laminitis. It appears that the impact of locomotion gradually increased the size of white line rupture to permit the entry of a foreign body. (Courtesy of J Malmo)



**Figure 7-23** The abaxial wall eventually becomes completely detached from the corium. A sinus beneath leads to a retroarticular abscess via the navicular bursa. Swelling of the region above the skin/horn margin of the heel (bulb) is always suspicious of a retroarticular abscess (p. 261). The unilateral swelling of one heel bulb is frequently misdiagnosed as being a case of foot rot.



**Figure 7-22** As the white line opens foreign bodies become impacted and with them infection is carried into the dermis. In this case a traumatic 'open' etiology may have occurred. (Courtesy of J Malmo)

### **Factors Associated with Normal Features of Structure and Function**

The first impact of each stride is greatest at the heel/sole junction (zones 3 and 4). The digital cushion expands sideways when it is compressed under weight-bearing. Sideways expansion of the digital cushion causes pressure to be exerted on the wall above zone 3.

The abaxial end of the white line in zone 3 is the broadest part of the white line (width up to 5mm). Additionally, the softest horn of all areas of the white line is in this zone.

The highest rate of horn production occurs in the abaxial wall above zone 3. It is also believed that in this region the white line is particularly susceptible to alterations of the vascular system and subsequent disruption of nutrition.

### **Factors Associated with Failure of the Normal Anticoncussion Systems**

Subclinical laminitis may cause stretching of the collagen fibres off all of the structures inside the claw capsule. Aging of the digital cushion reduces its anticoncussive capacity.

As a complication of subclinical laminitis, the quality of wall horn is reduced – certainly in the long term. Furthermore, changes in the shape of the capsule, from whatever cause, reduce the tensile strength of the wall.

When the sole flattens, loading is altered or shape is changed. Disturbance in the distribution of weight-bearing forces inside the claw will follow.

### TECHNICAL COMMENTS

The pathogenesis of white line disease has never been demonstrated conclusively. The information available has been extrapolated from observations made by individuals with considerable experience in attending to disorders of the claw capsule. It is postulated that there are two possible pathologies:

*The closed hypothesis* is suggested because large lesions (Figs 7-13, 7-14 and 7-15) may be encountered during routine claw trimming and in which a track through the white line in zone 3 is minimal if such lesions start inside the capsule. They do so posterior to the abaxial groove where the lamellae are not present. This suggests that the suspensory apparatus of the digit is not involved. Nevertheless, the fibrous tissues of the support system of the pedal bone (see p. 20) could be affected by matrix metalloproteinases (MMPs) and this could result in lateral pressure on the abaxial wall. In this way the white line could be torn open from the inside.

*The open hypothesis* is based on the observation that most of the lesions causing lameness are of this type. The white line in zone 3 is wide open and frequently packed with debris (Figs 7-21 and 7-22). As deep tissues are exposed, pus is released. When purulent material is black in color, it is a probable indication that infection has entered the foot from outside.

In all likelihood, both types of pathologies are involved to a greater or lesser extent. In any case, infection tends to track backwards and finds release at the skin/horn junction above the heel bulb (Fig. 7-20). The outcome can be variable depending on the location of the abscess.

See Figure 7-24.



Figure 7-24 In this picture the track from the white line to the coronary band has caused considerable damage. (Courtesy of P Ossent)

### Treatment

#### KEY CONCEPT

- ALWAYS cut out and follow black spots in the white line as far as they extend in or under the wall by removing elliptical slices of wall.

The treatment of white line disease depends on the stage of severity to which this disorder has progressed. That is to say, the disorder may be presented at any of the following stages:

- An uncomplicated black mark* anywhere along the white line in zone 3. An elliptical slice of adjacent wall should be removed to establish a self-cleansing surface (Fig 7-27).
- A local abscess* extending from a black mark in the white line. The opening must be made of size adequate to ensure drainage. Removal of an elliptical slice of wall will provide a self-cleansing surface. Once opened and drained, a cavity caused by the abscess will be revealed. It may be helpful to inject a liquid antibiotic into the cavity and then cover the opening with a waterproof adhesive bandage. The opening to the cavity needs only to be covered for a few hours as the space inside fills very rapidly.
- A track* may extend upwards and backwards from the white line. For the first 2.5cm (1in), the track may be followed by removing overlying wall. Beyond this distance, destruction of the wall can be reduced by cutting a channel with the blade



**Figure 7-25** Infection may be forced along the spaces between the lamellae (p. 89) to form a track. An elliptical incision has been made to remove wall to expose tracks. This procedure has to be considered as a very important measure not only in the treatment but also in the prevention of the complication of white line (closed) defects. Lacking the side wall, penetration of foreign objects in the white line defects, and consequent development of an abscess, will become almost impossible. (Courtesy of A Brizzi)



**Figure 7-26** In this case an elliptical cut has been made, exposing a more marked destruction of the dermal/epidermal junction. (Courtesy of A Brizzi)



**Figure 7-27** If the lesion in the white line is small or a local abscess is opened in the white line an elliptical slice of wall should be removed to form a self-cleansing surface. (Courtesy of A Brizzi)

of a 'Dremmel Tool.' This is the method of choice if pus is being discharged from around the coronary band (see Fig. 16-21).

- (d) *Septic arthritis of the pedal joint* and a *retroarticular abscess* are complications which cause swelling, inflammation, and tenderness of the skin above the coronary band. They are considered in more detail on pages 252–263.

The application of a 'lift' is mandatory for the treatment of all complicated lesions of the claws.

See Figures 7-25–7-27.

## TOE ULCER

### KEY CONCEPTS

- A toe ulcer affects mature cows. A toe abscess affects only beef yearlings. See Figure 7-28.
- The similarity between the appearances of these two conditions is quite remarkable. It is quite likely that some factors are common to both disorders.

**Description**

A mature cow affected with a toe ulcer will become progressively lame as the severity of the lesion advances. There will be a tendency for the animal to stride slightly forward (camp forward) on one or both feet.

Usually, toe ulcers do not affect heifers during their first lactation. However, in recent years, many heifers in Uruguay have been reported with this condition. It should be noted that this observation coincides with heavy feeding of concentrates in pastured animals.

The lesion starts as a slight hemorrhage in the white line in zone 1. In some cases, the horn in the sole around the initial lesion becomes stained with blood. In other cases, a yellow exudation of serum occurs.

Toe ulcers in cows are seen mostly in animals housed in free stalls, although it has been observed in cows housed in dry lots. It is most commonly present in

herds in which subclinical laminitis is known to be a problem.

A precipitating factor appears to be over-wear of the toe (e.g., cows housed on slatted concrete floors). After some time, the animal refuses to bear weight on the apex of the claw. This results in an overgrown toe region with the weight being borne mainly by the bulbar region.

In extreme cases, the apex of the pedal bone will prolapse through the sole, producing a lesion reminiscent of the lesion that affects horses with acute laminitis.

Extensive damage of the dorsal wall of the claw, an occasional sequel to digital dermatitis, has also been seen to be associated with toe ulcers.

Not all lesions in the white line of zone 1 in mature cows can be classified as toe abscesses. Traumatic lesions can also be detected by applying physical pressure to the toe region with calipers.

See Figures 7-29–7-33.

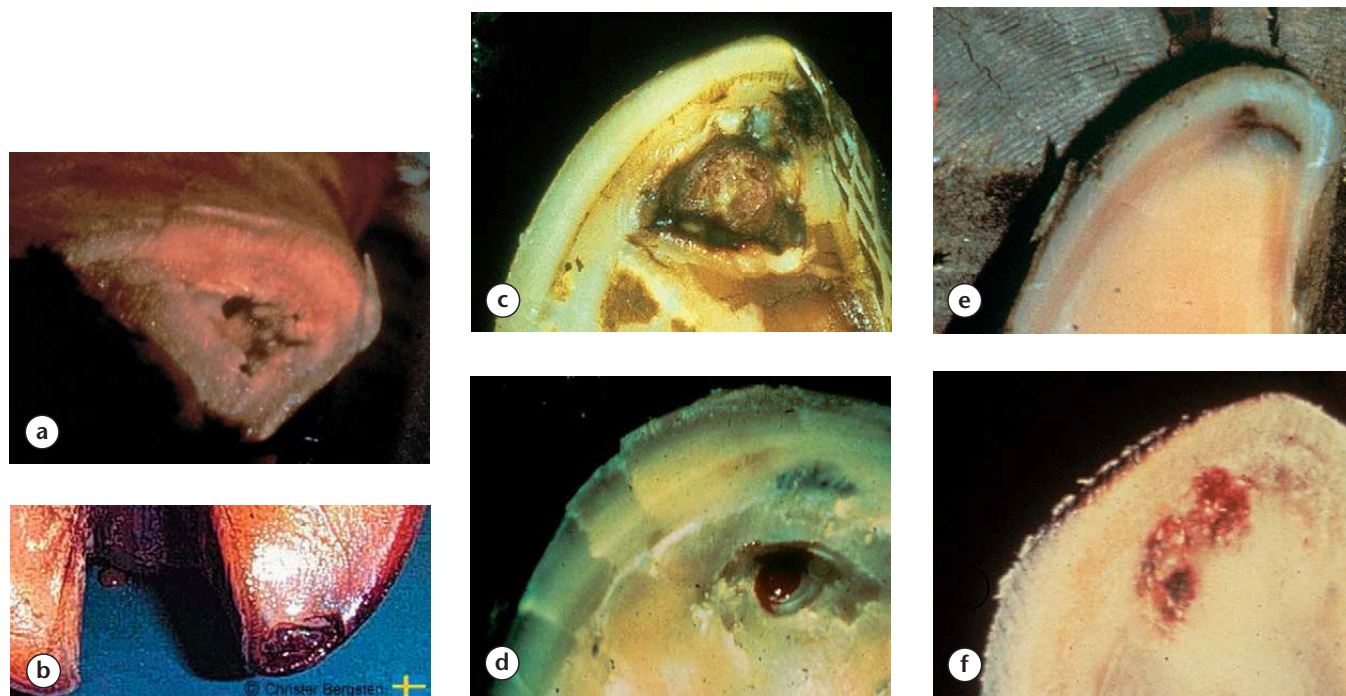


Figure 7-28 Toe abscess (a) & (b) and toe ulcer (c)–(f).





Figure 7-29 In the early stages of a developing toe ulcer, the white line in the apex of the sole (zone 1) will be stained with serum or blood. (Courtesy of J Naylor)



Figures 7-31 & 7-32 In more advanced cases, the corium appears to prolapse through the sole. The degree of lameness depends on the severity of the lesion. However, in most cases an affected claw will cause the limb to be camped forward. (Courtesy of K Mortensen)



Figure 7-30 In some cases serum will exude from the white line at the apex of the claw.



**Figure 7-33** The prolapsing phase is sometimes described as ‘sinking of the pedal bone’ which is comparable to rotation of the toe bone seen in horses. Sinking of the apex of the pedal bone is seen in intensively fed young cattle. (Courtesy of C Bergsten)

## Cause

Toe ulcers have been recognized only in relatively recent years. Their appearance has been concurrent to some extent with the increasing awareness of the prevalence of subclinical laminitis.

## TECHNICAL COMMENTS

One explanation of the cause of this disorder may be that the toe ulcer in mature cows is the result of rotation of the pedal bone inside the capsule. It has been suggested that the release of MMPs (p. 47) causes the breakdown of the suspensory apparatus of the digit (p. 26). The epidermo-dermal lamellae are particularly extensive under the dorsal wall of the claw capsule, therefore, failure of the suspensory apparatus in the region is likely to produce dramatic results. There is a progressive degradation of collagen fibrils by the activated form of MMPs weakening the suspension of the bone. As a result, the fibers between the lamellae and the bone either stretch or tear away from the inner surface of the wall. Depending on where the damage is most advanced, the displacement of the bone commences and exerts pressure onto the living tissues beneath. Excessively long periods standing (e.g., in a holding yard) probably accelerates this process.

Failure of the circulation in the apex of the claw can gradually cause rarification of the bone (osteolysis) which can be observed radiographically.

## Treatment

### KEY CONCEPT

- If the disorder has progressed to the point of prolapse, it may be irreversible.

Temporary protection for a toe ulcer can be given by applying a layer of methyl methacrylate (MM; see Chapter 17, pp. 268–271). The exposed dermis should appear healthy and a layer of granulation tissue should be present.

Most lesions will require a few days preparation before MM can be safely applied (see pp. 268–271). The first step, therefore, is to expose the area to an antibiotic. For this purpose, gauze impregnated with petroleum jelly and penicillin is very effective. The dressing should be bandaged in place with a waterproof cover for 48–72 hours. This procedure reduces the bacterial burden in the lesion. The horn around the affected area should be pared away and the surface lightly grooved to improve the adhesion of the acrylic. The exposed surface and prepared sole should be sterilized with alcohol and dried using a heat lamp or hair drier. Antibiotic powder should be applied to the tissue. The acrylic is then molded around the entire toe. Under normal temperature conditions, the curing of the methyl methacrylate must be slowed down considerably by running cold water over the acrylic. If this is not done, the heat generated will be extremely painful for the patient.

Some workers employ a plastic ‘slipper’ with a closed toe cup for this procedure. A useful tip is to make an insert cut from 5mm automobile inner tubing and place it inside on the sole of the shoe. This will provide better cushioning during weight-bearing. Adhesive is applied to the inside of the toe cap, but not to the sole. After the affected claw has been inserted into the shoe, adhesive should be applied to the sole wall and overlapped onto the toe cap.

If necrotic corium protrudes through the opening in the sole it is very likely that the apex of the pedal bone has suffered a physiological fracture. This type of fracture is caused by blockage, possibly pressure, cutting off the blood supply to the bone (Fig. 7-37). Radiographic examination is recommended, and if the diagnosis of fracture is confirmed, the necrotic apex of the bone should be removed. This is a relatively simple procedure which would be strongly indicated if the animal is particularly valuable (see pp. 266–268). An abscess in the white line at the apex of the sole can be caused by a foreign body (Figs 7-34–7-36).



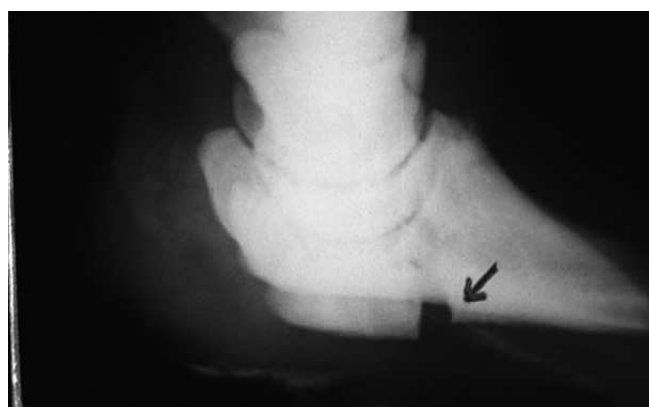
**Figure 7-34** The equine hoof testing caliper is an excellent instrument for detecting a painful lesion in the sole of the claw of a cow. (Courtesy of J Malmo)



**Figure 7-35** This foot appears to have very little wrong with it although the cow was acutely lame. Caliper pressure detected pain close to a defect in the white line. A thin layer of sole was shaved away and pus escaped from the defect. (Courtesy of J Malmo)



**Figure 7-36** Careful dissection of the sole revealed the extent of the abscess. Although the pedal bone is exposed the dermis will regenerate if the lesion is adequately protected from further damage and infection. (Courtesy of J Malmo)



**Figure 7-37** When the blood supply to the pedal bone is impaired due to inflammatory congestion or a thrombus fracture of the apex of the distal phalanx can occur. This type of fracture frequently involves the coffin joint and may be referred to as a 'physiological fracture.' (Courtesy of U Bargai)

## Control

Measures applied to control subclinical laminitis are likely to reduce the incidence of this condition. There is probably a traumatic component to the etiology of the disorder. Walking long distances, poor-quality concrete, and lack of good bedding could all increase the incidence of this phenomenon.

## TOE ABSCESS

### KEY CONCEPTS

- Toe abscesses affect beef cattle aged 10–12 months. The cause is uncertain.
- This disorder reportedly occurs about 10 days after prolonged periods of transportation. It has been described since the mid 1990s and only in North America.

## Description

Affected cattle develop severe lameness 3 days to 3 weeks after being processed (i.e., castrated, dehorned, and vaccinated) after weaning and transportation. Lameness and/or recumbency is noticed up to about 10 days after admission to the feedlot.

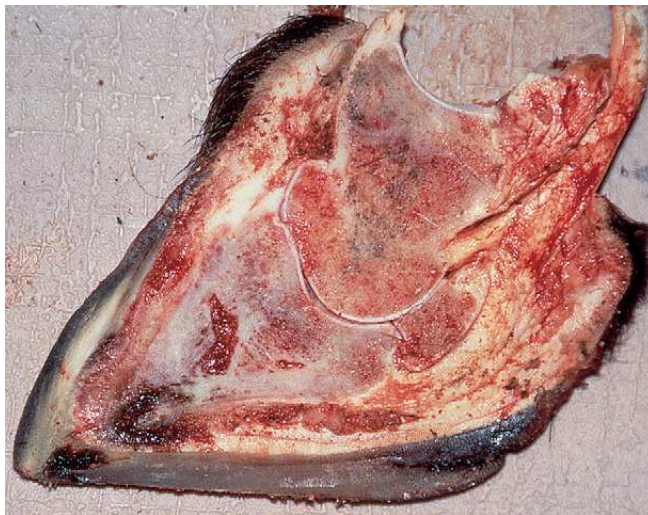
The lateral claws of the hind feet are most commonly involved. An affected calf rapidly loses condition. Those that remain recumbent often contract pneumonia. This accounts for the high mortality from this disorder.

Examination of the sole may reveal abnormal wear of the apex of the sole, swelling, and tenderness around the coronary band. The body temperature is usually elevated. An opening may be found at the apex of the sole with drainage of a foul-smelling liquid (Fig. 7-38). In some cases, infection may spread up the limbs causing cellulitis (a phlegmon). The morbidity rate can reach 50% of the animals in a lot. These are referred to as open toe abscesses.

Sometimes, this lesion may be present without there being a clinical sign other than lameness or recumbency (Fig. 7-39). In these cases, the apex of the claw should be pinched with hoof testers to ascertain the level of tenderness in the region (Fig. 7-34).



**Figure 7-38** In the apex of this claw there is an opening to the outside. The tip of the bone also appears to be diseased. (Courtesy of C Bergsten)



**Figure 7-39** The sole of this claw is thin under the apex, but there is no opening. The apex of the bone could be diseased and two double soles are present. (Courtesy of C Bergsten)

## Possible Causes

### GLOSSARY

**Hypostasis:** Settling of blood in a dependent part of the body.

**Phlegmon:** Suppurative inflammation of a part, especially the connective tissues. A term commonly used in continental Europe to describe foot rot.

**Necrosis:** The pathological death of a group of cells in contact with living cells.

**Ischemia:** Local diminution in the blood supply, due to obstruction of the inflow of arterial blood.

The cause of toe abscesses has never been proven satisfactorily. There are two main hypotheses:

(a) *Trauma.* There is a strongly held opinion among feedlot operators that the excessive wear associated with this disorder is caused by contact with rough abrasive concrete or rough frozen surfaces. Excitability of animals, particularly when being loaded up ramps with metallic 'grips,' has also been implicated. Very low ambient temperatures may contribute to the pathologic changes observed. It has also been noted that in rare cases damage to the coronary band can cause accelerated growth of the dorsal wall of the claw.

(b) *Physiological disturbance.* Necrosis of the apex of the pedal bone and an abscess connecting with the exterior is the typical finding. However, some cases have no opening to the exterior and this suggests the pathology starts internally. In the latter case extremely high pressure inside the claw caused by hypostasis causes ischemia and necrosis, followed by rupture of the white line at the apex.

Figures 7-38 to 7-40 are a series of photographs of beef yearlings affected with toe abscesses. Some of these claws showed no connection with the exterior, suggesting that they represented an early stage of the disorder. Some had significant evidence of a double sole. Furthermore, an alteration in the appearance of the horn pattern on the exterior surface of the claw presents historical evidence of an 'insult' having occurred some weeks prior to the animal's death (Fig. 7-40).

This evidence suggests that physical damage to the exterior of the claw cannot alone account for this disorder, although it could be a contributing factor. Other factors are likely to be implicated, such as hypostasis resulting from prolonged inactivity on the part of the animal.

There is necropsy evidence that the animal sustained an insult, probably nutritional, some time before death. Whether this can be classified as 'laminitis-like' is a matter of conjecture. Calves grazing aftermath pastures that have been irrigated have developed toe abscesses. This suggests that a boost in the quality of the diet just prior to the process of conditioning and shipment could precipitate the disorder.



**Figure 7-40** This is the same claw as in Figure 7-39. Notice the distinct ridge on the surface of the wall. This ridge, together with the double sole, is suggestive of laminitis-like episodes caused by stress and/or a nutritional disturbance. (Courtesy of C Bergsten)

### TECHNICAL COMMENTS

Can factors associated with transportation be a major contributing factor?

Canadian regulations for transporting cattle require them to be watered and fed for 5 hours prior to transportation. The regulations also state that animals must be watered and fed every 48 hours while being transported, unless they can reach their destination in 52 hours. Similar regulations exist in the United States, but there are so many exceptions that transportation of cattle is probably poorly controlled. Italian studies shown that a stop for 24 hours, after the first 19 hours of a journey can have a negative affect on the health of the feet.

In practice, the transportation scenario for many calves is extremely stressful. Calves have to be packed tightly into trucks in order to prevent them from lying down. The reason for this is that a lying animal would be trampled. Truck drivers are required by law to take a rest of several hours after having been on the road for up to 9 hours. While the drivers sleep, the calves are forced to remain standing as there is no legal requirement for them to be unloaded, watered, and fed for 48–52 hours.

There are two possible factors that could have a negative effect on the feet during transportation. Firstly, the blood will pool in the feet for lack of exercise. The pressure inside the claw capsule will increase; the tissues will be deprived of oxygen. This would account for bone necrosis. Secondly, cattle start the journey with a rumen full of feed and water. Standing for hours in overcrowded conditions the calves will be unlikely to ruminate. For lack of saliva, the rumen environment will become acidic. Gradual dehydration could also have a negative effect on the environment of the rumen.

The foregoing observations are pure supposition unsupported by controlled clinical trials. Nevertheless, the facts do suggest a rational explanation for the occurrence of this condition.

### Treatment

Various oral and injectable antibiotics have been tried with little success. Topical treatment consists of removing, under regional anesthesia, the apex of the claw with hoof cutters. Necrotic bone may be shed. Topical dressing

with antibiotic and protection of the wound with a waterproof bandage are appropriate. Whether such a procedure is cost effective is debatable.

### Control

In all probability, the toe abscesses seen in yearling beef cattle have more than one contributing cause. The condition is clearly associated with new arrivals in a feedlot. Quiet handling of the animals on arrival and avoidance of abrasive surfaces are recommended. If the calves have traveled some distance or a considerable time has elapsed since they were first loaded, care must be taken to ensure a gradual increase in feed. However, attempts to prevent the disorder from occurring by acclimatizing the calves to a change of ration over a 30-day period have failed.

## DOUBLE SOLE

### Description

A double sole is a condition in which the entire sole can be stripped away right to the apex of the claw, exposing a developing second sole beneath. There can be more than one sole if the cause has been repeated (Figs 7-41–7-43).

In the early stages, lameness is not recognized nor is a lesion obvious (Fig. 7-44). Double (false) sole can be an occasional finding during the routine trimming of an otherwise sound and not lame animal. The animal may walk in a peculiar manner as usually all of the claws will be affected at the same time.



**Figure 7-41** This is a cross-section of a claw with a double sole showing (a) new sole, (b) inter solear space, (c) old sole. The distortion of the wall horn at the toe suggests that a 'laminitis-like' episode was involved in the etiology. (Courtesy of P Ossent)

## Cause

It is proposed that a sudden, serious, probably short-term, disturbance in the microcirculation of the dermis of the sole results in an effusion of serum, separating the dermis from the epidermis. This disturbance in the circulation is caused by an 'event' after which the horn of the sole starts to be produced once more. Thus a new sole and an old sole are present at the same time.



Figure 7-42 In this case it appears that a penetrating foreign body may have been involved in causing a separation between corium and sole. (Courtesy of K Mortensen)



Figure 7-43 The appearance of the apex of the pedal bone suggests a necrotic process which may have a traumatic cause as the double sole is confined to the anterior region of the sole. (Courtesy of Anon)

Most workers consider that the most common 'event' associated with double sole is a 'laminitis-like' episode. The pathogenesis of double sole is unknown. It is proposed that introduction overnight to a moderate production ration from a dry cow ration can cause a double sole. It seems that the suddenness of the change is the important factor rather than the degree of change. The rumen microflora require time to adapt.

Certain toxicities, such as feeding mouldy hay, are known to cause double sole.

Bruising of the sole can be a contributing or precipitating factor. This has been seen to occur when cattle are required to walk on roadways soon after the claws have been trimmed.



Figure 7-44 As the superficial sole wears away new sole is exposed. This may be discovered in many cows during hoof trimming and suggests that a previously unsuspected insult occurred some months previously. This is also seen if a herd is forced to walk on hard surfaces immediately following trimming.

## Treatment

### KEY CONCEPTS

- NEVER remove all of the old sole at one time.
- NEVER permit cows that have just had an old sole removed to walk any distance on roadways.
- If one foot is affected, it is likely that other claws will have lesions.
- If one cow in a herd is found to have a double sole, it is possible that other cows in the same group may also be affected.
- If several cows in a herd have double soles, look for a common 'event' that took place 2–3 months previously.

The old sole protects the new sole. For at least 24 hours after the old sole is removed, the new sole is wet, soft, and very vulnerable to damage. Therefore, only a portion (no more than 30%) of the sole covering the bulb should be removed during the first treatment (Fig. 7-45). The abaxial wall at the junction of the wall with the heel must remain completely intact in order to lift the vulnerable new sole from contact with the ground. The animal should be confined to a well-strawed loose box for 24 hours or until the new horn has hardened.



**Figure 7-45** The superficial horn (old sole) is usually attached at the apex of the sole. The exposed sole is usually soft and vulnerable. It is important to leave the abaxial wall in place at the heel to prevent damage to the new sole.



## UNDER-RUN HEEL

### Description

The horn of the heel, being soft and flexible around the bulb, can be partially reflected in order to examine the space between corium and sole. Purulent material is invariably present. This condition is often confused with double sole. The distinction is that an under-run heel only involves the posterior 25% of the sole, while the double sole involves the entire sole.

See Figures 7-46 and 7-47.



**Figure 7-46** Detachment of the heel-horn from around the bulb is a typical clinical sign of under-run heel. In this case the condition is probably a sequel to a white line lesion. (Courtesy of J Malmo)



**Figure 7-47** This condition is frequently confused in appearance with a double sole. The horn covering the heel bulb separates from the corium at the white line. (Courtesy of C Bergsten)

### Cause

It is very likely that the under-run heel is most commonly associated with the white line disorder described on page 93 (see also Fig. 7-46). This is likely to be the case if no foreign object can be detected, but a small patch of necrotic tissue can be observed after removal of the loose horn. Pus formation causes detachment of the heel horn.

Some cases are caused by a foreign body penetrating the sole at or behind the junction of the sole and the heel of the claw.

### Treatment

The horn of the solear surface of the bulb should be cut away up to the location of the entry point of the foreign body. However, it is extremely important to leave the abaxial wall intact in order to remove weight-bearing from the now vulnerable surface of the heel. Ideally, the animal should be confined to a dry, soft surface until the newly exposed horn has dried and hardened. In many cases, it may be desirable to fit a 'lift' to the unaffected claw.

**BIBLIOGRAPHY**

- Acuña R, Scarsi R 2002 Toe ulcer: the most important disease in first-calving Holstein cows under grazing conditions. Proceedings of the XII International Symposium of Disorders of the Ruminant Digit, Orlando, p 276–279
- Amstel van S R, Shearer J K 2000 Toe abscesses: A serious cause of lameness in the U.S. Dairy Industry. Proceedings of the XI International Symposium on Disorders of the Ruminant Digit, Lucerne, p 212–214
- Apley M D 1998 Toe abscesses. *Veterinary Clinics of North America: Food Animal Practice* 14(2):300–301
- Bargai U 1997 An unusual outbreak of solar ulcers in an Israeli dairy herd. *Israel Journal of Veterinary Medicine* 52:91–92
- Chesterton R N, Pfeiffer D U, Morris R S et al 1989 Environmental and behavioural factors affecting the prevalence of foot lameness in New Zealand dairy herds. *New Zealand Veterinary Journal* 37:135–142
- Clackson D A, Ward W R 1991 Farm tracks, stockman's herding and lameness in dairy cattle. *Veterinary Record* 129:511–512
- Edwards A 1984 Preventing toe abscesses. *Feedlot Management* April p 39–42
- Fessl L 1968 Biometric studies on the ground surface of bovine claws and the distribution of weight on the extremities. *Zentralblatt für Veterinärmedizin* 15:844–860
- Greenough P R 1996 White line disease at the toe (Toe Ulcer). In: Greenough P R, Weaver A D (eds) *Lameness in cattle*. W B Saunders, Philadelphia, p 108
- Griffin D, Perino L, Hudson D 1993 University of Nebraska extension publication G93-1159-A
- Hahn M V, McDaniel B T, Wilk J C 1986 Rates of hoof growth and wear in Holstein cattle. *Journal of Dairy Science* 69:2148–2156
- Hassall S A, Ward W R, Murray R D 1993 Effect of lameness on behaviour of cows during summer. *Veterinary Record* 132:587–580
- Hoblet K, Weiss W, Anderson D 2002 Effect of oral biotin supplementation on hoof health in Holstein heifers during gestation and early lactation. Proceedings of XIIth International Symposium on Lameness in Ruminants, Orlando, p 253–256
- Kofler J 1999 Clinical study of toe ulcer and necrosis of the apex of the distal phalanx in 53 cattle. *Veterinary Journal* 157(2):139–147
- Miskimins D W 1994 Bovine toe abscesses. VIIIth International Symposium on Disorders of the Ruminant Digit, Banff, p 54–57
- Miskimins D W 2002 Update on toe abscesses in feedlot cattle. Proceedings of XIIth Symposium on Disorders of the Ruminant Digit, Orlando, p 448–449
- Ossent P, Lischer Ch J 1998 The significance of the suspensory mechanism of the third phalanx and its fat bodies in the pathogenesis of sole ulcers in cattle. Part II Microscopic findings. XIth International Conference on Bovine Lameness, Parma, p 226–229
- Prentice D E 1973 Growth and wear rates of hoof-horn in Ayrshire cattle. *Research in Veterinary Science* 14:285–287
- Rakes A H, Clark A K 1984 Feet and leg problems in dairy cattle as influenced by nutrition. Proceedings of the Florida Nutrition Conference, Clearwater, p 153–163
- Rusterholz A 1920 The specific traumatic sole ulcer of claws in cattle. *Schweiz Archiv Tierheilk* 62:421–466
- Smith D R, Broderson B W 1998 Lesions of the hoof wall, sole and skin associated with osteomyelitis of the distal third phalanx (toe abscess) and other secondary foot lesions in feedlot cattle. Conference for research workers in animal disease, abstract 45.
- Scott T D, Naylor J M, Greenough P R 1999 A simple formula for predicting claw volume of cattle. *Veterinary Journal* 158:190–195
- Schaik van P 1952 A gradually increasing defect in black and white cattle. *Tijdschrift Diergenesk* 70:908
- Schaik van P 1956 Defects of the hind hooves and hind limbs of Dutch Friesian cattle. *Tijdschrift Diergenesk* 81:624
- Stokka G L, Lechtenberg K, Edwards T et al 2001 Lameness in feedlot cattle. *Veterinary Clinics of North America* 17:189–207
- Vermunt J J, Greenough P R 1995 Structural characteristics of the bovine claw: horn growth and wear, horn hardness and claw conformation. *British Veterinary Journal* 151:157–180
- Wheeler J L, Bennet J W, Hutchinson J C D 1972 Effect of ambient temperature and day length on hoof growth in sheep. *Journal of Agricultural Science* 79: 91–97
- Westra R 1981 Hoof problems in cattle. Is there a relationship with trace mineral levels? Proceedings of the 2nd Western Nutrition Conference, Edmonton, p 115–132
- White E M, Glickman L T, Embree C et al 1981 A randomized trial for evaluation of bandaging sole abscesses in cattle. *Journal of the American Veterinary Medical Association* 178:178–377

# Pasture Managed Cattle

### GLOSSARY

**Trackway:** (Rare in Australasia). These are the lanes or roadways that the animals must traverse to and from pasture and the milking station.

**Slug Feeding:** This is the practice of feeding concentrates only once or twice daily.

**Bail:** (Australasia and UK). This is any form of milking station (permanent or mobile) that is located for the convenience of rounding-up cows at pasture.

**Feeding Pad:** The equivalent to bunk feeding in North America.

**Set stocked:** A term used in Australasia to indicate permanent pasture.

### INTRODUCTION

#### KEY CONCEPT

- The cause of bovine lameness under pasture management conditions is predominantly associated by trauma occurring on poorly maintained trackways when cattle are being herded by impatient personnel.

Pasture management is practiced mainly in temperate and tropical climates in areas where the cost of land makes the practice economically feasible. The incidence of lameness in herds managed at pasture has been reported to be 7.5% in Australia and 14% in New Zealand. Data on the incidence of lameness in South America is not reliable, but is generally considered to be higher than in Australasia.

Infectious diseases of the digital region probably accounts for up to 20% of the lesions causing lameness. A high percentage of the remaining lesions are traumatic in origin, being mainly related to trackways and poor environmental conditions. Lesions consistent with subclinical laminitis have been described for dairy cattle in Australasia and South America.

See Figures 8-1 and 8-2.



Figure 8-1 Dry winter pastures in Uruguay require supplementary forage feeding. (Courtesy of R Acuña)



Figure 8-2 Spring pasture with cows in the background passing along a trackway. (Courtesy of J Malmo)

## TRACKWAYS

### KEY CONCEPTS

- Over 40% of lameness is associated with moving cattle over tracks.
- Another 24% of lameness is associated with milking management.

### Management of Trackways

According to the Sociedad de Creadores Holando Argentino, dairy cows in Argentina walk, on average, along trackways four times each day, covering about 5km in total. In New Zealand, dairy cows also walk trackways to pasture, and there is a strong association with the incidence of lameness. In New Zealand, the problem is thought to be made much worse by the impatience of the producer to hurry the animals along a track. Dogs and motorbikes are used to drive the animals. In contrast, cows in Argentina may have the incentive of feed to attract them to the milking parlor.

It is important that a cow should be allowed to 'drift' along at her own speed. A cow that is 'drifting' will have her head down in order to visually select where she is placing her feet. As she walks on, her back feet automatically land on the spot the front foot has just vacated. Cows that are being driven have their heads above the rump of the cow in front, and those at the rear of the column wander from side to side along the track. This behavior becomes more intensive when the herd reaches a point within 300 meters of the milking facility (Table 8-1). The incidence of lameness is higher in the last 25% of the cows being driven and is more prevalent in the cows that are in milk. Allowing cows to move along the track at their own pace can at least partly overcome the effects of inadequate track maintenance. Clinically lame cows tend to congregate at the back of the herd, and so they are more prone to be affected by an impatient stockman.

Patient and gentle handling is also important in the cow yards. Forcing cows to twist and turn on concrete increases hoof wear and the risk of hoof injury.

Many roadways are too narrow to accommodate large herds. The condition of some roadways is extremely poor, the surfaces being uneven and having deep pot holes which traumatize the skin of the foot. In rainy weather, lack of proper drainage leads to excessively muddy conditions which contribute to the disintegration of the skin

Table 8-1

CHARACTERISTICS OF POOR AND GOOD TRACKWAYS*		
	Highest Prevalence	Lowest Prevalence
Average Width of Track	4.02m	4.76m
State of Maintenance	3.56	2.68
Points Congestion	6.13	2.68
Patience of Farmer	3.13	2.00
Space in Yard per Cow	1.27m <sup>2</sup>	1.08m <sup>2</sup>

\*After Bridges (1985)

of the foot. It has been found that it is common for conditions to be wet during the week prior to lameness.

Tracks should not be used for holding stock in wet weather or holding stock before milking. Farm tracks should not be used as temporary feeding pads. All of these practices will lead to rapid deterioration of the track.

## Design and Construction of Trackways

### KEY CONCEPT

- Surfaces used by farm vehicles are generally incompatible with those for cows and ideally the two should be kept separate.

It has been said that the three most important points with respect to farm track construction are drainage, drainage, and drainage. If the farm track is not well crowned and well drained, it will be very difficult to maintain. To minimize lameness, both well-maintained and well-constructed farm tracks are needed, as well as patient and gentle people handling the cows.

*Guidelines for track width as a function of herd size:*

< 120 cows	5.0m
120–250cows	5.5m
250–350cows	6.0m
350–450cows	6.5m.

Tracks should be as straight as possible. Right-angle bends should be avoided at all costs. Narrow parts of the track, as well as bends, tend to slow down the flow of cattle. If possible, the track should not pass by trees that would shade the surface and delay drying out. consideration should be given to the placement of culverts and drains to avoid the flow of water onto the track.

Grass and topsoil must be removed when a new track is being built. A sound base must be constructed, the surface of which should be above the level of the surrounding land. Gravel is the best material to use for the base, but it must be properly compacted. The greater the compaction, the less absorption of moisture. The surface should be crowned with a cross fall between 3% and 6%. Provision for run-off should be provided on either side of the track. The ideal mixture to top the surface of the track is gravel, sand, and clay.

## Maintenance of Trackways

It is important to maintain the quality of trackways, but many producers in Argentina, for example, attach little importance to this matter. Manure from the track surface eventually may find its way to the run-off channels located on either side of the track. After time, these may block and cause flooding, which will accelerate deterioration of the surface. The problem can be corrected by running a blade down the gutter and turning the debris out beneath the fence line.

See Figures 8-3–8-8.



Figure 8-3 A narrow track deep in mud causes considerable traumatic damage to the feet. (Courtesy of R Acuña)



Figure 8-4 Tracks should be wide enough to avoid overcrowding and sufficiently smooth to allow comfortable walking. (Courtesy of J Malmo)



Figure 8-5 Trackways that are lower than the surrounding land become exceptionally muddy. (Courtesy of J Malmo)



Figure 8-6 Tracks should be properly constructed. The first step is to create a base of well-compacted, crushed rock fill. The finished track surface should be above that of the surrounding ground. (Courtesy of J Malmo)



Figure 8-7 The elevated track should have drainage ditches on either side. (Courtesy of J Malmo)



Figure 8-8 Even on good roads, cows will select the area most comfortable on which to walk. Walking single file may indicate avoidance of small stones. (Courtesy of J Malmo)

## THE MILKING YARD

### KEY CONCEPTS

- The lower the density of cows in the yard the higher will be the risk of lameness.
- Cows waiting to be milked should not be allowed to wait on concrete for more than 2–3 hours per day.

In Australia, milking time is commonly up to 2 hours per milking. In some large herds with inadequate facilities, this may build up to 3–4 hours per milking.

The area of transition between the farm track and the milking yard needs special attention. The problem is that material, particularly sand, can be carried on cows' feet from the track to the milking yard. There should be a distinct junction between track and yard from which a concrete apron slopes down to the track on one side and down to the yard on the other.

Cows need at least 1.3–1.5m<sup>2</sup> per cow to comfortably congregate in a yard. Extreme care should be used when employing cramping devices (electric or metal gates) to increase the density of cows in the holding yards. Lifting their heads and moving from side to side is



**Figure 8-9** Although the floors of milking bails may be in good condition, the feet are subjected to trauma when they enter the trackways upon returning to the fields. (Courtesy of J Malmo)

an indication that the cows are being excessively cramped.

When the cows emerge from the milking station, they should be encouraged to move back along the trackway to the pasture. Holding cows in a trackway so they can be allowed back to a fresh paddock all at the same time is not wise. The accumulation of manure can obstruct drainage and accelerate the deterioration of tracks.

See Figure 8-9.

## PASTURE, NUTRITION, AND LAMENESS

### GLOSSARY

**NDF = Neutral-Detergent Fiber:** Measures most of the structural components in plant cells that are slowly degraded in the rumen to yield volatile fatty acids. Minimum concentrations of NDF required for optimal rumen function range from 25% to 33% of dry matter, depending on total dietary levels of forage NDF. Current recommendations are that 19% of the dietary dry matter must be NDF from forage; however the NDF concentration must be higher if the forage is finely chopped.

**eNDF = Effective NDF:** This is the effectiveness of dietary fiber to maintain milk fat percentage.

**peNDF = Physical NDF:** This is the physical characteristics of fiber and the ability of the diet to stimulate chewing.

**PEF = Physical Effective Factor:** This is the ability to stimulate chewing, with long-grass hay setting the theoretical standard of PEF of 1.

**ADF = Acid Detergent Fiber:** The relatively indigestible components of forage. Diets should contain not less than 19–21% ADF on a dry matter basis.

### KEY CONCEPT

- The quality of fiber must be considered as the governing factor in controlling the pH of the rumen, whether the cows are grazing fresh pasture or consuming winter forage.

## Some Characteristics of Pastures

Lesions normally associated with subclinical laminitis have been reported to be increasing in cattle managed on pasture. Rumen acidosis has been implicated in this disorder in high-production, intensively managed cattle, but it is difficult to understand how this can occur with cows on a grass diet. Many hypotheses and assumptions have been applied to this problem, but no believable rationale has yet emerged.

Whether cows are managed intensively or not, feedstuffs digested in the rumen produce volatile fatty acids (VFA). These are absorbed by the rumen papillae and are a factor in reducing rumen pH. Feeding low-quality forage for a prolonged period reduces the surface area of the papillae. In the spring, there is a transition period during which the rumen adapts to a high-quality diet. During this period, the rumen may be unable to absorb all of the VFA until the papillary surface has regenerated. A drop in rumen pH is to be expected. Consequently, there will be a greater risk of ruminal acidosis when high-production cows are exposed to lush vegetative pastures. The same can be said of recently calved dairy cows that have been maintained on poorer pastures during the dry period. This may be particularly expected in Australasia where highly digestible ryegrass and white-clover pastures are common.

Another factor common to both intensive and pasture management systems is the mechanism stimulating the production of buffer-rich saliva. It has been estimated that a lactating dairy cow produces 108–308L/day of saliva which is equivalent to the addition of 108–1,115g/day of disodium phosphate and 1,134–3,234g sodium bicarbonate respectively. Salivation is dependent on rumination, and rumination is dependent on the fiber content of the diet.

Temperate grasses are frequently characterized by high moisture content. Cows consuming such pastures produce less saliva than the same forage would if fed as hay or high dry-matter silage. Less saliva means a reduction of buffers flowing into the rumen and potentially a lower rumen pH.

Low levels of neutral detergent fiber (NDF) or effective neutral detergent fiber (eNDF) are also associated with reduced saliva flow. More than 14% of high quality pasture NDF is degraded per hour compared with 5% for mature grasses. The higher the rate of degradation, the higher will be the yields of VFA, which will lower rumen pH. The physical characteristics of NDF from long forage have important effects, including maintenance of normal ruminal pH, stimulation of chewing and rumination activity, forming the floating ruminal mat of large particles above the liquid pool of ruminal contents, and stimulation of ruminal motility.

## Changes in Pasture Quality

Nitrogen-boosted, lush, high-quality pasture grass is rapidly rumen degradable, producing high concentrations of rumen volatile fatty acids. This may place cows at greater risk of low rumen pH.

Nitrogen-boosted pastures can contain less dry matter and more water, lower fiber and more nitrogen and non-protein nitrogen (NPN) than non-fertilized pastures, especially during the first 4–6 weeks after application. The quality of feed will improve whenever cows are turned out onto pastures that have been fertilized or irrigated.

Cows grazing a predominantly grass diet experience a drop in the body-condition score after peak production. It has been reported that in New Zealand dairy cows often calve in poor body condition, and may actually gain condition after calving. True, spring-calvers will sometimes mobilize body condition after peak lactation, as this coincides with the rapid decline in pasture quality and quantity as the warmer weather of summer sets in.

When the ryegrass plant undergoes reproductive development in late spring/early summer, levels of fiber increase markedly. Ruminal pH is lower for cows grazing early-season grass than for cows grazing late-season grass, when the grass has 'hardened off.'

Some species of grass, including ryegrass, have a significantly lower fiber content when they are 7–15cm high than when they are more mature. Therefore, cattle grazing ryegrass at a short, lush, leafy stage are at greater risk of a suboptimal ruminal pH (< 5.8) than when cattle graze mature ryegrass containing proportionately more stem and seed-head and, therefore, fiber. Re-growth of ryegrass following silage harvest can be particularly lush and low in fiber.

Warm rainy weather can enhance the quality of grass in as little as 7–10 days. The provision of moisture by irrigation can have a similar result.

## Rotational Grazing

### KEY CONCEPT

- Do not overstock paddocks used for rotational grazing.

In Australia, it is said that the key to grassland management is not to allow cattle to overgraze pasture. Ideally, cattle are placed onto the pasture where it has built up to around 2,200kg dry matter per hectare (this is around



10–15cm high pasture). The cows should be allowed to graze the pasture down to around 1,300kg pasture dry matter per hectare (this is around 3–4cm high residual pasture after grazing). If the pasture is grazed shorter than this, plant reserves are severely depleted and it takes longer for the pasture to grow back to the required level.

Rotational grazing allows better control of pre- and post-grazing heights of the pasture. On average, rotationally grazed pastures are of higher quality (lower fiber and more rapidly digested) than permanent pastures (set stocked). Well-managed, rotationally grazed pastures will usually be leafier and lusher and not have the same build-up of stalky grass and dead material at the base of the sward, as can be experienced for set-stocked pastures. Re-growth on rotationally grazed paddocks is usually more even and leafy and of higher quality.

However, rotational grazing is not necessarily of higher quality than continuous stocking grazing. Depending on management the reverse can be true. Cows that are rotationally grazed do not have the same ability to selectively graze as when exposed to a set-stocked pasture. Cows on permanent pasture can choose to eat some poorer quality pasture while also selecting higher quality leaf to better balance their diet and maintain rumen pH.

With a well-managed rotational grazing system there should not be major changes in pasture quality from day to day, but unless care is taken rotational grazing can also mean cows could be subjected to more sudden changes in diet as they move from paddock to paddock. This is particularly true for spring-calved cows when they finish the first grazing rotation of 'winter saved,' relatively mature pastures and move onto the first re-growth paddocks in early spring.

Strip grazing (Fig. 8-10) is more labor intensive than rotational grazing, but it provides better control and monitoring of the feed intake of the herd. In Australia and New Zealand, the electric fence is used as part of the rotational grazing system. Depending on the rate of pasture growth, the area needed to give the cow adequate feed will vary, as will the rotation length (the interval from the time when the cows graze a paddock to when they will graze it again). For example, in the spring the pasture may be growing rapidly enough so that a 5-ha paddock might provide two feeds (the paddock will be divided in half using an electric fence, as part of the rotation system). In the winter, it might be necessary to give the herd the entire paddock to provide its requirements for the day.

Cattle have a distinct grazing pattern, which includes a major meal near sunrise. For this reason, management should be adjusted to avoid 'slug' feeding pasture at dawn. It must be emphasized that buffering capacity changes during the day.



Figure 8-10 Strip grazing allows a graduated access to fresh grass. (Courtesy of J Malmo)

### Oligofructoses in Pasture Grass

The role of non-structural polysaccharides found in pasture and the incidence of laminitis in pasture-fed cattle remains unclear. Lush, good-quality pasture contains relatively high concentrations of a non-structural polysaccharide, fructosan (typically present at 3–10% of dry matter). Recent research demonstrated a relationship between the ingestion of very high levels of oligofructoses and laminitis in cattle, indicating a potential role for oligofructoses in the aetiology of lameness for pasture-fed cattle. However, this research has not been able to demonstrate any improvement in milk production – although there were changes in patterns of fermentation rumen environment (pH)

### Crude Protein in Pasture Grass

In some countries, pastures mostly consist of a mixture of legumes (alfalfa and clover) with non-leguminous plants (50:50 mixture). High-quality pasture can contain over 30% of its dry matter in the form of protein. This is particularly the case in the spring, following warm wet spells and during aftermath growth in the fall. High-protein diets can depress the motility of the rumen and reduce the conception rate of cows.

The degradation of protein leads to a substantial loss of nitrogen in the form of ammonia and urea. This trend may neutralize up to 10–15% of volatile fatty acids produced. On the other hand, it has been suggested that high levels of ammonia and urea in the blood may have a negative effect on the germinal cells of the dermis of the claw. It has also been proposed that rumen ammonia

may accelerate the conversion of histadine to histamine. Histamine is known to play a role in acute laminitis.

New Zealand dairy cows regularly consume high levels of dietary crude protein from pasture. The ability of the rumen and/or liver to adapt to high concentrations of nitrogen suggests a potential link between rapidly degradable protein and lameness. This hypothesis may be less relevant for New Zealand cows than for cows in other parts of the world.

### Supplementary Forage

During winter, care must be taken to monitor the quality of supplementary forage. Maize silage, for example, can be low in effective fiber, particularly if the particles are chopped small.

Low silage pH (< 4.0), particularly corn (maize) when fed with lush high-quality pastures, can contribute to low rumen pH. Small particle length of corn silage is a common contributory factor to rumen acidosis in both pasture managed and intensive management systems.

Offering cows supplemental fiber may be warranted, especially when they are grazing newly-sown pastures. Mature alfalfa (Lucerne) and straw from cereal grains are an excellent source of effective fiber. Fiber content of pasture will be significantly higher during the winter non-growing season.

### Supplementation with Carbohydrates

In Australia, the amount of grain fed may vary from 1kg to 7kg of grain per cow (broken down into two feeds [slugs] given at the time of each milking). In years when the price of grain is low relative to the price of milk, higher amounts of concentrate are fed. When this happens, the incidence of sole hemorrhages and other changes consistent with subclinical laminitis can reach 60%. Slug feeding (all the concentrate fed during milking) is common as few farms have feeding pads or mixer wagons available.

In New Zealand, cows are fed a predominantly pasture-based diet; however, there is an increasing trend to feeding more concentrates and maize (corn) silage. There is a risk at some stages of the year of inducing a rumen lactic acidosis if supplementary energy is provided in combination with lush high-quality grass.

In South America, the amount of grain (corn, sorghum, cotton seed, malt, and sunflower) fed to grazing dairy cows is relatively high. In some cases, 200–250g of grain is fed for each liter of milk produced. These amounts are not likely to cause a problem unless the daily allotment is offered at one meal.

Increasing the grain ration by 0.25kg for multiparous cows and 0.20kg for primiparous cows each day after calving is a safe practice. However, it is wise to check that all of the concentrate is not given in only one daily meal and that the farmer is increasing the energy slowly after calving.

Another problem in South America is that producers are reluctant or unable to acclimatize cows to a high-production diet in the period leading up to calving. This is particularly injurious to heifers, which may have not been acclimated to concentrate. The importance of adequate transition feed management is being increasingly recognized in Australia.

A common practice in South America is to turn cattle into a corral to feed after milking. Several errors can occur – concerns with this practice include:

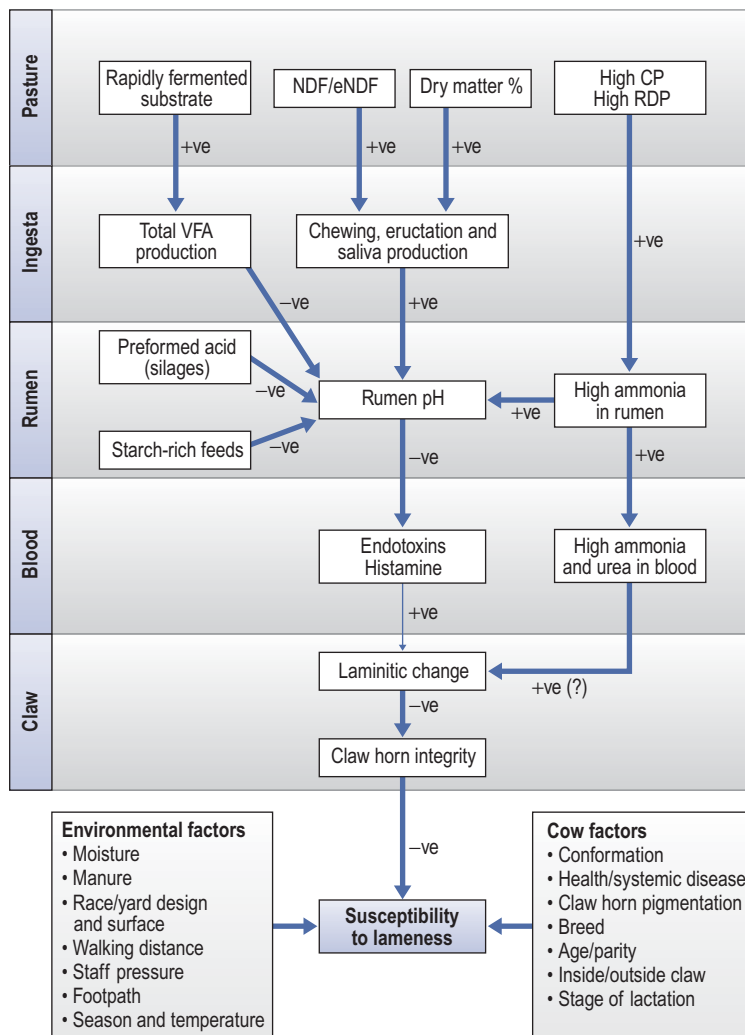
- The concentrate may not be mixed with the forage, resulting in some cows, usually dominant animals, obtaining more concentrate than they need for their level of production.
- Over-mixing feed will reduce the particle size of the forage and this will compromise the effectiveness of the fiber (see p. 65).
- There may be insufficient bunk space for the number of cows (see p. 78)
- All the concentrate may be fed in one meal – a risky practice even if the quantity is small.

### Indicators of Rumen Acidosis (see p. 58)

Testing the pH of samples of rumen fluid (see rumenocentesis, p. 57) is the only reliable method of assessing whether subacute ruminal acidosis exists in a herd. A pH of 6.4–6.8 is optimal for cow health and performance. Levels of 5.8 and lower are indicative of ruminal acidosis and suggest that a risk of subclinical acidosis exists. Recently workers in France have offered a word of caution and point out that low pH in rumen may result from different metabolic pathways, and only on those that end up in lactic acid accumulation can be linked to rumen pH and acidosis.

Reduction in milk-fat levels should be considered a possible sign of rumen acidosis. Reduced rumination or chewing, unaccountable loss of body weight, light-colored faeces with bubbles and/or mucoid casts all should be considered suspicious.

Cows that are lying down after feeding and spending less than 50% of the time ruminating should be a cause for concern. Westwood et al (2003) summarize the hypothetical aetiology of lameness in pasture-fed cattle in an excellent flow chart (Fig. 8-11).



**Figure 8-11 A proposed hypothesis identifying the proposed etiology of laminitis and lameness in cows fed primarily on pasture.** Key: CP = Crude protein; eNDF = effective neutral detergent fiber; NDF = neutral detergent fiber; RDP = rumen degradable protein; VFA = volatile fatty acids; +ve = positive association; -ve = negative association; +ve (?) = potential positive association. (Courtesy of C T Westwood et al 2003)

### Semi-pastoral Management Systems

When cows are turned out to grass only during the summer, care must be taken in disposing of barn manure on pastures in the spring. If organic fertilization is too heavy, mild nitrite/nitrate toxicity can result. This toxicity may exacerbate signs of subclinical laminitis.

It is very important to carefully monitor the transition periods during which the cows change from intensive winter feed to pastoral management. In the spring, there is always a risk that there will be a sudden drop in the fiber content of the diet and a sudden increase in crude protein. Similarly, at the end of the summer, the quality of the pasture can deteriorate more rapidly than anticipated, and a sudden introduction to

a high-production intensive ration can have serious results.

Whether there is seasonal change from pasture to housing and vice-versa or a seasonal change in the quality of pasture, there are unavoidable changes in the diet. Any circumstance that causes a *sudden change* in the quality of feed intake can cause problems.

### Rumen Modifiers

Rumen modifiers are claimed to be highly effective in controlling the growth of *Streptococcus bovis*, reducing the risk of acidosis, and decreasing the incidence of lameness (Table 8-2). Some of the commonly used products

**Table 8-2****META-ANALYSIS OF THE EFFECTS OF MONENSIN ON LAMENESS IN DAIRY COWS\***

Rights were not granted to include this table in electronic media.  
Please refer to the printed publication.

\*From Westwood et al (2003); Mantel-Haenzel fixed summary effects are reported and the studies are homogenous ( $p = 0.58$ )

are monensin (Rumensin; Elanco), lasalocid (Bovatec; Alpharma); tylosin (Tylan; Elanco); and virginiamycin (Eskalin; Philbro). These products are not cleared for use in milking cows in all countries, but their use in heifers may be of value. The role for rumen modifiers in moderating the risk of rumen acidosis in cows grazing only high-quality pasture remains unclear.

### Rumen Buffers

It is common practice in intensively managed systems to include chemical buffers and alkalizing agents in the diet, such as sodium bicarbonate, magnesium oxide, and sodium sesquicarbonate. These chemicals are unpalatable when fed in quantities in excess of 1.5% of the dry matter. For this reason, it may be difficult to supply enough chemical buffers and alkalizing agents in the concentrate portion of the ration. However, cows on pasture invariably crave salt, to which buffer and trace elements can be added. If free-choice supplements are offered at pasture, they must be placed in containers protected from rain and wind. The efficacy of sodium bicarbonate as a control measure for pasture-fed cows with acidosis remains questionable.

In Australia, many farmers feeding more than 3–4kg of concentrate per day will add buffers to feed (commonly sodium bicarbonate or magnesium oxide) as well as rumen modifiers (commonly monensin and sometimes virginiamycin). It is important to note that lime flour is not a rumen buffer and will not control rumen acidosis within the typical range of rumen pH, but may have beneficial effects in the hind gut.

### Monitoring the Mineral Status of Pastures and Supplementation (see p. 126)

#### KEY CONCEPT

- Marginal levels of trace elements alone are not known to cause foot disorders. However, they are believed to reinforce the effect of other risk factors.

Historical information regarding the micromineral availability in a region is usually known to the suppliers of supplements. This type of information is well publicized if there are special deficiencies such as those of copper and zinc or toxicities such as high levels of molybdenum or selenium.

Adequate copper and zinc are essential for the production of healthy claw horn. The role of these and other micro- and macrominerals is discussed in greater detail in Chapter 10. In some pastures, one or both of these minerals may only be available to the cow at marginal levels. However, the levels fluctuate between the plants in different pastures and at different times during the same season and from one year to another. There are usually no obvious signs that marginal levels of minerals are affecting the cattle; the evidence is purely circumstantial. Perhaps the quality of the claw horn may appear poor or the incidence of lameness has no simple explanation. Testing

pastures for trace elements provides useful background information. However, samples of pasture grass should be gathered by an expert in the field, otherwise results may be misleading. Blood samples taken from a cow may provide misleading information about the mineral status of the animal. For some trace minerals, liver biopsy samples provide reliable information but should be interpreted with caution.

Many pasture grasses are deficient in sodium and, therefore, common salt (sodium chloride) must be made available to cattle. This can be provided as rock salt or as part of a mineral supplement. Cows that are not fed grain will take a supplement offered to them in a trough which should be protected from the rain. Sprinkling salt-laced supplement on forage will often induce cows to accept high fiber even when they are grazing lush grass.

It should be noted that due to the coastal location of a high proportion of New Zealand grazing land, pasture grasses are rarely deficient in sodium. Sometimes levels over 0.5% of dry matter (DM) can be found. Some inland areas, typically more than 40km inland, can be low in sodium.

## BIBLIOGRAPHY

- Allen M S 1997 Relationship between fermentation acid production in the rumen and the requirement for physically effective fiber. *Journal of Dairy Science* 80:1447–1462
- Armentano L, Pereira M 1997 Measuring the effectiveness of fiber by animal response trials. *Journal of Dairy Science* 80:1416–1425
- Balch C C 1971 Proposal to use time spent chewing as an index of the extent to which diets for ruminants possess the physical property of fibrousness characteristic of roughages. *British Journal of Nutrition* 26:383–392
- Bargai U, Shamir I, Lublin A 1992 Winter outbreaks of laminitis in dairy calves: aetiology and laboratory, radiological and pathological findings. *Veterinary Record* 131:411–414
- Bargo F, Muller L D 2005 Grazing behaviour affects daily ruminal pH and 12 NH<sub>3</sub> oscillations of dairy cows on pasture. *Journal of Dairy Science* 88:303–309
- Beckett S D, Lean I J, Dyson R 1998 Effects of monensin on the reproduction, health and milk production of dairy cows. *Journal of Dairy Science* 81:1563–1571
- Beever D E, Dhnoa M S, Losada H R et al 1986 The effect of forage species and stage of harvest on the process of digestion occurring in the rumen of cattle. *British Journal of Nutrition* 56:439–454
- Boettcher P J, Dekkers J C M, Warnick L D 1998 Genetic analysis of clinical lameness in dairy cattle. *Journal of Dairy Science* 81:1148–1156
- Bridges D J 1985 Farm dairy race construction. *Proceedings of the Society of Dairy Cattle Veterinarians of the New Zealand Veterinary Association* 2:64–70
- Carruthers V R, Neil P G, Dalley D E 1997 Effect of altering the non-structural carbohydrate ratio in a pasture diet on milk production and rumen metabolites in cows in early and late lactation. *Animal Science* 64:393–402
- Chesterton R N 1989 Examination and control of lameness in dairy herds. *New Zealand Veterinary Journal* 37:133–134
- Chesterton R N, Pfeiffer D U, Morris R S et al 1989 Environmental and behavioural factors affecting the prevalence of foot lameness in New Zealand dairy herds. *New Zealand Veterinary Journal* 37:135–142
- Clackson D A, Ward W R 1991 Farm tracks, stockman's herding and lameness in dairy cattle. *Veterinary Record* 129:511–512
- Clark A K, Rakes A H 1982 Effect of methionine hydroxy analogue supplementation on dairy cattle hoof growth and composition. *Journal of Dairy Science* 65:1493–1502
- Clayton E H, Lean I J, Rowe J B et al 1999 Effects of feeding virginiamycin and sodium bicarbonate to grazing lactating dairy cows. *Journal of Dairy Science* 82:1545–1554
- Crichlow E C, Chaplin R K 1985 Rumen lactic acidosis: relationship of forestomach motility to non-dissociated volatile fatty acids levels. *American Journal of Veterinary Research* 46:1908–1911
- Dado R, Allen M S 1994 Variation in and relationships among feeding, chewing and drinking variables for lactating dairy cows. *Journal of Dairy Science* 77:32
- Dalley D E, Roche J R, Grainger C 2001 Effect of grain or buffer supplementation on milk solids yield and rumen fermentation patterns of cows grazing highly digestible herbage in spring. *Proceedings of the New Zealand Society of Animal Production* 61:224–228
- Donovan G A, Risco C A, DeChamp Temple G M et al 2004 Influence of transition diets on occurrence of subclinical laminitis in Holstein dairy cows. *Journal of Dairy Science* 87:73–84
- Duffield T, Bagg R, DesCoteaux L et al 2002 Parturition monensin for the reduction of energy associated disease in postpartum dairy cows. *Journal of Dairy Science* 85:397–405
- Duffield T F, Leslie K E, Sandals D et al 1999 Effect of a monensin-controlled release capsule on cow health and reproductive performance. *Journal of Dairy Science* 82:2377–2384
- Edwards N J, Parker W J 1994 Increasing per cow milk solids in a pasture-based dairy system by manipulating the diet: a review. *Proceedings of the New Zealand Society of Animal Production* 54:267–273
- Erdman R A, Moreland T W, Stricklin W R 1989 Effect of time of feed access on intake and production in lactating cows. *Journal of Dairy Science* 72:1210
- Fitzgerald T, Norton B W, Elliot R et al 2000 The influence of long-term supplementation with biotin on the prevention of lameness in pasture-fed dairy cows. *Journal of Dairy Science* 83:338–344
- Garrett E F, Pereira M N, Armentano L E et al 1999 Comparison of pH and VFA concentration of rumen fluid from dairy cows collected through a rumen cannula vs. ruminocentesis. *Journal of Dairy Science* 78(Suppl 1):299

- Harrison J H, Riley R E, Loney K A 1989 Effect of type and amount of buffer addition to grass silage-based total mixed rations on milk production and composition. *Journal of Dairy Science* 72:824–830
- Holmes C W, Brookes I M, Garrick D J et al 2002 Milk production from pasture: principles and practices. Massey University, Palmerston North
- Jubb T F, Malmo J 1991 Lesions causing lameness requiring veterinary treatment in pasture-fed cows in East Gippsland. *Australian Veterinary Journal* 68:21–24
- Jung H G, Allen M S 1995 Characteristics of plant cell walls affecting intake and digestibility of forages by ruminants. *Journal of Animal Science* 73:2774–2790
- Kalscheur K F, Teter B B, Piperova L S et al 1997 Effect of dietary forage concentration and buffer addition on duodenal flow of trans-C18:1 fatty acids and milkfat production in dairy cows. *Journal of Dairy Science* 80:2104–2114
- Kellaway R C, Porta S 1993 Feeding concentrates: supplements for dairy cows. Dairy Research and Development Corporation Publication, Melbourne
- Kennelly J J, Robinson B, Khorasani G R 1999 Influence of carbohydrate source and buffer on rumen fermentation characteristics, milk yield, and milk composition in early-lactation Holstein cows. *Journal of Dairy Science* 82:2486–2496
- Knott L, Webster A J, Tarlton J F 2004 Biochemical and biophysical changes to the connective tissue of the bovine hoof around parturition. *Proceedings of the XIIIth International Symposium on Lameness in Ruminants, Maribor*, p 88–90
- Kolver E S 1998 Digestion of pasture by dairy cows. *Proceedings of the 15th Annual Seminar of the Society of Dairy Cattle Veterinarians of the New Zealand Veterinary Association*, p 175–188
- Kolver E S 2000 Nutritional guidelines for high producing dairy cows. *Proceedings of the Ruakura Dairy Farmers Conference, Hamilton*, p 17–28
- Krohn C C, Munksgaard L, Jonasen B 1992 Behaviour of dairy cows kept in extensive (loose housing/pasture) or intensive (tie stall) environments. *Applied Animal Behavioural Science* 34: 37–47
- Krohn C C, Munksgaard L 1993 Behaviour of dairy cows kept in extensive (loose housing/pasture) or intensive (tie stall) environments. *Applied Animal and Behavioural Science* 37:1–16
- Lean I J, Clayton E H, Rowe J B et al 1998 Virginiamycin use in lactating dairy cows. *XX World Buiatrics Congress, Sydney*, p 203–206.
- Lean I J, Wade L K, Curtis A et al 2000 New approaches to control of rumen acidosis in dairy cattle. *Asian-Australasian Journal of Animal Sciences* 13(Suppl):266–271
- Mackie T R, Parr C R, Bryant A M 1996 Nitrogen fertiliser effects on milk yield and composition, pasture intake, nitrogen and energy partitioning, and rumen fermentation parameters of dairy cows in early lactation. *New Zealand Journal of Agricultural Research* 39:341–356
- Macky S 1994 Metabolic problems in high producing cows on a predominantly pasture-based diet. *Proceedings of the 11th Annual Seminar of the Dairy Cattle Veterinarians Society of the New Zealand Veterinary Association*, p 79–88
- Mertens D R 1997 Creating a system for meeting the fiber requirements of dairy cows. *Journal of Dairy Science* 80:1463–1481
- Meyer R M, Bartley E E, Morrill J L et al 1964 Salivation in cattle. I. Feed and animal factors affecting salivation and its relation to bloat. *Journal of Dairy Science* 47:1339–1345
- Moller S 1997 An evaluation of major nutrients in dairy pasture in New Zealand and their effects on milk production and herd reproductive performance. PhD thesis, Massey University, Palmerston North
- Moller S, Edwards N J, Parker W J et al 1996a Nitrogen application to dairy pasture – the effect of rate and timing of spring nitrogen applications on the concentration of pasture nutrients. *Proceedings of the New Zealand Society of Animal Production* 56:276–279
- Moller S, Parker W J, Edwards N J 1996b. Within-year variation in pasture has implications for dairy cow nutrition. *Proceedings of the New Zealand Grasslands Association* 57:173–177
- Nagaraja T G, Taylor M B, Harmon D L et al 1987 In vitro lactic acid inhibition and alterations in volatile fatty acid production by antimicrobial feed additives. *Journal of Animal Science* 65:1064–1076
- National Research Council 2001 Nutrient Requirements of Dairy Cattle. National Academy Press, Washington DC
- Nilsson S A 1963 Clinical, morphological and experimental studies of laminitis in cattle. *Acta Veterinaria Scandinavica* 4(Suppl 1):9–304
- Norgaard P 1989 The influence of physical form of ration on chewing activity and rumen motility in lactating cows. *Acta Agriculturae Scandinavica* 39:187–202
- O'Connell J, Giller P S, Meaney W 1989 A comparison of dairy cattle behavioural patterns at pasture and during confinement. *Irish Journal of Agricultural Research* 28:65–72
- Peyraud J L, Astigarraga L 1998 Review of the effect of nitrogen fertilization on the chemical composition, intake, digestion and the nutritive value of fresh forage: consequences on animal nutrition and N balance. *Animal Feed Science and Technology* 72:235–259
- Porter J, Lean I J, Chalupa W et al 2001 Effects of nitrogen fertilisation on ryegrass and tall fescue cultivars. Dairy Research Foundation: Current Topics in Dairy Production 6:80–89
- Tranter W P, Morris R S, Williamson N B 1991 A longitudinal study of the hooves of non-lame cows. *New Zealand Veterinary Journal* 39:53–57
- Sauter-Louis C M, Chesterton R N, Pheiffer D U 2004 Behavioural characteristics of dairy cows with lameness in Taranaki, New Zealand. *New Zealand Veterinary Journal* 52(3):103–108
- Tol Van der P P J, Metz J H M, Noordhuizen-Stassen E N et al 2002 The pressure distribution under the bovine claw during square standing on a flat surface substrate. *Journal of Dairy Science* 85:1476–1481

- Tol Van der P P J, Metz J H M, Noordhuizen-Stassen E N et al 2003 The vertical ground reaction force and pressure distribution on claws of dairy cows while walking on a flat substrate. *Journal of Dairy Science* 86:2875–2883
- Tol Van der P P J, Van der Beek S S, Metz J H M et al 2004 The effect of preventive trimming on weight bearing and force balance on the claws of dairy cattle. *Journal of Dairy Science* 86:1732–1738
- Veth De M J, Kolver E S 2001 Digestion of ryegrass in response to change in pH in continuous culture. *Journal of Dairy Science* 84:1449–1457
- Veth De M J, Kolver E S 1999 Pasture digestion in response to change in rumen pH. *Proceedings of the New Zealand Society of Animal Production* 59:66–69
- Veth De M J, Kolver E S 2001 Prediction of rumen pH of dairy cows fed pasture. *Proceedings of the New Zealand Society of Animal Production* 61:241–243
- Visser De H, Valk H, Klop A et al 1997 Nutrient fluxes in splanchnic tissues of dairy cows: Influence of grass quality. *Journal of Dairy Science* 80:1666–1673
- Vuuren Van A M, Krol-Kramer F, Van der Lee R A et al 1992 Protein digestion and intestinal amino acids in dairy cows fed fresh *Lolium perenne* with differing nitrogen contents. *Journal of Dairy Science* 75:2215–2225
- Wales W J, Williams Y J, Doyle P T 2001 Effect of grain supplementation and the provision of chemical or physical fiber on marginal milk production responses of cows grazing perennial ryegrass pastures. *Australian Journal of Experimental Agriculture* 41:465–471
- Westwood C T, Bramley E, Lean I J 2003 Review of the relationship between nutrition and pasture-fed dairy cattle. *New Zealand Veterinary Journal* 51(5):208–218
- Whitely J, Porter J, Lean I J 2000 An evaluation of dry matter production and nutritional value of ryegrass and fescue cultivars assessed under Australian dairy-farming conditions. Report to Dairy Industry Development Corporation, New South Wales
- Wierenga H K 1986 The social behaviour of dairy cows: some differences between pasture and cubicle system. *Proceedings of the International Congress on Applied Ethology of Farm Animals*, p135–138

# Water

### GLOSSARY

**Eutrication:** This is the process by which a body of water becomes rich in dissolved nutrients – either naturally or by pollution.

### KEY CONCEPT

- Water consumption influences dry-matter intake and milk yield.

## THE QUALITY OF DRINKING WATER

The quality of the water supply can affect the absorption of trace elements. High concentrations of minerals or contamination might interfere with absorption of minerals, vitamins, and trace elements from the gastrointestinal tract. Resulting deficiencies seriously compromise claw health.

If the water is obtained from other than municipal or city sources, its quality should be tested every 2 years. The water from deep wells is usually pure enough for livestock consumption, however, it may contain high levels of iron or sulfates. Water obtained from shallow wells, waterways, ponds, or dug-outs may be contaminated with nitrates, chemicals, or organic pollutants. Heavy rainfall can be followed by a rise in water contamination. River water can be contaminated by nitrate from sources upstream on an intermittent basis, therefore, testing every 6 months or before use would be



advisable. Floodwater can sweep away foreign materials from the river banks. Anthrax has been spread in this way.

## Iron

### KEY CONCEPTS

- Water containing more than 0.3ppm of iron should be further investigated if palatability is compromising performance.
- High levels of iron intake can occur from combining sources in water and forage.

High levels of iron in the blood are essential for organisms causing infectious diseases to be successful. Iron in feed or water reduces the absorption of copper, zinc, cobalt, manganese, and selenium. Copper and zinc are essential for the production of healthy horn.

Some districts are known for water containing high levels of iron. Levels as low as 10mg of iron per liter will reduce water intake and milk production. The most usual source of iron in water is from a deep well. High levels of iron in water are reported to have a negative effect on palatability. However, cattle may acclimate to poor-tasting water and thus adjust their consumption.

Another source of iron is also from commercially available micronutrient supplements which invariably contain iron, often as contaminants. Apart from this, iron oxide is sometimes added to give the supplement color as a sales promotion to producers who prefer a colored mix.

All the sources of iron have an additive effect. A high daily iron intake can be tolerated by cattle (1,000ppm), but health may be compromised and the quality of claw horn reduced.

Supplements of vitamin E and zinc tend to reduce the negative (oxidative) effects of excessive iron.

## Calcium

High calcium in drinking water will reduce the absorption of phosphorus, magnesium, manganese, copper, iodine, and zinc. Calcium and magnesium are used in the calculation of water hardness and are reported in equivalent amounts of calcium carbonate.

## Sulfate

The role of sulfate in drinking water is not clearly understood, but if it is too high the consumption of water will likely decline. When sulfate exceeds the upper acceptable limit of 500mg/L, it becomes important to identify the specific salt form of sulfate or sulfur as it is an important determinant of toxicity. At 1,462mg/L, there will be a reduced growth rate, probably associated with a secondary copper deficiency.

Hydrogen sulfide ( $H_2S$ ) is the most toxic form, with concentrations as low as 0.1mg/L causing a reduction in water intake. Common forms of sulfate in water are calcium, iron, magnesium, and sodium salts. All have a laxative effect, with sodium sulfate being the most potent. Sulfates will significantly depress the absorption of copper and may interfere with the absorption of selenium.

There is no simple or inexpensive way to remove sulfate from water or feed.

## Nitrate

Nitrates are broken down in the rumen into nitrites, hydroxylamine, and ammonia. This process does not occur in monogastric species. In a number of European countries, a level of 50mg nitrates per liter of drinking water for human use has been established as the maximum admissible level. Nitrate causes vasodilation and local irritation of the gastrointestinal tract. Chronic nitrate loading can cause disturbance of iodine and vitamin metabolism, reduce weight gain, decrease feed conversion, lower milk yield, cause liver damage, and lower reproductive performance. However, cattle, reportedly, can tolerate levels as high as 200mg of nitrate per liter of drinking water. The generally safe level of nitrate is less than 44mg/L.

Regularly monitoring the nitrate levels in livestock drinking water is extremely prudent. Applications of nitrate fertilizer, together with organic waste from swine, cattle, and poultry cumulatively, can lead to a rise in the nitrate levels in groundwater and wells. Dumping large quantities of raw manure on pastures close to the animal housing is unwise as the levels of nitrate in the pasture can rise considerably. In areas where livestock production is concentrated, it is not unusual to find huge lagoons of manure which are regularly irrigated onto pasture or arable land. If manure is temporarily stored in locations from which run-off can occur, local wells will become contaminated.

It is clear that in the future the storage and disposal of animal waste will become an increasing problem. For this reason, various approaches have been taken to deal

with the problem. In 1995, it was found that 54.1% of dairies in California accomplished some type of solids separation. Only 14.9% of dairies used mechanical solid separation. Separating the solid component of the manure from the liquid part is especially necessary where flush cleansing of barns is practiced. Another approach is on-farm composting of manure. This is labor intensive but has the advantage of generating revenue from the final product which is exported from the farm.

## Herbicides and Pesticides

In regions where these products are used, residues may be found in groundwater. Testing for these agents is very expensive.

## DRINKING BEHAVIOR

### KEY CONCEPTS

- A lack of adequate waterer space and/or insufficient water flow and/or water of poor quality all have negative effects on water intake, thus reducing dry-matter intake and milk production.
- Cows need to drink within 1 hour after milking.
- Adequate water supply is especially important in mixed groups of cows with dominant cows controlling availability of waterer space.
- Water of good quality should be available all of the time.
- It should be possible for 10% of the cattle in a herd to drink at the same time.
- One watering station should be provided for every 15 cows.
- Limit water depth to 15–20cm for fresher water and less debris.
- Provide drains for easy, regular weekly cleansing.

### TECHNICAL COMMENTS

A cow drinks at the rate of 1.0–3.75 gallons (16–17kg) water per minute. A traditional watering bowl delivers water at the rate of only about one gallon (4.5kg) per minute.

A trough perimeter of 24ins (0.62m) must be allowed for 10 cows on low dry-matter feed (when grazing they obtain some of their water from the moisture in the grass as lush grasses may contain as much as 80+% moisture). The same trough perimeter would only be suitable for 6 cows if they were consuming a high dry-matter diet (> 70% DM).

There should be more watering sites:

- if there are a number of heifers in the group.
- if cows are observed waiting in line to drink.
- if the areas around drinking sources are wet, muddy, and/or slippery.
- if ambient temperatures exceed 20°C.
- if waterers are located in narrow crossover alleys.

Placing waterers in crossover alleys, at ends of feed lines, in milking parlor holding areas, and in parlor exit lanes will improve access to water and enhance dry-matter intake. The crossover alleys must be wide enough to allow two cows to pass one another behind an animal drinking at the trough.

Water must be available within 50ft of feed bunk to promote feed intake. However, the closer it is to the feed bunk, the greater the probability will be that it will become contaminated by *Escherichia coli*. This risk is reduced if the waterer is exposed to direct sunlight. However, if the water is exposed to sunlight, the water temperature might increase so that conditions for bacterial growth improve and their population will increase more rapidly. Disinfection by UV in sunlight is effective only at the surface.

Stray voltage decreases water intake.

See Figures 9-1–9-7.



Figure 9-1 Although this watering station provides good perimeter access, it is too low to the ground; the perimeter around is very muddy and should have a concrete apron. (Courtesy of R Acuña)



Figure 9-2 Water troughs should not be too low to the ground or too close to feed bunks, otherwise they will become contaminated with fecal matter. (Courtesy of R Shaver)



Figure 9-3 This water station, located in a crossover alley, is shallow which reduces build-up of debris, yet it is high enough from the ground to permit cows to drink easily. (Courtesy of R Shaver)



Figure 9-4 Regular cleansing of water troughs is essential. Note the large size drainage hole. This crossover alley is wide enough for two cows to pass and is raised to the same level as the stalls. (Courtesy of K Nordlund)



Figure 9-5 Temporary, easily movable water troughs must be made available with adequate delivery of water for cows at pasture. In this case, the tank is located at the electric fence line. (Courtesy of K Nordlund)



**Figure 9-6** This water trough is too deep and has no drainage plug. It will inevitably become heavily contaminated with debris and bacteria. (Courtesy of R Shaver)



**Figure 9-7** A trough located in the middle of a loafing yard increases the risk of social confrontation. In this case, there is also risk from damage caused by contact with unused fence posts. (Courtesy of R Shaver)

## BIBLIOGRAPHY

- Adams R S, Sharpe W E 1995 Water intake and quality for dairy cattle. Penn State Extension Publication DAS 95-8, University Park, PA
- Auverman B W, Sweeten J M 1992 Solids-separation systems for livestock manure wastewater. Summary of demonstration from Southwest dairy field day, Stephenville, TX. Department of Agriculture Engineering, Texas A & M University
- Birnbreier E 1995 Evaluation of knowledge concerning the nitrate/nitrate loading of livestock tolerant concentrations in drinking water. Thesis Tierärztliche Hochschule, Hannover, Germany
- Bridgman S A, Robertson R M P, Syed Q 1995 Outbreak of cryptosporidiosis with a disinfected groundwater supply. *Epidemiology and Infection* 115:555–566
- Castle M E, Thomas T P 1975 The water intake of British Friesian cows on rations containing various forages. *Animal Production* 20:181
- Dado R G, Allen M S 1994 Variations in the relationships among feeding, chewing, and drinking variables for lactating dairy cows. *Journal of Dairy Science* 77:132
- Ensley S M 2000 Relationship of drinking water quality to production and reproduction in dairy herds. PhD Dissertation, Iowa State University
- Goss M J, Barry D A J, Rudolph D L 1998 Contamination in Ontario domestic wells and its association with agriculture: 1. Results from drinking water wells. *Journal of Contaminant Hydrology* 32:267–293
- LeJeune J T, Besser T E, Merrill N L et al 2001 Livestock drinking water microbiology and factors influencing the quality of drinking water offered to cattle. *Journal of Dairy Science* 84:1856–1862
- Lichtenberg E, Shapiro L K 1997 Agriculture and nitrate concentration in Maryland water system wells. *Journal of Environmental Quality* 26:145–153
- Maticic B, Olalla Manas de S F M 1999 The impact of agriculture on ground water quality in Slovenia: standards and strategy. From selected papers presented at a workshop in Albacete, Spain in 1997. Special issue: The use of water in sustainable agriculture. *Agriculture Water Management* 40:235–247
- Moon P E 1997 On-farm composting of manure and livestock. Proceedings of the Northwest Dairy Shortcourse. Washington State University, p 45–52
- Morse D 1997 Alternatives to manure management problems. Proceedings of the 3rd Western Dairy Management Conference, Las Vegas, p 65–68
- Neilsen G H, Culley J L B, Cameron D R 1982 Agriculture and water quality in the Canadian Great Lakes Basin: IV. *Journal of Environmental Quality* 11:493–497
- Pain B F, Hephherd R Q 1980 Benefits of dairy cow waste management systems based on mechanical separation. Livestock waste: a renewable resource. Proceedings of the 4th International Symposium on Livestock Wastes. American Association of Agricultural Engineers, St Joseph, p 422–425
- Wood J A, Anthony D H J 1997 Herbicide contamination of prairie at ultratrace levels of detection. *Journal of Environmental Quality* 26:1308–1318

# Strategic Use of Micronutrient Supplements

## GLOSSARY

**Conditioning:** This is the process by which one trace element influences either negatively (antagonizes) or positively the absorption of another.

**Bioavailability:** This is the term used to describe the proportion of a trace element compound absorbed and biologically available to an animal. The percentage of an element published on the label of a bag of supplements does not necessarily mean that it is available to the animal.

**Protected Minerals:** These are minerals that are combined with organic elements in such a manner that they pass through the rumen and are available to the animal in the small intestine. It is claimed they are absorbed more effectively than inorganic elements which may be bound up in the rumen or intestine in such a manner that absorption is reduced. Protected minerals are particularly useful where there is a marginal deficiency of copper, zinc, and manganese.

**Primary Deficiency:** This is a term used to describe an absolute deficiency of a mineral in the soil and hence diet consumed by the animal. Usually, regions in which primary deficiencies occur are well known to agriculturalists.

**Secondary Deficiencies:** This occurs when there is an adequate or marginal supply of a mineral, but other factors reduce the ability of the animal to absorb the element in question. For example, excess of molybdenum in the diet reduces the availability of copper.

**KEY CONCEPTS**

- All dairy cows require micronutrient supplementation of some kind.
- Supplements should not be used on a hit-or-miss basis.
- Micro/macrominerals available from home-grown products should be assessed.
- Supplements must not be purchased only on the basis of price.
- Inappropriate supplementation can create interactions that will be counterproductive.

**INTRODUCTION**

In order for cattle to remain healthy, a balance must exist between the supply and/or availability of micronutrients and the requirements of the cow. Under conditions of intensive management, both supply and requirement are variable. Therefore, the supply of supplements to cattle can not be an exact science.

An enormous amount of information is available concerning the role and importance of individual micro- and macrominerals as well as vitamins. Fortunately, serious claw problems are unlikely to be caused by a trace element deficiency alone. On the other hand, the marginal intake of trace elements can make a pre-existing claw disorder a greater problem.

Producers, in general, fail to appreciate the value of balanced mineral supplementation and tend to supplement without any rational basis for their action. Some are strongly motivated by the lowest price for which a supplement can be purchased. This is not a problem for a supplier who can easily provide supplements at the 'lowest possible price.' This may mean that some of the ingredients used will have a lower bioavailability than those that are more expensive. In all fairness, there is very little guidance for a strategic approach to trace element supplementation. In one study undertaken by the author, out of 42 beef cattle producers that were surveyed, 35 purchased different formulations.

The somewhat confused and uncertain subject of mineral supplementation has been summarized by two researchers who suggest four key problems associated with trace element supplementation:

1. Trace element requirements are poorly defined, and seldom in cow diets are these requirements altered to fit the level of productivity of the cow.

2. There is considerable variability in the level of trace elements found in forages, and the factors that influence this variability are poorly documented.
3. There is tremendous variability in the trace element content of mineral mixes sold commercially. In fact, it is often difficult to obtain this information – at least through local sales personnel.
4. Never 'shot gun'; that is to say never add additional trace elements to the mineral mix without proper justification.

The practice of 'shot gun' supplementation, that is to say, working on the inappropriate philosophy that 'if a little is good, then more is better,' has a down side. A hit-or-miss approach to mineral supplementation can do more harm than good. Some producers regard supplementation as valueless, while others go to the opposite extreme and offer inappropriate amounts of some products.

**A STRATEGIC APPROACH TO MICRONUTRIENT SUPPLEMENTATION**

There is no universally accepted approach; therefore, until there is one, a simple strategy is recommended:

1. Check the water supply (see Chapter 9). High levels of iron, sulphate, and carbonate can influence the uptake of micronutrients (condition them).
2. Find out from local agricultural consultants if there is a known marginal deficiency of any trace element in the area.
3. Have samples of the total ration tested for its mineral content. This should be done at least every few months as feed ingredients can vary in mineral content. If adequate levels of all minerals are always available to the cattle, very little supplementation may be required.
4. If there is a high incidence of lameness in the herd, it is prudent to increase the levels of copper, zinc, and methionine in the supplement.
5. Almost invariably, cows will require sodium. Intensively managed, high-production cows will require additional zinc to alleviate the effects of stress.

**The Requirement of the Cow**

Calcium, sulfur, copper, zinc, and vitamin A are assumed to be essential for the production of keratin. Stress and pain reduce the reserves of essential elements, particularly zinc, thereby making them less available to the keratogenic tissues. Table 10-1 indicates recommended

**Table 10-1**

RECOMMENDED DIETARY LEVELS OF KEY MINERALS FOR CATTLE	
Mineral	Recommended Level
Calcium	0.30–1.0% DM <sup>a</sup>
Phosphorous	0.35–0.45% DM
Potassium	0.8–2.45% DM
Magnesium	0.25–0.35% DM
Molybdenum	0.5–3.5ppm
Manganese (supplemental)	50–80ppm DM
Cobalt	0.1–1.0ppm DM
Iodine (supplemental)	0.6–2.0ppm DM <sup>b</sup>
Zinc (supplemental)	50–100ppm DM
Copper (supplemental)	10–15ppm DM
Iron	100–500ppm DM
Selenium (supplemental)	0.3–1.0ppm DM <sup>c</sup>

<sup>a</sup>Calcium may need to be higher in pre-freshening diets containing above 1.00ppm.  
<sup>b</sup>Supplemented iodine may result in elevated milk iodine levels.  
<sup>c</sup>Do not exceed the legal limit.

dietary levels of key minerals for cattle. Many of these elements affect some of the enzyme systems that influence the general health of the animal.

### Evaluating the Status of Trace Elements in the Cow

There are no easily available methods of evaluating a marginal mineral deficiency in cattle.

#### Blood Samples

Evaluating trace mineral levels or activity of related enzymes in the blood provides unreliable information, with the exceptions of iron, selenium, and iodine.

#### Liver Biopsy

Tissue samples should never be taken from dead or diseased animals in an attempt to establish mineral adequacy. Taking liver biopsy samples requires skill, is not considered dangerous, and provides the most accurate data. It is a costly procedure, but it is being used routinely in some countries.

The site is the junction of the upper and middle third of the right 11th intercostal space. The area is suitably prepared and a local anesthetic injected. The skin is incised and carried on to enter the peritoneal space. The biopsy instrument is inserted and directed towards the left elbow. When there is resistance to the advance of the instrument, the liver has been reached and a sample can be taken. The wound is then sutured. The risk of complications is minimal.

Liver biopsy levels are considered to be the most reliable method of assessing copper levels in cattle. Adequate levels are reported to be 25–100ppm wet weight. Care must be taken when analyzing results, as liver mineral content varies with stage of life cycle, gestation, stress, and disease.

#### Hair and Horn Samples

Analyzing horn or hair trimmings is of no value as the information is many months out of date and samples are often heavily laden with contaminants. In any case, the mineral content of claw horn is variable, depending on the region from which the sample is taken. Mineral concentrations in claw horn tissue differ significantly between healthy and lame dairy cows. Subjective evaluation of the appearance of the coronary band and claw horn may be useful. If the coronary band is rough and the external surface of the wall is dull, finely striated, or irregular in appearance, it is worthwhile investigating the trace element status of the diet.

### Evaluating Trace Elements in Feed

Total ration testing for micronutrient availability is helpful but often not regarded as being cost effective by producers.

When forages are conserved by the producer, it is essential that home-grown feedstuffs be tested in order to provide a historical record of micronutrient availability on the farm. Unless a problem with the health of the cattle exists, extensive testing is not required. However, it is advisable that a baseline evaluation be made every few years. The availability of trace minerals in plants usually varies from pasture to pasture and from season to season. There is even some variability throughout the season. However, again it must be stressed that although adequate micronutrient levels may be present in a forage it may not necessarily be available to the cow.

Determining trace mineral content of purchased feedstuffs may be of limited value as it can vary substantially from load to load.

Harvesting can cause changes in mineral content. For instance, the iron content of alfalfa or grass silage can vary depending upon harvest conditions or methods. For example, it will be less available:

- if several windrows are raked together prior to chopping.
- if a sickle bar mower or disc mower is used to mow the crop.
- if rain fell on the mowed crop.
- if field conditions were extremely wet or extremely dry.

### The Role of Mineral Elements in Foot Health Zinc

Zinc is probably the most important trace element as it is not only essential in maintaining claw health but also has an extremely wide range of effects on metabolic systems. In addition, it plays a major role in the immune system and with certain reproductive hormones. A deficiency of zinc causes the scaly skin condition called parakeratosis. This observation supports the idea that zinc is involved in speeding skin healing and maintaining cellular integrity. There is also a strong body of evidence suggesting that zinc plays an important role in reducing the incidence of foot rot. Zinc methionine is widely used by producers and appears to increase milk production (by an average of 4%) and improves claw (hoof) quality, decreases somatic cell count, and reduces the incidence of mastitis and other infections during stress. This element has also been shown to decrease the incidence and severity of foot diseases in general.

Marginal levels of zinc occur in the plants of some regions. The dietary zinc requirement varies from 50ppm to 100ppm, depending on the age, level of production, and

stage of the life cycle. High levels of copper, cadmium, calcium, and iron in the diet reduce zinc absorption and interfere with zinc metabolism.

Stress (including intensive management) and pain dramatically increase the animal's demand for zinc, while also depressing its ability to absorb this mineral. This situation is made worse by the fact that zinc is poorly stored in the body. On the other hand, if only zinc levels are increased in nutritional supplements formulated to counteract stressful circumstances, imbalance can result. It has been demonstrated that dietary copper utilization was maximized when the animal was fed a diet with a zinc-to-copper ratio of 4.5:1 vs. 8.2:1 or 1.5:1.

During the close-up dry period and throughout lactation, the demand for zinc by the cow will be higher than normal because of the stresses of intensive management as well as the high zinc requirement for lactation. Therefore, it is wise to increase zinc levels during this period.

If the concentration of zinc from forage is less than 40ppm dry matter, it is wise to increase the zinc levels in the supplement.

### Copper

A deficiency of copper produces noticeable changes in the color of coat hair. It has been established that a copper enzyme increases the structural strength of the keratin filaments of which claw horn is composed. The required dietary content of copper for dairy cattle ranges between 10ppm and 15ppm, depending upon stage of the life cycle.

#### TECHNICAL COMMENTS

In most cases, supplemental copper should be added to the diets at levels not exceeding 16ppm. It may be desirable to increase supplemental levels under the following circumstances:

- Levels of sulfur in the drinking water are high (over 600mg sulfur per liter).
- In pastures or diets contains less than 5ppm dry matter.
- If molybdenum is present in the pasture/forage at levels exceeding 3.0ppm dry matter.
- When the level of sulfur in the total diet exceeds 0.30%.

Other points to be considered:

- High levels of dietary zinc and iron are present in pasture/diet.
- Marginal levels (< 10ppm) of copper in plants occur in many regions of the world. This factor can play a role if the incidence of lameness is high and the true cause is not clear.
- Higher-than-normal levels of sulfur in plants, water, or the dietary supplement can induce copper deficiency.
- Phosphate fertilization decreases the rate of copper uptake by forage plants.
- *Festuca* species are a poor source of copper.
- As little as 300ppm dietary iron can markedly reduce copper absorption.



- Elevated copper (50ppm in feed) reduces the adverse effects of high sulfur (600mg sulfate/L in water or >0.50% in feed) on rumen synthesis of thiamine. However, extreme caution must be exercised when supplementing this high level of copper due to the potential risk of copper toxicity.
- In some pastures there is an excess of molybdenum, the activity of which, as a conditioning agent, can be influenced by the pH of the soil or the species of plants making up the pasture.
- A cow transfers a significant portion of her copper reserves to her calf during pregnancy, especially during late gestation.
- Zinc and iron reduce the availability of copper from plant sources.
- Producers using by-products (i.e., corn gluten products, etc.) need to be aware of sulfur content and adjust the copper levels appropriately.
- Caution must be applied when considering supplementation of elevated levels of copper (> 30ppm in total diet dry matter) as the maximum tolerable level can be as low as 40 ppm of diet dry matter.
- Copper's availability is greatly diminished by sulfur and molybdenum as they form an insoluble complex that renders copper unavailable to the animal.

It should be noted that certain breeds of cattle, such as Jerseys, appear to be more susceptible to copper toxicity.

### **Manganese**

Manganese plays a supportive role in skeletal development and may also be important for proper copper utilization. Manganese is also a required component in functioning of the immune system and cellular protection against superoxide anions. Inadequate levels in the diet are unusual. However, the availability of manganese in feedstuffs and forages is relatively low and is further reduced by adding lime to pastures. The required dietary content of manganese for dairy cattle ranges between 40ppm and 80ppm dry matter. Calcium, potassium, iron, magnesium, phosphorus, and cobalt reduce the availability of manganese.

### **Cobalt**

Cobalt is intimately associated with the production of vitamin B<sub>12</sub>, a deficiency of which is, indirectly, a contributory cause of ketosis. High-producing cows need additional cobalt. Therefore, if grass/forage samples have a content of less than 0.25ppm cobalt supplements should be added. The same would be the case if the soil is extremely alkaline. Supplementation with modest amounts of cobalt may be beneficial in enhancing fiber digestion and appear to have no negative side effects. The recommended dietary content of cobalt for lactating dairy cattle is 0.11ppm. Manganese, zinc, iodine, and monensin may reduce cobalt availability.

### **Iron**

Forage is naturally high in iron. If the level of iron in pasture or forage exceeds 300ppm and the level in water

is abnormally high, there may be a conditioning effect on the uptake of other minerals, particularly copper. It is believed that the use of supplemental vitamin E and zinc will have a beneficial effect by protecting cells against the pro-oxidative effects of excessive iron intake. Unless there is a very specific reason, as in the diets of calves, it may not be necessary to add any supplemental iron. Producers need to be aware that some less expensive phosphorus supplements contain iron as a contaminant. Infectious diseases which cause fever reduce serum iron.

### **Molybdenum**

Molybdenum is the best-known conditioning agent for its role in reducing the availability of copper. It is found at higher levels in legumes than in pasture grasses. Molybdenum, in addition to sulfur, forms a very stable complex with copper, thereby greatly reducing its ability to be absorbed by an animal. If molybdenum is present in the pasture/forage at levels greater than 2.0ppm supplementary copper must be given.

### **Selenium**

Selenium is a conditioning agent for zinc and can occur at toxic levels in some areas. However, some regions of the world have a deficiency of this element. Selenium uptake does not reach its maximum potential unless adequate quantities of vitamin E are provided in the diet.

Fear of white-muscle disease and suppressed immune function tends to encourage producers to oversupplement with selenium. Toxic levels of selenium do cause claw diseases, so it is reasonable to suggest moderation when considering supplementation with this element.

If selenium is present in the diet/forage at levels below 0.25ppm dry matter, a supplement must be given; however, the legal limit for selenium supplementation in the US is 0.3ppm.

### Calcium

Calcium conditions zinc to such an extent that high levels of calcium intake are associated with disorders of the claw capsule. Therefore, for each additional 0.1% calcium in the diet the level of zinc should be raised by 16ppm.

Calcium is an important mineral with respect to the formation of strong keratinized horn tissue. Insufficient calcium provided to the maturing horn-producing cells (keratinocytes) because of an inadequate vascular supply or calcium availability due to hypocalcemia may contribute to the production of low-quality horn. Epidermal cells that are changing into horn are very sensitive to changes in plasma calcium levels. It is suggested that inconsistent levels of calcium around parturition, in particular with the onset of lactation, will certainly influence the metabolism in differentiating epidermal cells. This may provide an explanation for the horn grooves consistently observed associated with calving. A chronic excess of dietary calcium (50–90% alfalfa, in diet) can lead to arrested bone resorption and osteopetrosis.

For maximum yield and fertility, a calcium-to-phosphorus ratio of 1.4–2.0:1 is ideal. In the following circumstances, it may be appropriate to change/increase the calcium/phosphorus content of the supplement:

- for cows in early lactation
- for cows in peak lactation
- where pasture grasses are very low in calcium, i.e., < 1%.

### TECHNICAL COMMENTS

Milk fever is caused by the inability of the cow to mobilize calcium from bone or the intestines in response to the demands of milk production after calving. The following are some the factors that may contribute to precipitating milk fever:

- Excessive dietary potassium during the late dry period (dietary levels > 1.4%).
- Excessive feeding of phosphorus during the late dry period (up to 80g/day).
- Overuse of vitamin D injections during the dry period.
- Low levels of magnesium in the diet (< 0.25% in the ration dry matter).

### Phosphorus

Phosphorus is intimately linked to calcium in the process of bone formation, but it also is important for reproductive efficiency as well as milk yield and growth rate. If there is < 0.3% of calcium or phosphorus available in the diet, special attention should be paid to supplementing these elements. Stress and acidosis reduce the uptake of phosphorus.

Phosphorus is more readily absorbed if it is obtained from animal by-products than it is from plant sources. Inorganic sources are usually used in supplements, but some products contain iron as a contaminant, and this is unsatisfactory if other sources of iron are high.

### Iodine

Iodine is an element essential for regulation of metabolic rate and may play a role in immune response. There is evidence to suggest that feeding high levels of iodine in the form of ethylenediamine dihydroiodide (EDDI) will reduce the incidence of foot rot. In practice, supplementation with EDDI works on some farms but fails on others. In the US, the legal limit is 49.9mg/head/day. However, feeding more than 35mg EDDI per head per day may increase levels of iodine in the milk.

Serum iodine concentrations of 60–80µg/dL are thought to promote an immune response. The required dietary content of iodine for dairy cattle ranges between 0.3ppm and 0.9 ppm, depending upon stage of the life cycle. Soybean, rapeseed, and canola increase iodine requirements of the animal as they contain compounds that reduce iodine availability.

High dietary nitrate inhibits uptake of iodine by the animal.

### Sodium

Sodium is only found at very low levels in many grasses and forages. Sodium, as sodium chloride or common salt, is an essential ingredient of supplements. Cattle tend to crave salt and willingly accept it as rock or block salt – either with iodine added or by itself. The salt component of a trace element supplement makes it attractive to cattle when offered free choice at pasture.

### Magnesium

Magnesium is not an element directly associated with lameness. However, it must be considered when formulating a supplement. A deficiency of this element is responsible for grass tetany (hypomagnesemia). Marginal levels of magnesium have been reported to be associated with reducing calcium mobilization at calving time and contributing to edema (puffiness) of the udder. The clinical form of hypomagnesemia generally arises when grass grows rapidly and is rich in nitrogen and

potassium, particularly if the temperature is below 14°C. Supplementation with magnesium is not essential if grass tetany is not common in the area. However, if the pasture/forage contains less than 0.23% magnesium, magnesium should be added to the supplement. Adding over 2.0% to a free-choice supplement may make it unpalatable and some other method of delivering magnesium should be adopted.

### Grinder/mixers

Mechanical devices are used on some farms to reduce the particle size of some cereal grains. If the machine is of the vertical type, it is unwise to attempt to incorporate a mineral supplement, as it will tend to separate out at the bottom of the mixer. Therefore, supplements should be added to the concentrate and mixed by hand prior to being incorporated into a total mixed ration (TMR).

### Vitamins

#### Vitamin A

Vitamin A does play a role in maintaining the health of skin and hair; therefore, it is not unreasonable to suppose that it plays a part in good-quality horn production. However, a deficiency in cattle grazing lush green pasture is unlikely. Supplementing diets of dairy cattle consuming stored feeds is recommended. It is common for these diets to be supplemented with 100,000–125,000 IU/hd/d.

#### Vitamin D

Vitamin D stimulates the absorption of calcium and phosphorus from the intestine. It is abundant in fresh grasses. However, housed cattle should be given a supplement of 25,000–30,000 IU D<sub>3</sub> per cow/per day.

#### Vitamin E

Vitamin E deteriorates in forage that has been stored for any length of time and grains are a poor source of the vitamin. Cattle consuming significant amounts of lush green forage do not require supplementary vitamin E. However, if there is a history of white muscle disease or the water contains a high level of iron, the amount of vitamin E in the supplement should be doubled.

#### Biotin

Reports indicate that biotin improves the integrity of claw horn in cattle. In one study, it was found that beef cattle receiving a supplement of biotin were 2.5× less likely to have sandcracks than those receiving no supplement. It also has been suggested that biotin supplementation can improve milk yield.

If there are serious lameness problems in the herd, the addition of biotin to the supplement is warranted. However, the addition of this supplement will not be effective unless the nutritional and management errors are corrected.

The addition of biotin at the rate of 10mg/day to a supplement for heifers should always be considered if lameness problems with heifers are significant, particularly if they are calving at 24 or less months of age.

## COMMENTS ON FORMULATING A MICRONUTRIENT SUPPLEMENT

### KEY CONCEPTS

- All cows require some micronutrient supplements.
- All cows do not need every micronutrient available.
- If a little is useful, it does not mean that more is better.
- Buy cheap and you get what you pay for.
- Too much of one element can reduce the effectiveness of other elements.

Cows will be required to consume at least 100g of supplement each day. The active ingredients will be mixed with a 'filler' (ground cereal). For beef cattle, the mix is offered free choice in troughs protected from the rain. The salt component of the product makes it attractive to the animals. Free choice gives the producer an opportunity to monitor the overall amount of supplement used. There is, of course, no guarantee that every cow will consume equal amounts. Variations in the rate of consumption do occur and this is indicative of changes in the quality of pasture. It also reflects an increased or decreased craving for sodium. For this reason, the availability of a salt block should be considered as a means of stabilizing supplement consumption if necessary.

In the case of dairy cows the supplement may be mixed with the concentrate. The amount of product will vary considerably in accordance with the amount of feed consumed. Hypothetically, this will mean that some cows will receive too much supplement and others too little, depending on the stage of lactation. Cows in peak lactation require more sodium and calcium than

do dry cows and heifers. Different management strategies should be considered to overcome this problem.

If a lameness problem does not exist on a farm and no other significant health problem has been reported, the basic formula for the supplement should be kept as simple as possible. Feed-testing laboratories often have summaries of the nutrient content of feedstuffs grown in their service area. The professional people associated with these laboratories can provide valuable resource information.

If lameness or a health problem does exist, an investigation of the mineral profile of the feedstuffs grown on the farm should be undertaken. The mineral content of cereals is much less variable than it is for forages or pasture crops. However, the mineral content of oilseed and cereal co-products can vary widely. Unfortunately, testing plants for mineral content is not straight forward. For grazing cattle, testing should commence in the spring. Several samples must be taken from any given crop, and each plant source (pasture/field) should be tested separately. It should be noted that cattle are selective grazers and choose the lushest parts of the plant available. Therefore, samples should contain more leaf than stem. For confined cattle, testing of forage should be continued year round.

If the initial pasture samples *all* show mineral levels well within the normal range, further testing may not be needed. If any minerals are present close to marginal levels or below acceptable levels, complete sampling should be repeated 8–12 weeks later.

In instances where it is reasonable to suspect that a mineral imbalance exists on a farm, it is wise to take a few soil samples and have them tested for mineral element content.

## BIBLIOGRAPHY

- Baggot D G, Bunch K J, Grill G R 1988 Variations in some inorganic components and physical properties of claw keratin associated with claw disease in the British Friesian cow. *British Veterinary Journal* 144:534–542
- Ballentine H T, Socha M T, Tomlinson A B et al 2002 Effects of feeding complexed zinc, manganese, copper and cobalt to late gestation and lact dairy cows on claw integrity, reproduction and lactation performance. *Professional Animal Science* 18:211–218
- Berg J N, Maas J P, Paterson J A 1984 Efficacy of ethylenediamine dihydroiodide as an agent to prevent experimentally induced bovine foot rot. *American Journal of Veterinary Research* 46(6):1073
- Bergsten C, Greenough P R, Seymour W 2002 Effects of biotin supplementation on performance and claw lesions in dairy cows. *Proceedings of the XIIIth International Symposium on Lameness in Ruminants, Orlando*, p 241–243
- Bergsten C, Greenough P R, Dobson R C 1999 A controlled field trial of the effects of biotin supplementation on milk production and hoof lesions. *Journal of Dairy Science* (Suppl 1):34(Abstr)
- Brazle F K 1993 The effect of zinc methionine in a mineral mixture on gain and incidences of foot rot on steers grazing native grass pastures. *Journal of Animal Science* 71(Suppl 1):40(Abstr)
- Campbell M H, Miller J K 1998 Effect of supplemental dietary vitamin E and zinc on reproductive performance of dairy cows and heifers fed excess iron. *Journal of Dairy Science* 81:2693–2699
- Campbell J R, Greenough P R, Petrie L 2000 The effects of dietary biotin supplementation on vertical fissures of the claw wall in beef cattle. *Canadian Veterinary Journal* 41:690–694
- Cousins R J 1996 Zinc. In: Ziegler E E, Filer J J Jr (eds) *Present knowledge of nutrition*, 7th edn. ILSI Press, Washington, p 293–306
- DePeters E J, Fadel J G, Arana M J et al 2000 Variability in the chemical composition of seventeen selected by-product feedstuffs used by California dairy industry. *Professional Animal Scientist* 16:69–99
- Fitzgerald T, Norton B W, Elliot R et al 2000 The influence of long-term supplementation with biotin on the prevention of lameness in pasture fed dairy cows. *Journal of Dairy Science* 83:338–344
- Hedges J, Blowey R W, Packingham A J et al 2001 A longitudinal field trial of the effect of biotin on lameness in dairy cows. *Journal of Dairy Science* 84:1969–1975
- Horst R L 1986 Regulation of calcium and phosphorus homeostasis in dairy cows. *Journal of Dairy Science* 69:604–616
- Larson L L, Owen F, Cole G P et al 1980 Relation of periparturient administration of selenium and vitamins to health status in dairy cattle. *Journal of Animal Science* 51(Suppl 1):296 (Abstr)
- Maas J, Davis L E, Hempstead C et al 1984 Efficacy of ethylenediamine dihydroiodide in the prevention of naturally occurring foot rot in cattle. *American Journal of Veterinary Research* 45(11):2347
- Midla L T, Hoblet K H, Weiss W P et al 1998 Supplemental dietary biotin for prevention of lesions associated with septic subclinical laminitis (pododermatitis asceptic diffusa) in primiparous cows. *American Journal of Veterinary Research* 59:733–738
- Moore C L, Walker PM, Jones M A et al 1988 Zinc methionene supplementation for dairy cows. *Journal of Dairy Science* 71(Suppl):152(Abstr)
- Mülling C K W, Brugulla H H, Reese S et al 1999 How structures in bovine hoof epidermis are influenced by nutritional factors. *Anatomy Histology and Embryology* 28:103–108
- National Research Council 2001 *Nutrient requirements of dairy cattle*, 7th rev. edn. National Academy of Science, Washington

- Preston R L, Bartle S J, Siddiqui M M 1993 Texas Technical Research Results, Lubbock
- Puls R 1994 Mineral levels in animal health. In: Diagnostic data, 2nd edn. Sherpa International, Clearbrook
- Wedekind K J, Hortin A E, Baker D H 1992 Methodology for assessing zinc bioavailability, efficiency estimates for zinc methionine, zinc sulphate and zinc oxide. *Journal of Animal Science* 70:178–187
- Wellington B K, Patterson J A, Swenson C K et al 1998 The influence of supplemental copper and zinc on beef heifer performance and changes in liver copper. *Proceedings of the Western Section of the American Society of Animal Science* 49:323
- Westra R 1981 Hoof problems in cattle. Is there a relationship with trace mineral levels? *Proceedings of the 11nd Western Nutrition Conference, Edmonton*, p 115–132

# Rearing Replacement Stock

## INTRODUCTION

### KEY CONCEPTS

- If a herd has a lameness problem and the prevalence of foot lesions in first-lactation heifers is high, first calving should never be allowed before 24 months of age.
- 20% of the cost of a dairy operation is bound up in rearing replacement heifers.
- The period from birth to calving is the most unproductive period in the life of a dairy cow.
- Heifers with an average daily weight gain of more than 1.8lb (0.8kg) before calving are at an increased risk of sole hemorrhage and subclinical laminitis.

In the 1960s, the majority of dairy heifers calved when they were 36 months of age. Today, in high-yielding Holstein herds (>22,000lb milk per year), heifers typically conceive at 16 months of age weighing 910lb (413kg), and calve at 25 months – weighing at least 1,360lb (618kg) before calving. These data indicate an average overall daily weight gain of 1.8lb (0.818kg), with an average daily weight gain of 1.6lb (0.727kg) during pregnancy.

A high prevalence of hemorrhages in the soles of the claws is now widely accepted as a clinical sign of subclinical laminitis (SCL). However, sole hemorrhages are extremely difficult to differentiate from bruising (see p. 41). Therefore, it is preferable that the diagnosis of SCL in a herd should first be confirmed by finding lesions of toe and sole ulcer and/or white line disease.

More and more reports are being published of instances in which first-lactation heifers have a higher prevalence of sole hemorrhages than do the mature cows in a herd. Trauma, as occurs when heifers are first introduced to hard surfaces, increases the prevalence of hemorrhages considerably. This factor must be considered when determining the importance of hemorrhages. Therefore, before proceeding to look at other possible risk factors, it is wise to investigate changes in management that may have suddenly exposed the animal's feet to trauma.

Nevertheless, in many instances, the hemorrhages are quite severe immediately after calving and lameness, producing lesions by 75 days postpartum. It is believed that sole hemorrhages related to SCL are not visible on the surface of the sole until 8–10 weeks after the insult causing them takes place. For example, this would indicate that hemorrhages seen immediately after calving had their origins somewhere in late pregnancy.

An unusually high prevalence of hemorrhages in the soles of heifers' claws could be caused by:

- the stress of social interaction
- sudden changes in diet during the peripartum period



**Figure 11-1** These are the claws of a heifer photographed 2 months (70 days) after calving. A sole ulcer is present in the lateral claw and a hemorrhage in the medial claw. The heel bulbs have started to disintegrate.

- sudden reduction of exercise during the adaptation period
- high average daily weight gain
- accelerated puberty.

The reader is recommended to consult Figures 4-12, 4-13 and 4-14 as this series of illustration demonstrates how SCL haemorrhage can progress prior to calving. See also Figure 11-1.

## EARLY CALVING

Some agricultural economists argue that the earlier a heifer calves the greater will be the economic reward. Logical as this argument may be, no information correlating first calving to survival rate is presented. The dairy industry is very concerned that the longevity of dairy cows is not as it should be. However, there is no evidence to refute the possibility that a heifer calving before she has reached 26 months of age will not live as long or have as good foot health as an animal calving after she has reached 26 months of age. One report asserts that SCL is rarely seen in animals that calve for the first time when they are 27 months of age.

The first 26 months in the life of a cow is a busy period for hormone activity and physiological change. Starting even before the signs of puberty are obvious, the level of sex hormones steadily increases. One of the functions of these hormones is to slow down the growth of long bones. In other words, the sexuality of an animal can, in some instances, be related to its height. Taking steps to advance puberty in order to breed the animal so it will calve at an earlier age can affect its height. This in turn affects the rationale for breeding heifers when they reach an optimal height at the withers. Each animal has a natural, genetic potential for stature, therefore, it is arguable that attempting to manipulate puberty has conflicting perspectives.

Also, during the first 26 months of a cow's life, growth hormones have a dominating influence. However, by the time a modern heifer calves, she has reached less than 80% of the body weight of a mature cow. It is not known at what age the claws of a heifer cease growing. It is not even known if animals with large feet are more prone to lameness than are animals with small feet.

This discussion would be incomplete if no mention was made of the hormonal activity specific to the period around calving. Recent reports propose that some of the changes associated with laminitis are controlled to some extent by parturient hormones, particularly relaxin. To what extent these hormones interact with other hormonal activities in the young heifer's body is

not known. However, it is during the period leading up to and around calving that hormone activity will be most intense. This period coincides with the time when a heifer is likely to encounter trauma due to her first contact with concrete, she will experience social confrontation, and there will be dramatic changes in her diet.

The foregoing discussion should not be interpreted as an outright condemnation of early calving. If the cause of first lameness during first lactation cannot be identified then the calving and rearing protocols are likely to be implicated. Furthermore, should the cause of lameness in all of the cows in a herd tend to be elusive, then it is probably appropriate to review the various parameters of the heifer rearing program.

## WEIGHT AND WEIGHT GAIN

### KEY CONCEPTS

- An optimal body weight is only attainable without compromising the animal's health and productivity if the (frame) size of the animal is also optimal.
- Three to ten months of age is a critical time for mammary development; therefore, average daily weight gain should not exceed 1.8lb (0.8kg) during this period.

**Table 11-1**

GROWTH GOALS AND RECOMMENDATIONS FOR FEEDING HOLSTEIN HEIFER *AD LIBITUM* (VandeHaar, 1998)

Age (months)	Weight lb (kg)	Gain lb/day (cm)	Withers Height (ins)	ME <sup>a</sup> (Mcal/lb)	NE <sub>m</sub> <sup>b</sup>	CP <sup>c</sup> %	CP:ME <sup>d</sup> (g/Mcal)
2	167	1.76	34.1	1.33	0.80	19.3	66
4	279	1.96	37.6	1.27	0.76	18.4	66
6	398 (180)	2.00 (0.9)	40.8	1.18	0.71	17.1	66
8	517 (235)	1.97 (0.89)	43.9	1.12	0.67	15.5	63
10	634 (288)	1.93 (0.87)	46.7	1.12	0.67	15.5	63
12	748 (340)	1.89 (0.85)	48.7	1.08	0.65	14.3	60
14	860 (390)	1.84 (0.83)	50.4	1.08	0.65	14.3	60
16	970 (440)	1.81 (0.81)	51.7	1.08	0.65	13.3	56
18	1,077 (489)	1.79 (0.81)	52.8	1.08	0.65	13.3	56
20	1,184 (538)	1.76 (0.80)	53.8	1.08	0.65	13.3	56
22	1,290 (586)	1.76 (0.80)	54.8	1.08	0.65	13.3	56
23	1,343 (610)	1.76 (0.80)	55.2	1.08	0.65	13.3	56
24 Pre-calf	1,400 (636)		55.6	1.20	0.72	15.8	60
24 Post-calf	1,250 (568)		55.6	1.30	0.78	18.0	63

<sup>a</sup>Concentration of metabolizable energy in diets. ME is approximately NE<sub>m</sub> divided by 0.6.

<sup>b</sup>Concentration of net energy for maintenance in diets. NE<sub>gain</sub> is approximately 0.66 times NE<sub>m</sub>.

<sup>c</sup>Concentration of crude protein in diets. Special protein sources high in undegraded protein likely are not needed in most heifer diets. Most of the supplemental CP should come from protein sources such as legume forages and soya bean meal; however, urea could be used in limited amounts as long as the rumen-undegraded protein was 25–35% of the total CP.

<sup>d</sup>Recommended ratio of CP to ME in heifer diets. To calculate this ratio, multiply Mcal ME/lb by 2.2 to give Mcal ME/kg. Then multiply % CP by 10 and divide by Mcal ME/kg. At 66g/Mcal, about 26% of dietary calories are from protein.



The optimal body weight of a heifer after calving (see Table 11-1) is believed to be 1,250lb (568kg). Lighter body weights result in lower milk production. Heavier weights often involve problems with fat mobilization associated with a greater incidence of dystocia, ketosis, and mastitis in the first month after calving. For this reason, the evaluation of body fat is essential. The optimal body condition score is considered to be 3.0–3.5.

If the post-calving weight is 1,250lb (568kg), the pre-calving weight will be about 1,415lb (643kg). This pre-calving weight can only be achieved with an average daily weight gain of 1.9lb (0.86kg) at 24 months or 1.8lb (0.81kg) at 25 months.

The size of an animal is, in dairy cattle, factored as stature in which height at the withers is related to the animal's weight. The optimal height at the withers at first calving is 54–56ins (135–140cm). A less-used criterion is frame size, which includes body length measured from the point of the shoulder to the pin bone (*tuber ischiadicum*). Optimal body length at calving is 66–68ins (165–170cm).

The following are usual parameters of pre-calving growth:

- *Birth to 3 months of age.* Average daily weight gains are low during the first 3 months of life.
- *3–6 months of age.* Calves should be fed about 66g of crude protein for each Mcal.
- *6–12 months of age.* The ratio should be dropped to 60g crude protein for every Mcal of energy. The ratio can be dropped to 55g/Mcal 2 months before breeding in order to maintain a high rate of conception.
- *7 months to puberty.* A high-energy or rapid growth-promoting diet fed during this period may reduce the amount of mammary tissue present at calving. Particular care must be taken if corn silage is fed to growing heifers to ensure that adequate protein supplementation is added to the diet.

Ideally, Holstein heifers should not be bred until they weigh 950lb (430kg) and are 51ins (125cm) high at the withers. If bred at this optimal weight and height, the milk yield will not be affected negatively, even if daily weight gains are relatively high during pregnancy in order to attain the target weight at calving.

The foregoing observations are guidelines based on research findings. Accelerated puberty, higher growth rates, and earlier calving can be achieved, but the wisdom of this practice is questionable (see p. 135).

## SOCIAL CONFRONTATION

### KEY CONCEPT

- Current opinion favors the concept that social confrontation – the interaction between dominant and submissive animals – should be considered to be a stressor (see p. 71).

Cattle, like humans, need to have personal space. With animals, this phenomenon is usually referred to as the 'flight zone.' As an animal ages and gains experience in social interaction, the flight zone becomes smaller. In addition to the age factor, there is an order of genetic dominance in any group of animals. This genetic factor may override the urges of the flight zone. Naive heifers tend to fall low in the order of dominance, with the result that they require more bunk space, more opportunities to enter a stall, and uninhibited access to water.

Social confrontation severely limits a young animal's ability to rest and they are found to suffer from an increase prevalence of claw damage. Confrontation can be limited if recently calved cows and heifers are mixed into the milk herd during the hours of darkness. In principle, as little competition as possible is the ideal scenario for the first 3–4 weeks after calving.

## HEIFER NUTRITION (also see Chapter 5)

### KEY CONCEPTS

- Do not assign the poorest-quality forages to heifer rations.
- Avoid exclusively feeding corn silage to heifers, particularly if it is not adequately supplemented with protein.
- If an energy-rich ration is to be fed to heifers, the quality of the fiber must be high.
- The period of lead feeding should be more gradual and last longer for heifers than for mature animals.
- Intake of carbohydrates may need to be restricted to avoid excess conditioning.
- In large herds, heifers should be managed as a separate milking group.
- In small herds, several heifers at a time should be mixed with mature animals.

**EXERCISE (p. 47) AND FLOORING (p. 78)****KEY CONCEPTS**

- Sudden reduction of freedom to exercise during the period when a heifer is first exposed to concrete surfaces must be avoided, particularly if, simultaneously, social confrontation is taking place.
- The manner in which young stock is introduced to hard floor surfaces is sometimes of greater importance than the diet they are being offered.
- The incidence of laminitis among primiparous cows is higher when little or no bedding material is used in cubicles than when large amounts of bedding are used.

The pumping action of the coronary cushion (p. 19) depends on the freedom of a heifer to move around. Blood does not circulate through the feet of a stationary animal as it does in the feet of one free to move. Usually, during the immediate pre-calving period, heifers have unlimited opportunities for exercise. As the time of parturition approaches, it is a common practice to suddenly reduce freedom of movement in order to prepare the animals to enter the milking herd.

It has been found that calves reared on unyielding flooring surfaces have more sole hemorrhages. Heifers reared on soft surfaces and then suddenly introduced to concrete surfaces when entering the milking herd may be more susceptible to sole lesions. This may be because the digital cushion is not fully developed at the time of first calving (see p. 20). Therefore, it is argued that there is a need for external shock absorption such as good bedding. There is also evidence to support the practice of using rubber mats in stalls to be used by heifers during their first lactation.

Heifers managed on dry lots have fewer sole hemorrhages than those housed indoors on concrete surfaces. More farmers in the UK are housing their cows in straw yards for 3–6 weeks after calving before releasing them back into the loose housing system with cubicles. A further refinement in this way of management is to house heifers with dry cows for 1–3 weeks before calving. This allows the heifers to become partially established in the 'pecking order' and provides them with a straw-bedded lying area and a concrete feeding area. In this way, they begin to accustom their feet to the concrete floor.

In the most modern systems, heifers are provided with individual feeding spaces in addition to their conventional lying spaces. The system is claimed to have produced good results in regard to a low incidence of sole ulcers and heel horn erosion, and appears to improve the behavior at the mangers.

Weight-bearing before heifers calve for the first time is either equally distributed over the medial and lateral claws or more weight is borne on the medial claw. During the first lactation, weight-bearing is transferred to the lateral claw. Thereafter, more severe lesions are then found in the lateral than the medial claw. The reason for this is probably the development of a large, tight udder.

**REARING BEEF BULLS**

The practice of 'fitting' young beef bulls is common in some countries. The animals are intensively fed from the age of about 10 months in order to attain the maximum body weight possible for bull sales held in anticipation of the breeding season. It has been possible to make controlled studies of this practice in special bull-testing stations. In such trials, it was found that a high percentage of the animals with the highest average daily weight gain were culled for 'feet and legs.' Necropsy findings revealed that laminitis-like lesions were present. Whether the cause was solely nutritional or due to excessive weight of the animals was not determined.

Bulls being prepared for a livestock show sometimes have 'puffy feet' (see p. 38) which is an indication of an animal's inability to acclimate to a very high concentrate intake.

It is recommended that care should be taken in feeding young bulls as nutritional management can adversely affect foot health.

**BIBLIOGRAPHY**

- Albutt R W, Dumelow J, Cermak J P et al 1990 Slip-resistance of solid concrete floors in cattle buildings. *Journal of Agricultural Engineering Research* 45:137–147
- Amburgh Van M E, Galton D M, Bauman D E et al 1998 Effect of three prepubertal body growth rates on performance of Holstein heifers during first lactation. *Journal of Dairy Science* 81:527–538
- Barnes M M 1989 Update on dairy cow housing with particular reference to flooring. *British Veterinary Journal* 145:436–445
- Berg J N, Butterfield R M 1973 *New concepts of cattle growth*. John Wiley, New York
- Bergsten C 1994 Haemorrhages of the sole horn of dairy cows as a retrospective indicator of laminitis: an epidemiological study. *Acta Veterinaria Scandinavica* 35:55–66

- Bergsten C 2003 Separate feeding cubicles in loose housing system. *VL-Tidningen* 3:22–25
- Bergsten C, Frank B 1996 Sole haemorrhages in tied first calving heifers as an indicator periparturitional laminitis. Effects of diet, flooring and season. *Acta Veterinaria Scandinavica* 37:383–394
- Blowey R W 1993 Solar haemorrhages in dairy cattle. *Veterinary Record* 132:663
- Bonsma J C 1973 In: Cunha T J, Warwick A C, Kroget A C (eds) Factors affecting the calf crop. University of Florida Press, Miami, p 197–231
- Capuco A V, Smith J J, Waldo D R et al 1995 Influence of prepubertal dietary regimen on mammary growth of Holstein heifers. *Journal of Dairy Science* 78:2709–2725
- Colam-Ainsworth P, Lunn G A, Thomas R C et al 1989 Behaviour of cows in cubicles and its possible relationship with laminitis in replacement dairy heifers. *Veterinary Record* 125:573–575
- Faye B, Lescourret F 1997 Environmental factors associated with lameness in dairy cattle. *Preventive Veterinary Medicine* 7:267–287
- Frankena K, van Keulen K A S, Noordhuizen J P et al 1992 A cross-sectional study into prevalence and risk indicators of digital haemorrhages in female dairy calves. *Preventive Veterinary Medicine* 14:1–12
- Gill G S, Allaire F R 1976 Relationship of age at first calving, days open, days dry and herd life to a profit function for dairy cattle. *Journal of Dairy Science* 59:1131–1139
- Greenough P R, Vermunt J J 1991 Evaluation of sub-clinical laminitis in a dairy herd and observations on associated nutritional and management factors. *Veterinary Record* 128:11–17
- Grummer R R, Hoffman P C, Luck M L et al 1995 Effects of prepartum and postpartum dietary energy on growth and lactation of primiparous cows. *Journal of Dairy Science* 78:172
- Hendry K A K, MacCallum A J, Knight C H et al 1999 Effect of endocrine and paracrine factors on protein synthesis and cell proliferation in bovine hoof tissue culture. *Journal of Dairy Research* 66:23–33
- Hendry K A K, MacCallum A J, Knight C H et al 1997 Laminitis in the dairy cow: a cell biological approach. *Journal of Dairy Research* 64:475–486
- Henrichs A J, Hargrove G L 1987 Standards of weight and height for Holstein Heifers. *Journal of Dairy Science* 70:653–660
- Henrichs A J 1993 Raising dairy replacements to meet the needs of the 21st century. *Journal of Dairy Science* 76:653
- Hirst W M, Murray R D, Ward W R et al 2002 A mixed-event time-to-event analysis of the relationship between first lactation lameness and subsequent lameness in dairy cows in the UK. *Preventive Veterinary Medicine* 54:191–201
- Hoffman P C 1997 Nutrition and environment – improving heifer growth. In: Proceedings of the Eighteenth Western Nutrition Conference, Winnipeg, p 23–27
- Hoffman P C, Funk D A 1992 Applied dynamics of dairy replacement growth and management. *Journal of Dairy Science* 75:2504
- Hoffman P C 1997 Optimal body size of Holstein replacement heifers. *Journal of Animal Science* 75:836–845
- Hoffman P C 1996 Optimum growth rates for Holstein replacement heifers. Proceedings of the Calves, Heifers and Dairy Profitability Conference. Northeast Regional Planning Services, NRAES-74, p 25
- Hultgren J, Bergsten C 2001 Effects of rubber slatted flooring for tied dairy cows on animal cleanliness and foot health in tied dairy cows. *Preventive Veterinary Medicine* 52:75–89
- Keown J F, Everett R W 1986 Effect of days carried calf, days dry, and weight of first calf heifers on yield. *Journal of Dairy Science* 69:1891
- Lacasse P, Peticlere D 1995 Replacement heifers: feeding for mammary gland development. In: Proceeding of Advances in Dairy Technology, Western Canadian Dairy Seminar, Red Deer, p 25–45
- Leonard N, O'Connell J, O'Farrell K 1992 The effect of cubicle design on behaviour and foot lesions in a group of in-calf heifers: preliminary findings. Proceedings of the VIth International Symposium on Disorders of the Ruminant Digit, Rebuild, p 29
- Leonard F C, O'Connell J, O'Farrell K 1994 Effect of different housing conditions on behaviour and foot lesions in Friesian heifers. *Veterinary Record* 134:490
- Leonard F C, O'Connell J M, O'Farrell K J 1996 Effect of overcrowding on claw health in first-calved Friesian heifers. *British Veterinary Journal* 152:459–472
- Little W, Kay R M 1979 The effects of rapid rearing and early calving on the subsequent performance of dairy heifers. *Animal Production* 29:131–142
- Manske T, Hultgren J, Bergsten C 2002 Prevalence and interrelationships of hoof lesions and lameness in Swedish dairy cows. *Preventive Veterinary Medicine* 54:247–263
- Maton A 1987 The influence of the housing system on claw disorders with dairy cows. In: Wierenga H K, Peterse D J (eds) Cattle housing systems, lameness and behaviour. Martinus Nijhoff Publishers, Boston, p 151–158
- Mitchell C D 1974 Are the passageways in your cubicle building too slippery? *Farm Building Progress* 37:17–20
- Morris I D, Phillips C J C 1993 The effect of floor covering on bovine locomotion. Proceedings of the 27th Congress of the ISAE Berlin, p 452–454
- Morris I D, Phillips C J C 1994 An investigation into the walking behaviour of dairy cows on four different flooring surfaces. Proceedings of the 28th Congress of the ISAE, Foulum, p 165
- Moser E A, Divers T J 1987 Laminitis and decreased milk production in first-lactation cows improperly fed a dairy ration. *Journal of the American Veterinary Medical Association* 190:1575–1576
- Ossent P, Peterse D J, Schamhardy H C 1987 Distribution of load between the medial and lateral hoof of the bovine hind limb. *Journal of Veterinary Medicine* 34:296–300
- Peterse D J, Van Vuuren A M 1984 The influence of a slow or rapid concentrate increase on the incidence of foot lesions in freshly calved heifers. Proceedings of the European Association on Animal Production Congress, The Hague, the Netherlands

- Quigley J D 1997 Management of dairy replacement calves from weaning to calving. Proceedings of Advances in Dairy Technology, Western Canadian Dairy Seminar, Red Deer, p 7–22
- Raeber M, Scheeder M R L, Geyer H et al 2002 The influence of load and age on the fat content and the fatty acid profile of the bovine digital cushion. Proceedings of the XIIIth International Symposium on Lameness in Ruminants, Orlando, p 194–198
- Russell A M, Rowlands G J, Shaw S R et al 1982 Survey of lameness in British dairy cattle. Veterinary Record 111:155–160
- Sejrsen K, Purup S 1997 Influence of prepubertal feeding level on milk yield potential of dairy heifers: a review. Journal of Animal Science 75:828–835
- Valentine S C, Dobos R C, Lewis P A et al 1987 Effect of live-weight gain before or during pregnancy on mammary gland development and subsequent milk production of Australian Holstein-Friesian heifers. Australian Journal of Experimental Agriculture 27:195
- VandeHaar M J 1998 Accelerated heifer growth: truth or consequences. Proceedings Tri-State Dairy Nutrition Conference, Fort Wayne
- Vermunt J J, Greenough P R 1996 Sole haemorrhages in dairy herds managed under different underfoot and environmental conditions. British Veterinary Journal 152:57–73

# Genetic Selection and Conformation

## GLOSSARY

**Conformation:** This describes 'the shape or proportionate dimensions of an animal.'

**Type:** This is used, by the dairy industry, to refer to conformation.

**Linear-type Trait:** This is a characteristic of conformation measured subjectively on a scale of 1–9 (or 1–50). 'Linear' when used by the beef industry, tends to mean a measure of conformation between two anatomical points.

**Functional Non-Production Traits (NPTs):** These are any functional characteristic of the animal that is attributable to maintaining health.

## KEY CONCEPTS

- Single-trait selection for production has a negative long-term effect on functional non-production traits such as feet and legs.
- Type evaluation conducted by a national Holstein breed association has significant, positive value and must not be confused with judging animals in a show ring.

## INTRODUCTION

The milk yield of intensively managed, high-production Holstein dairy cows has probably doubled in the lifetime of most contemporary dairy farmers. At the same time, the functional life of the same dairy cows has become shorter and is now recognized as being economically unacceptable. Some workers have postulated that:

*'high production cows in an environment of intensive management are on the verge of failing to attain their genetic potential for production.'*

It is suggested that this has resulted from years of selecting dairy cattle mainly for their milking potential and at the same time neglecting selection for functional efficiency. One factor defining functional efficiency is reproductive performance. Reproductive efficiency has been shown to be declining in some countries. In Ireland, this is attributed partly to the selection for higher milk production at the expense of functional traits. Another cause for culling and reduced milk production is lameness. Lameness and reproductive inefficiency have been linked (p. 4) to have common etiological patterns.

Lameness has been shown to be more prevalent in cows with poor conformation, particularly of the hindlimbs and the feet. In this chapter, traits of conformation will be discussed from the perspective of how they may be changed by such factors as heifer management, early calving, nutrition, laminitis, age, flooring systems, and claw trimming. A broad understanding of the parameters of a trait will improve methods by which it can be evaluated as well as increase the confidence of the user.

The international associations of breeders of Holstein (Friesian) cattle have made commendable progress in developing a sophisticated system for selecting dairy cows. This system provides an excellent basis for discussing foot health.

## AN OVERVIEW OF THE PROBLEMS AND MISUNDERSTANDINGS ASSOCIATED WITH FOOT HEALTH

Research workers are required to manipulate a crippling array of variables and risk factors. This problem should be addressed through a multidisciplinary approach. This is often difficult because everyone concerned (geneticists, nutritionists, physiologists, animal health scientists, claw trimmers, and practicing veterinarians) tends to work within their own area of expertise. Important developments in one discipline may go unnoticed by workers in a parallel discipline. This results in flaws in the data used and uncertainty regarding the credibility of the conclusions reached from mass statistical analysis.

Lameness is not a disease, but a clinical sign of a lesion or disorder. The disorders that can produce lesions causing 'lameness' fall into three groups: infection, metabolic disturbance, and/or trauma. It is probable that different genomes are implicated in each of these groups. This means that caution should be exercised when making general statements about the heritability of lameness. For example, it has not been demonstrated that subclinical laminitis is heritable in Holstein cattle. However, in a herd where laminitis is prevalent, not every cow will be affected equally, given a level playing field of variables. Whether or not there is a genetic component to the stability of a cow's metabolism is unclear. Nevertheless, this thought should be kept in perspective while linear traits are being considered.

The World Holstein-Friesian Federation (WHFF) became active in 1988 and is, today, vigorously pursuing a policy to harmonize type evaluation worldwide. There are 16 approved standard traits, but only the three traits shown in bold in the list below relate to 'feet and legs'. The basic description for each trait must be used although each country may add supplementary information or traits.

- |                               |                           |
|-------------------------------|---------------------------|
| 1. Stature                    | <b>9. Foot Angle</b>      |
| 2. Chest Width                | 10. Fore Udder Attachment |
| 3. Body Depth                 | 11. Front Teat Placement  |
| 4. Angularity                 | 12. Teat Length           |
| 5. Rump Angle                 | 13. Udder Depth           |
| 6. Rump Width                 | 14. Rear Udder Height     |
| 7. <b>Rear Legs Rear View</b> | 15. Central Ligament      |
| 8. <b>Rear Leg Set</b>        | 16. Rear Teat Position    |

Each country may weight traits according to their specific economic environment. For example, in Europe attention is paid to muscularity and size which is appropriate for the meat market in the region. 'Composites' of different type traits (sub-indexes) are permitted.

There is little doubt that implementing type evaluation has had a positive effect on the functional efficiency of black and white dairy cows. However, in some cases the rationale for using the trait remains obscure.

The conformation of a dairy cow does not change after it reaches maturity – the age at which maturity is reached is variable. The physis is the focus of growth for long bones. The age at which growth ceases (closure) is the best indication available from which the age of maturity may be derived (Table 12-1). The final stature of a dairy cow is reached at the age of 48–60 months.

The WHFF recommends that the first evaluation shall take place at 24 months of age when few, if any, acquired changes should have taken place. Evaluation taking place at 24 months is an extremely important criterion although some bias might be introduced depending on the age at which the animal calves.

The issue of acquired traits must be considered very carefully. For example, changes in the shape and size of the claws will occur in animals that have laminitis. First-lactation heifers can suffer from this condition. The claw horn of an animal with laminitis is softer than normal and wears more rapidly. In reality, selecting for feet could be selecting for susceptibility to laminitis rather than for conformation. This issue is complicated by variables such as the degree to which the claw is exposed to moisture, the roughness of the surface on which the animal walks, and whether or not routine claw trimming is practiced.

If a second evaluation is desired at a later date, this should only apply to linear traits that are not subject to change. In practice, first evaluation may be carried out in some countries at 30–32 months. In this case, it would not be possible to make a direct comparison to feet evaluated at 24 months.

There is considerable pressure within the industry to encourage producers to aim for early breeding (see p. 135). However, considerable changes in appearance, body and claw size take place as a heifer gets older. The development of acquired traits can start as soon as a heifer calves for the first time. These changes are particularly marked in intensively fed, high-production heifers managed in loose housing systems. This is discussed at length in other parts of this book. In some countries, allowances are made for age and system of management.

**Table 12-1**

**FORELIMB AND HINDLIMB CLOSURE TIMES**  
(adapted from *Lameness in Cattle*, 3rd edition)

Bone	Physis	Closure Time
<b>Forelimb</b>		
Metacarpus	Distal	2.0–2.5 years
Radius	Distal Proximal	3.5–4.0 years 12–15 months
Ulna	Distal Proximal	3.5–4.0 years 3.5–4.0 years
<b>Hindlimb</b>		
Metatarsus	Distal	2.0–2.5 years
Tibia	Distal Proximal	2.0–2.5 years 3.5–4.0 years
Femur	Distal Proximal	3.5–4.0 years 3.5–4.0 years

## Feet and Legs

### KEY CONCEPTS

- Well over 90% of lesions causing lameness are found in lateral hind claws.
- A biomechanical relationship exists between body weight, the angulation of the limb joints, the size and quality of the claw, the extent to which the claw is vulnerable to disease, and the environment in which the animal is maintained.

From a veterinary perspective, type evaluation of the general characteristic or sub-index ‘feet and legs’ is the most important. Statistical analysis of huge databases has established that feet and legs have a low heritability. The validity of this finding should at least be questioned. The WHFF has had the foresight to describe feet and legs as three separate traits: foot angle, rear legs rear view, and rear legs set. The practice of making a composite or sub-index of these three traits is extremely limiting. If one trait had high heritability and another low, the sub-index would be biased. This probably occurs as the inclination of the canon (metatarsus) is heritable as is the claw diagonal. Neither of these are standard traits.

Research has failed to supply basic data on which to establish a realistic evaluation of feet and legs. For example, it is not known if large feet are more prone to lameness producing lesions than small feet or if the converse is true. Also, no information is available on the parameters of the normal size, shape, and/or volume of feet and how these factors vary with age. A scale for the ratio of weight to cm<sup>3</sup> has never been developed. Despite these reservations, research studies have been published stating that there is a correlation between poor scores for feet and legs and lameness.

## Foot Angle

Sixty percent of the body weight of cattle is borne by the forelimbs. There is also a 60:40 ratio between the volumes of fore and hind claws. Therefore, it is logical that claw volume must be related to its ability to sustain weight and could be expressed as kg/cm<sup>3</sup>. At 24 months of age, each pair of claws of the hind feet should be equal in volume and the dorsal wall (apex to hairline) should not measure greater than 7.5cm. The angle of the fore claw should be about 50° and that of the hind claw slightly less

(Fig. 12-1). Concavity of the dorsal wall of a claw or the presence of a hardship groove (see p. 234) should disqualify an animal as they are powerful indicators that a metabolic 'insult' has taken place. Disproportionate concavity of the axial surface of the lateral hind claw and the axial surface of the medial fore claw should be penalized and should disqualify bulls from breeding if observed at any age. This characteristic has been observed in relatives of animals with corkscrew claw (see p. 237).

A cow exposed to soft surfaces (grass, straw yards, soft pack) will bear weight on the rim of the wall of the claw and perhaps 1.0cm of the adjacent sole. The sole is concave and normally bears very little weight. All this changes when a cow is required to walk on concrete. The wall is worn down and a disproportionate amount of the sole bears weight. In the majority of circumstances, the newly calved heifer will suddenly encounter concrete surfaces for the first time around the time she calves. When this happens, the sole of the claw will start to become flatter due to wear and subjected to trauma. Hemorrhages in the sole start to appear for the first time (see p. 41). As the cow continues to age, her large udder will displace the closeness of the limbs and the surface area of the sole of lateral claw will increase in width. The degree to which this will occur depends on the regularity of claw trimming, the moisture content of the horn (exposure to slurry makes the claw softer), and the presence of laminitis which also softens the claw horn and increases wear. As the lateral claw widens, it will also increase in length and automatically the 'foot angle' will decrease in size (Fig. 12-2).

It is recommended by WHFF that the foot angle should have an intermediate score and this is highly compatible with good foot health. A higher or lower score at 24 months would indicate a serious unsoundness if present in one animal. High or low scores in several of a group of heifers would indicate that management factors might be bringing about acquired changes in the shape of the claw.

Foot angle is not the best (but easiest to measure) indication of claw soundness, but it is adequate until better criteria are developed. Until much more is known about the heritability of claw horn quality, claw volume, rate of increase in claw volume and shape, little progress

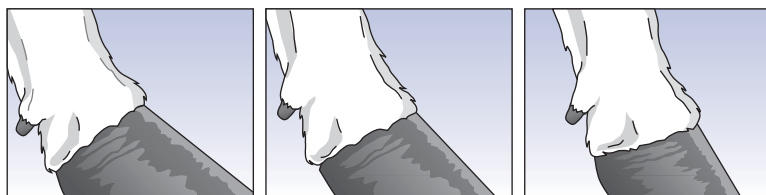
will be made. Foot angle would provide misleading information if applied to animals more than 32 months of age. Subclinical laminitis, when present, causes the greatest change in claw shape (Figs 12-3, 12-4). However, it has never been demonstrated that every cow in a high-production herd has this disorder and/or what characteristics differentiate the affected from the healthy animals. It has been suggested, for example, that the rate of development of rumen papillae may be controlled genetically.

Advances in modern technology make it possible to develop simple photogrammetric imaging techniques that would enhance the accuracy of claw evaluation considerably. Claw volume can be calculated with an accuracy of 88% from three simple measurements. This method only has research application and would not be practical to use on standing cattle.

## Heel Depth

Heel depth is not one of the 16 international standard traits, but it has received some attention in the literature and is a factor taken into consideration by some national Holstein associations. The traditional points for measuring the heel depth have been from the ground perpendicularly upwards to the hairline at the back of the heel. It has proved not only very difficult to take this measurement but also that the repeatability is poor. Dutch workers introduced the heel diagonal, which is much easier to apply. This measurement is highly repeatable, heritable, and includes both claw angle and length of the claws (Fig. 12-5).

The desired heel depth is considered to be 3.8cm and is important because this depth has been correlated to high milk production in first lactation. Heel depth decreases with age (see p. 20), due to wear and perhaps laminitis. The contents of the heel bulb are important shock absorbers, referred to in this text as the Pedal Bone Support System (PBSS). It has been found that there is a significant difference in the composition of the digital cushion between heifers and mature cows. Failure of the PBSS is likely to be implicated in the etiology of white line disease (see p. 93).



**Figure 12-1 Foot Angle WHFF:** The angle at the front of the right hind claw measured from the floor to the hairline. Reference scale: 1 = 15° (very low), 5 = 45° (intermediate), 9 = 65° (very steep).





Figure 12-2 After a heifer is exposed to concrete for the first time, 'slippage' causes the sole of the lateral claw to widen and the foot angle to decrease.



Figure 12-4 This is the same claw as in Figure 12-3 photographed in April 1997. This demonstrates how acquired changes can alter the appearance of a claw without significantly altering the foot angle. A number of other cows in the same group of animals were similarly affected, but others were not. This suggests that some cows are more resistant to metabolic insult than others.



Figure 12-3 This is a relatively normal right hind lateral claw photographed in October 1996.

## Rear Legs Set

### KEY CONCEPT

- If the conformation of the hind limb is completely normal, the point of the hock (tuber calcanei) will lie directly beneath the pin bone (ischial tuber) when viewed from either the side or the rear.

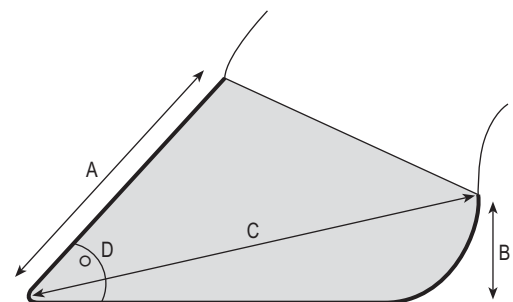


Figure 12-5 Dorsal surface of the claw measured at the dorsal commissure of the wall. This measurement should not exceed 7.5cm in a Holstein heifer aged 24 months. D = foot angle; C = claw diagonal; B = heel height. (Courtesy of W B Saunders, Lameness in Cattle, 3rd edn)

This is an extremely important trait and one that is very easily misinterpreted when changes in posture are present. There is an anatomical device in the limb that reciprocates changes in the angle of the hock with those of the stifle. Therefore, assessing the angle of the hock indirectly

assesses the angle of the stifle. The smaller the angles of the hip, stifle, and hock, the more the weight of the animal is supported by muscles. The system of joint angulation and muscle flexion works as an articulated shock absorber (Fig. 12-6). However, the straighter the limb, the more impact there will be on the delicate cartilaginous surfaces of the joints. It is thought that arthritis is more common in post-legged cattle. Serous tarsitis (puffy hock, bog spavin) is more prevalent in animals with straight hind legs.

Correct positioning of the point of the hock beneath the pin is essential when evaluating the angles of the joints. Pain in the toe will cause the animal to draw the leg forward giving an appearance identical to sickle hock. Conversely, conditions such as sole ulcer and heel erosion will draw the limb further back than normal which gives the appearance of a straight leg (for further information of changes in posture see pp. 31 and 32).

In one study, it was found that the mean angle of the hock was  $167.3^\circ \pm 0.7$  (range  $154.3\text{--}177.4^\circ$ ) and that there is a decrease in the angle with age. Heifers housed indoors appeared to retain their straight-angled hocks.

The WHFF has correctly assessed a hock angle of  $160^\circ$  as being straight. The WHFF does not go so far as to state that angles greater than this (say  $165^\circ$ ) should be considered a sub-lethal trait and classify the as animal unsound for breeding, but this is probably the case.

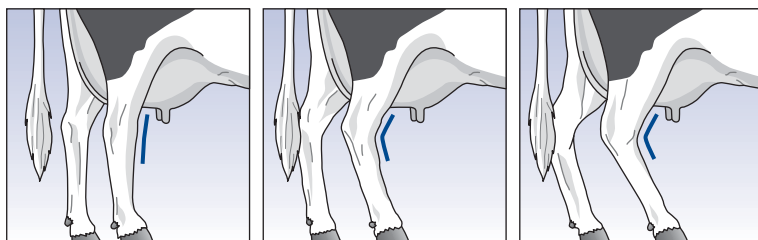
An equally important trait considered by some national Holstein associations is the slope of the pastern. This is another component of the shock absorbing system. If the slope is extremely steep, it cannot contribute enough to

shock absorption. If the slope is too flat, there will be increased probability of damage occurring to the tendons and ligaments of the foot. The ideal slope of the pastern is not yet known.

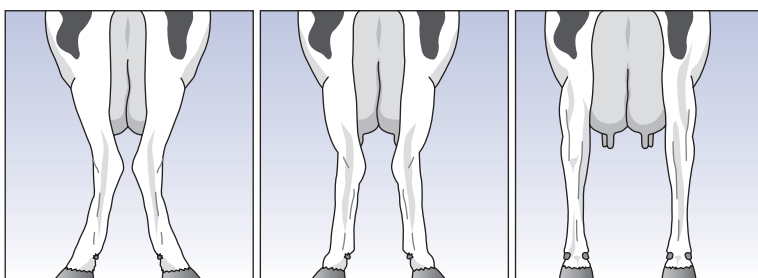
Rear leg set must be considered in conjunction with stature.

### Rear Legs Rear View

When viewed from behind, the cannon (metatarsus) should be vertical to the ground and the hock and feet should lie parallel to the midline of the body (Fig. 12-7). Any degree of rotation inwards of the point of the hock and outward turning of the claws in an animal 24 months of age should be considered a major unsoundness. As an animal confined on concrete gets older, the lateral hind claw will widen. In many instances, there may be a build-up of horn beneath the heel. This is referred to as 'overburdening.' Invariably, the hock of a cow with an overburdened lateral hind claw will turn inwards and the posture will be referred to as 'cow hocked.' Expert claw trimming can return the claw to normal shape and many times the posture of the hock will correct itself within weeks after trimming. Although this is a correctable acquired trait, it does not occur in all cows of the same age and maintained under the same conditions. It is, therefore, probable that a weakness in conformation exists if cow hock is noted in animals before they are 48 months of age.



**Figure 12-6 WHFF definition.** Rear leg set is the angle measured at the front of the hocks. 1–3 Straight ( $160^\circ$ ); 4–6 Intermediate ( $147^\circ$ ); 7–9 Sickle ( $134^\circ$ ).



**Figure 12-7 WHFF definition.** Rear legs rear view is the direction of the feet when viewed from the rear. 1 = Extreme toe-out; 5 = Slight toe-out; 9 = Parallel feet.

## Frame and Capacity

### GLOSSARY

**Frame:** This is interpreted as the physical size of the skeleton and is usually expressed in general terms as large, medium, or small.

**Capacity:** Describes the space occupied by the organs of the body which are confined in the fixed structure of the chest and within the expandable wall of the abdomen.

**Stature:** This is measured from the ground to the sacrosiatic junction which is located in the center line of the body between the hooks (tuber coxae).

### KEY CONCEPTS

- Frame and capacity are a combination of traits that are believed to be a fair representation of an animal's ability to survive provided that the feet and legs remain sound.
- The WHFF defines the location for measuring stature as lying between the hips. Traditionally, the hook or tuber coxae has been referred to as the hip. The hip joint lies somewhere between the hook and the pin and is referred to as the thurl. In order to avoid confusion it would be preferable to use the term loin height.

## Stature

The reference scale of stature, as defined by the WHFF (Fig. 12-8), is 130–154cm (52–62ins) in a heifer 24 months of age. The point scale is calculated in increments of 3cm per point from 1 to 9. Most countries will make the optimal score at 7 or even less. It is generally thought that very tall animals consume more feed than is cost effective. On the other hand, stature is considered to be related to udder depth.

Stature is driven to some extent by puberty (see Table 12-1). That is to say, measures taken to advance puberty may also accelerate physis closure and reduce an animal's final height. Bonsma convincingly demonstrated with live cattle that an animal's stature was correlated to sexuality. He cited examples of tall animals having low fertility.

Neither of these observations have been confirmed by scientific research.

Stature is also manipulated by the rear legs set. The straighter the rear legs, the taller the animal is likely to be at the rear.

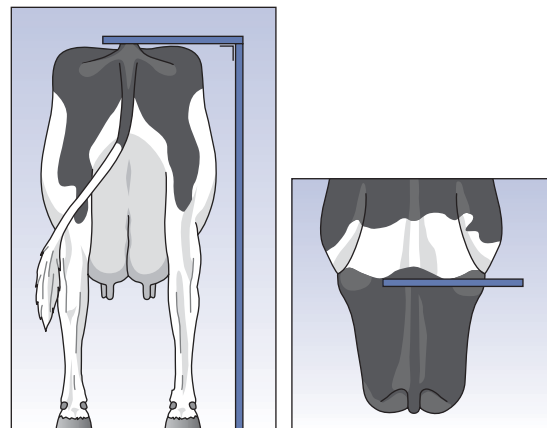
The height at the withers (height at front end) is no longer a standard trait. The desired height in line with breeding-practice recommendations is 139cm (55.6ins) at 24 months (see Table 11-1). The withers height and body weight are used as criteria for breeding and this may affect stature at 24 months. The withers height of a mature cow is considered to be over 142cm (56ins).

## Chest Width

Chest width is another standard linear trait that can also be measured objectively. The measurement is taken between the inside surfaces at the highest point between the front legs, which could be described as the crease that forms the armpit of a cow.

The reference scale recommended by WHFF (Fig. 12-9) ranges from 13cm to 29cm calculated in increments of 2cm per point.

Chest width is an important factor in calculating the capacity of a cow. The chest width partly replaces the older estimation of 'heart girth.' Heart girth is the measurement taken by a tape placed around the chest immediately behind the elbow. Heart girth has been used to calculate the weight of an animal with reasonable accuracy. Stature and weight can be used as an estimation of the size of an animal.



**Figure 12-8 WHFF definition.** Stature is measured from the ground to the spine between the hooks (tuber coxae). This is a precise measurement in centimeters or inches. 1 = Short (130cm or 52ins); 5 = Intermediate (142cm or 57ins); 9 = Tall (154cm or 62ins).

There is a correlation between the width of the animal and the distance between the two hook bones (tuber coxae). This measurement is rarely used, but when it is, is considered to be an indicator of an animal's constitution.

## Body Depth

This is the vertical distance from the spine (chine) to the lowest dependent point of the abdomen. The WHFF specifies (Fig. 12-10) the level of the last rib which may be a difficult landmark to use in a cow with a large udder.

This is a purely subjective evaluation but is of no less value for being so. However, the observer must be very aware that this trait will vary according to the degree of fill (time of last meal). The trait will also be affected by the stage of pregnancy. It might be more accurate to define the depth measured vertically from the most posterior part of the sternum (xiphoid cartilage.) Caudal to xiphoid the contour of the belly would be affected by the weight of abdominal contents.

## Angularity

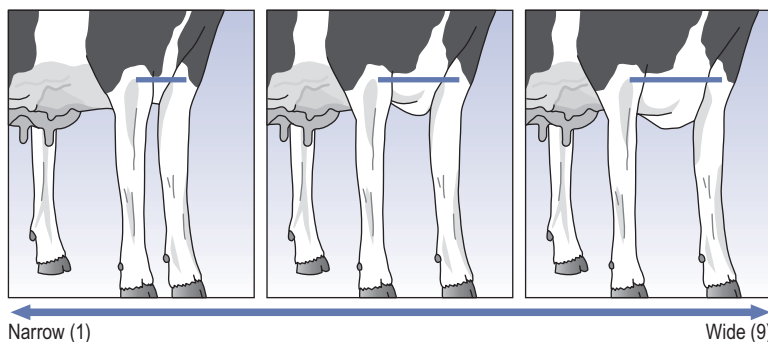
Angularity is defined by WHFF (Fig. 12-11) as the angle and openness of the ribs, combined with flatness of bone

avoiding coarseness. WHFF admits that angularity has been particularly questioned as to its relevance within the program. Also, WHFF acknowledges angularity to be a descriptive trait. It is claimed to be assessed with a high degree of confidence and accuracy, producing a heritability figure equivalent to that for production traits – around 0.33. The trait angularity tends to reinforce or replicate (depending on one's perspective) the trait body depth.

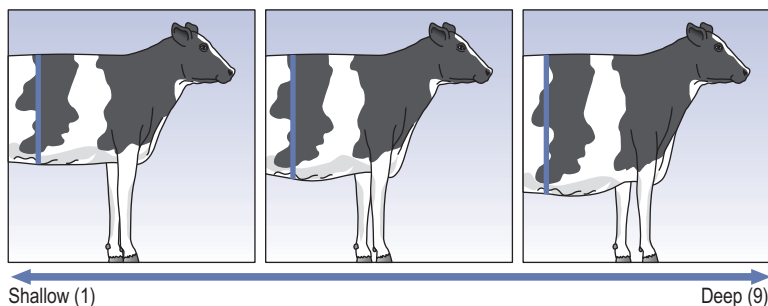
The degree of fat deposition has no place in assessing angularity.

WHFF is seriously considering including the body condition score (BCS) as a standard trait. Undeniably, this would be a very important trait if it could be evaluated strictly to age or to some specific timeframe during first lactation. However, the BCS varies throughout lactation and may be related more to production traits than to an animal's functional efficiency. Monitoring BCS is an extremely important part of managing nutrition (see pp. 65 and 137).

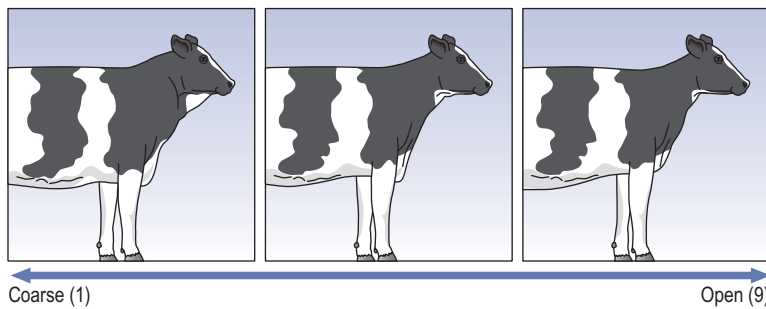
A portion of the score for angularity is assigned to the flatness or coarseness of bone. The rationale for this requirement may be more esthetic than scientific. Some national Holstein associations take into consideration bones other than the ribs. Until it is known if the amount of hematopoietic marrow varies with the coarseness or flatness of bones, it might be wise not to lay too much weight on this part of the trait of angularity.



**Figure 12-9 WHFF definition.** Chest width measured from the inside surface between the top of the front legs. 1–3 Narrow (13cm); 4–6 Intermediate; 7–9 Wide (29cm). Width increases at the rate of approximately 2cm per point.



**Figure 12-10 WHFF definition.** Body depth is the distance between the top of the spine and bottom of the barrel at the last rib – the deepest point. This is evaluated independently from stature. 1–3 (shallow); 4–6 (intermediate); 7–9 (deep).



**Figure 12-11 WHFF definition.**  
 The angularity of an animal is the angle and openness of the ribs, combined with the flatness of bone avoiding coarseness. 1–3 (Lacks angularity, close ribs coarse bone); 4–6 (Intermediate angle with open rib and intermediate bone quality); 7–9 (Very angular open ribbed flat bone). Reference scale: weighting of three components; angle and open rib 80%, bone quality 20%.

**Table 12-2**

REGIONAL DIFFERENCES IN LONGEVITY IN THE UNITED STATES (Caraviello et al 2004)			
Region of the United States	Number of Cows	Number of Herds	Failure Time Days After First Calving
North East	382,444	2,684	722
South East	144,786	717	684
Central	289,807	2,152	679
East North Central	379,470	2,874	657
West North Central	101,593	660	649
South	217,234	1,210	666
South West	177,832	391	693
North West	280,283	798	696
West	348,940	445	700

## Longevity

### KEY CONCEPT

- Longevity is defined as the number of days from first calving until culling.

The inadequate longevity of Holstein dairy cows is clearly of great concern to the dairy industry in many countries. Selection for functional traits such as udder health and fertility has a positive effect on longevity. A strong correlation has also been found between longevity and feet and legs.

Environmental conditions and management practices may differ widely between geographical regions.

Factors such as herd size, housing facilities, feeding programs, and heat stress can affect the voluntary and involuntary culling policies of individual herds. Therefore, as would be expected, many factors have to be considered when calculating longevity (Table 12-2).

Drackley (2005) pointed out that:

*‘... interest has increased recently in the question of whether early life events, particularly plane of nutrition and subsequent rates of growth during the milk feeding period, might affect later life health, productivity, and longevity... in many ways this is a unique question, one that probably would not have been asked a decade ago or, if it were asked, one that would be roundly dismissed.’*

This is an interesting comment in view of the fact that it is not yet known if there is a correlation between early calving (and the management of the young animal to achieve that end) with longevity.

The risk of culling Holstein cows relative to lactation average somatic cell count (SCC) has been examined.

A survey in Europe showed that foot and leg problems accounted for > 50% of all culled cows. The authors suggest that foot and leg measurements and walking ability should be included among criteria for selective replacement stock.

### Heritability (see Table 12-3)

As the result of many years of study, German geneticist Ottmar Distl is confident that strategies for improving leg and claw quality are being developed. He states:

*‘Important parameters for claw and leg quality can only be identified when traits used in breeding work are closely related to claw health, longevity, life time performance and functional efficiency of the animal. This definition implies that claw and leg quality cannot be recorded by just one trait. The traits necessary seem to be more complex and may be of different importance in dependence of the exposure to environmental effects. Particularly, claw shape is a result of the interaction between individual factors and environment. Genetic components may respond differently to specific environments and in each specific environment other genetic components may play the prominent role.’*

Distl (2003) also points out:

*‘Using measurable claw traits in the selection of young bulls before licensing, functional longevity and foot quality of cows in dairy farms can be significantly improved.’*

It has been demonstrated that the daughters of some bulls were more likely to suffer from lameness of digital origin than those of other sires.

The most common claw traits were discussed by the European Association for Animal Production Working Group ‘Claw Quality in Cattle.’ These traits consisted of an evaluation of the claw shape, the quality of claw horn, and features of the inner structure of the claw. Several studies demonstrated that these traits had sufficiently high additive genetic variation to achieve genetic improvement.

German workers assert that the inclusion of claw measurements in breeding programs would lead to a reduction in claw defects/diseases and, subsequently, in culling rates.

Bulls are not subjected to the same stresses as are cows and, consequently, show fewer acquired abnormalities or lesions. It is, therefore, advisable to apply stricter criteria when evaluating the claws of bulls than those of cows:

- heritability of hoof measurements are between 0.2 and 0.5
- sole hemorrhages 0.1–0.2
- angle of the toe and toe length 0.1
- heel height of the lateral hind claw 0.4.

**Table 12-3**

HERITABILITY (on diagonal), GENETIC (below diagonal) AND PHENOTYPIC (above diagonal) CORRELATIONS FOR THE BLACK-AND-WHITE STANDARD (between brackets are the standard errors)

	RLS Rear View	RLS Side View	Foot Angle	Locomotion	Feet & Legs
Rear Leg Set Rear View	<b>0.16</b> (.01)	-0.22 (.00)	0.35 (.00)	0.55 (.00)	0.59 (.00)
Rear Leg Set Side View	-0.35 (.04)	<b>0.26</b> (.01)	-0.49 (.00)	-0.24 (.00)	-0.31 (.00)
Foot Angle	0.44 (.03)	-0.74 (.02)	<b>0.18</b> (.01)	0.35 (.00)	0.44 (.00)
Locomotion	0.80 (.02)	-0.40 (.04)	0.47 (.03)	<b>0.13</b> (.01)	0.21 (.00)
Feet & Legs	0.80 (.02)	-0.52 (.04)	0.60 (.03)	0.95 (.01)	<b>0.17</b> (.01)

The first three traits are official linear traits as defined by WHFF, ‘feet and legs’ is a descriptive trait, used in the Netherlands to score the overall quality of the feet and legs. (Report on analysis of locomotion in the Netherlands Ref. R&D/04.0146/Gdj)

## Posture (also see Chapter 3)

### KEY CONCEPTS

- Postural changes are caused by an animal seeking to gain comfort by altering the position of its limbs.
- Variations in posture contribute to the difficulty of making accurate evaluations of conformation.

Scores or even actual measurements of individual cows often show large changes when they are observed after the cow moves a few steps. Postural problems significantly distort evaluation of rear legs rear view and rear legs set.

Differentiating between abnormal posture and abnormal conformation requires training, considerable knowledge, and years of experience. Using amateur evaluators to judge the conformation of young beef bulls is a very dangerous practice (Fig. 12-12).

## Descriptive Traits

Descriptive traits are usually based on esthetic appreciation rather than on scientific justification. For example, a cow with a 'wry face' might be given some penalty. This is comparable to admitting only the most handsome and beautiful students to a veterinary school. Such a selection might compromise academic prowess but, of course, it could enhance acceptability of the graduates to potential clients.

Some descriptive traits, such as those relating to the pastern, could have value – in which case a scientific basis for inclusion as a linear trait should be considered. Many other descriptive traits are a distraction and counterproductive to the objectives of trait evaluation. Without question, an official evaluator must have flexibility and latitude in making a final assessment. This is completely possible if the evaluator is knowledgeable about the impact of high-production technology on the health of a dairy cow as well as having experience in assessing strength and vigor. There is no place for a checklist of arcane terms of dubious significance.



**Figure 12-12** Bow leg can be confused with the clinical signs of laminitis affecting only the medial claws of the hind feet. Animals walking with their feet close together are said to be 'walking narrow.'

## Locomotion

The WHFF is considering adding locomotion to the list of standard linear traits. (See Fig. 12-13 and Table 12-4.) The trait is simply described as the ease of use of feet and legs. It is perhaps being interpreted as a measure of lameness and/or the degree of ab-/adduction present. Locomotion has a heritability of 0.13, which is reasonable for a feet and leg trait and in line with what was found in the UK. Locomotion has a high genetic correlation with feet and legs and has an expected high genetic correlation with rear leg set rear view. This trait has either been adopted by, or is in the process of being adopted by, the United Kingdom, France, the Netherlands, Italy, United States, Spain, and Germany.

**Table 12-4**

**FOR LOCOMOTION** (based on description as used by Holstein-Friesian Society of Great Britain)

Locomotion Score	Description
1	lame
2	severe ab-/adduction present, uneven gait, short strides
3	ab-/adduction present, uneven gait
4	slight ab-/adduction present, even gait, short strides
5	no ab-/adduction present, even gait, short strides
6	slight ab-/adduction present, even gait, medium strides
7	slight ab-/adduction present, even gait, long strides
8	no ab-/adduction present, even gait, medium strides
9	no ab-/adduction present, even gait, long strides

Adding locomotion to the list of standard traits cannot be condemned from the perspective of foot health. Irrespective of the causal lesion, it can be argued that a heifer should not be lame or have aberrations of gait at 24 months of age. Chance intervention of accidental risk factors, such as an encounter with a foreign body or infectious agent, will occur.



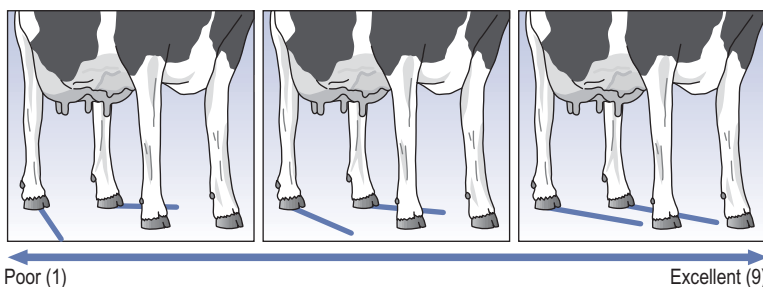
**Figure 12-14** Esthetically this was the ideal bull of the 18th century. Modern tastes are different. Today, a pleasing characteristic with no objective means of measurement and having no scientific or logical justification is referred to as a descriptive trait. Soundly based and thoroughly tested linear traits should not be confused with show-ring evaluation. (Courtesy of Anon)

### The Conformation of Beef Breeds

The selection of beef cattle for breeding purposes does not parallel the sophisticated system employed by the dairy industry. The criteria tend to vary between breeds. The influence of the show ring is often much greater (Fig. 12-14).

In beef cattle, stature is also measured at the loin. Sometimes hip height is used (the height from the ground to the hook [tuber coxae]). The tuber coxae tends to vary in position relative to the level of the loin (sacrosciatic junction).

The conformation of beef breeds is dictated largely by the consumer. In days gone by, housewives looked for large steaks which came from a large carcass. Breeders of beef cattle responded by selecting breeding stock with greater stature, giving preference to cattle with straight



**Figure 12-13** WHFF definition of locomotion. Locomotion is the use of legs and feet, length and direction of the step. 1-3 severe abduction and short stride; 4-6 slight abduction and medium stride; 7-9 no abduction and long stride.



hindlimbs. This policy was based on a completely false concept. The cutting ratio of bone to meat remains the same irrespective of joint angle. Cattle with straight legs (post legged) have an increased predisposition to arthritis (gontitis, coxitis, and tarsitis).

Young bulls are selected on three main criteria: average daily weight gain, thickness of the back fat, and testicular circumference. The feed regimen required to obtain maximum daily weight gain causes permanent damage to the feet of some, possibly all, young bulls. In countries where this manner of raising bulls is practiced, the longevity of male breeding stock is poor.

## BIBLIOGRAPHY

- Ahlstrom G, Gunilla R, Berglund B et al 1986 Hoof and leg traits of Swedish dairy cattle. *Journal of Veterinary Medicine* 33:561–587
- Andersson L, Lundström K 1981 The influence of breed, age, bodyweight and season on digital disease and hoof size in dairy cows. *Zentralblatt Veterinar Medizin* 28:141–151
- Baumgartner C, Distl O 1990 Genetic and phenotypic relationships of claw disorders and claw measurements in first lactating German Simmental cows with stayability, milk production and fertility traits. *Proceedings of the 6th International Symposium on Disorders of the Ruminant Digit*, Liverpool, p 199
- Baumgartner C, Distl O, Krausslich H 1990 Suitability of indicator traits in breeding for claw health in German Simmentals. 2. Relationships between claw parameters and model calculations for genetic gain. *Zuchtungskunde* 62:208–221
- Bonsma J C 1973 In: Cunha T J, Warwick A C, Kroget A C (eds) *Factors affecting the calf crop*. University of Florida Press, Miami, p 197–231
- Berg J N, Butterfield R M 1973 *New concepts of cattle growth*. John Wiley, New York
- Cassel B G, White J M, Vinson W E et al 1973 Genetic and phenotypic relationships among type traits in Holstein-Friesian cattle. *Journal of Dairy Science* 58:1171–1177
- Caraviello D Z, Weigel K A, Gianola D 2004 Analysis of the relationship between type traits and functional survival in US Holstein cattle using a Weibull proportional hazards model. *Journal of Dairy Science* 87(8):2677–2686
- Caraviello D Z, Weigel K A, Shook G E, Ruegg P L 2005 Assessment of the impact of somatic cell count on functional longevity in Holstein and Jersey cattle using survival analysis methodology. *Journal of Dairy Science* 88:804–811
- Christensen L G, Einarsson S, Rendel J 1998 Possibilities for general improvement of disease resistance, functional traits and animal welfare. *Acta Agriculturae Scandinavica. Section A Animal Science Supplement* 28:77–89
- Clark C R, Petrie L, Waldner C et al 2004 Characteristics of the bovine claw associated with the presence of vertical fissures (sandcracks). *Canadian Veterinary Journal* 45:585–593
- Diers H, Swalve H 1987 Estimation of genetic parameters and breeding values for linear scored type traits. *Proceedings of the 38th Annual Meeting of the European Association for Animal Production*, Lisbon
- Distl O, Huber M, Graf F et al 1984 Claw measurements of young bulls at performance testing stations in Bavaria. *Livestock Production Science* 11:587–599
- Distl O 1994 Genetic improvement of claw and leg traits. *Proceedings XIIIth International Symposium on Disorders of the Ruminant Digit*, Banff, p 124–135
- Distl O 1995 Genetic improvement of traits of feet and legs as well as claw soundness in cattle. *Zuchtungskunde* 67:438–448
- Distl O 1996 Selection on the basis of body conformation traits. *KB Mitteilungen* 34:23–25
- Distl O 1998 Selection for limb traits in cattle. *Milchpraxis* 36:92–95
- Distl O 1999 Breeding for soundness of feet and legs in dairy cattle. *Zuchtungskunde* 71:446–458
- Distl O 2003 Implications of health traits in breeding of livestock. *Zuchtungskunde* 75(5): 390–400
- Distl O, Koorn D S, McDaniel, B T et al 1990 Claw traits in cattle breeding programs: Report of the European Association of Animal Production working group 'Claw Quality in Cattle.' *Livestock Production Science* 25:1–13
- Dillon P, Veerkamp R F 2002 The business and technology of dairying. *Proceedings Teagasc National Dairy Conference*, Killarney, p 45–58
- Dorp T E van, Dekkers J C M, Martin S W, Noordhuizen J P T M 1998 Genetic parameters of health disorders, and relationships with 305 day milk yield and conformation traits of registered Holstein cows. *Journal of Dairy Science* 81(8):2264–2270
- Dorp T E van, Boettcher P, Schaeffer L R 2004 Genetics of locomotion. *Livestock Production Science* 90(2/3):247–253
- Drackley J K 2005 Calf and heifer rearing: principles of rearing the modern dairy heifer from calf to calving. *Proceedings 60th University of Nottingham Easter School in Agricultural Science*, Nottingham, UK, p 213–235
- Gilmore J A 1978 The effect of housing, age, breed and time after trimming on hoof measurements. *Journal of Dairy Science* 60(Supplement 1):146
- Greenough P R 1980 A review: The conformation of cattle. *Bovine Practice* 1:20–34
- Greenough P R 1987 A method for measuring conformation of cattle from a 35mm transparency and a digitizing pad and computer. *Proceedings of 23rd World Veterinary Congress*, Montreal, 10.6.18
- Greenough P R 1988 Objective studies in bovine conformation. *15th World Buiatrics Congress*, Palma de Mallorca, p 339–344
- Groen A F, Hellinga I, Oldenbrok J K 1994 Genetic correlations of clinical mastitis and feet and legs problems with milk yield type traits in Dutch Black and White dairy cattle. *Netherlands Journal of Agricultural Science* 42:371–378

- Habel R E 1948 On the inheritance of metatarsal inclination in Ayrshire cattle. *American Journal of Veterinary Research* 3:131–139
- Hand R K, Gould S R, Basarab J A et al 1986 Condition score body weight and hip height as predictors of gain various breed crosses of yearling steers on pasture. *Canadian Journal of Animal Science* 63:447–452
- Hahn M V 1979 Studies of genetic and environmental characteristics of hooves of dairy cows. PhD Thesis, North Carolina State University, Raleigh
- Hahn M V, McDaniel B T, Wilk J C 1977a Variation in and relationships among various hooves in two breeds of dairy cattle. *Journal of Dairy Science* 60[Suppl 1]:146–147(Abstr)
- Hahn M V, McDaniel B T, Wilk J C 1977b Repeatability of measurements of variation in feet of dairy cattle. *Journal of Dairy Science* 60[Suppl 1]:146(Abstr)
- Hahn M V, McDaniel B T, Wilk J C 1987b Heritabilities of objectively measured hoof traits of Holsteins. *Journal of Dairy Science* 61[Suppl 1]:83–84(Abstr)
- Hahn M V, McDaniel B T, Wilk J C 1984a Description and evaluation of objective hoof measurements of dairy cattle. *Journal of Dairy Science* 67:229–236
- Hahn M V, McDaniel B T, Wilk J C 1984b Genetic and environmental variation of hoof characteristics of Holstein cattle. *Journal of Dairy Science* 67:2986–2998
- Howlett CR, 1972 Inherited degenerative arthropathy of the hip of young beef bulls. *Australian Veterinary Journal* 48:562
- Huber M, Distl O, Graf F 1983 Claw measurements of young bulls at performance testing stations in Bavaria. 34th Annual Meeting Study Committee, European Association of Animal Production, Madrid
- Krastev M, Gaidarska V, Toteva M 2002 Effect of some factors on the length of production life of Black and White cows. II. Age and live weight at first conception and calving. *Zhivotnov' dni Nauki* 39(6):7–8
- Meyer K, Burnside EB, Hammond K et al 1985 Evaluating dairy sires for conformation of their daughters: use of first classification records. *Australian Journal of Agricultural Research* 36:509–525
- McDaniel BT, Verbeek B, Wilk J C et al 1984a Relationships between hoof measures, stayabilities, reproduction and changes in milk yield from first to later lactations. *Journal of Dairy Science* 67[Suppl]:198–199(Abstr)
- McDaniel B T, Verbeek B, Hahn M V et al 1984b Genetics of hoof measurements: repeatabilities, heritabilities and correlations with yields by lactation. *Journal of Dairy Science* 67[Suppl]:199(Abstr)
- Orgmets E 2004 Animal breeding in the Baltics. Proceedings of the 10th Baltic Animal Breeding Conference, Tartu, Estonia, p 74–79
- Plate H A M, McDaniel B T 1990 Description and evaluation of measuring rear legs, side and rear view using photogrammetry in Holstein-Friesians. Department of Animal Science, North Carolina State University
- Politiek R D, Distl O, Fjeldaas T et al 1986 Importance of claw quality in cattle: review and recommendations to achieve genetic improvement. Report of the European Association for Animal Production, working group on claw quality in cattle. *Livestock Production Science* 115:133–152
- Reurink A, Van Arendonk J A M 1987 Relationships of claw disorders and claw measurements with efficiency of production in dairy cattle. 38th Annual meeting European Association of Animal Production, Lisbon
- Rogers G W, McDaniel B T, Dentine M R et al 1989 Genetic correlations between survival and linear type traits measured in first lactation. *Journal of Dairy Science* 72:523–527
- Russell A M, Bloor A P, Davies D C 1986 The influence of sire on lameness in cows. Proceedings of the Vth International Symposium on Disorders of Ruminant Digit, Dublin, p 92–99
- Scott T D, Naylor J M, Greenough P R 1999 A simple formula for predicting claw volume in cattle. *Veterinary Journal* 158:190–195
- Sittmann K, Kendrick J W 1964 Hereditary osteoarthritis in dairy cattle. *Genetics* 35:132
- Smit H, Verbeek B, Peterse D J et al 1986a The effect of herd characteristics on claw disorders and claw measurements in Friesians. *Livestock Production Science* 15:1–9
- Smit H, Verbeek B, Peterse D J et al 1986b Genetic aspects of claw disorders, claw measurements and 'type' scores for feet in Friesian cattle. *Livestock Production Science* 15:205–217
- Smith S P, Allaire F R, Taylor W R et al 1985a Genetic parameters and environmental factors associated with type traits scored on an ordered scale during first lactation. *Journal of Dairy Science* 68:2058–2071
- Smith S P, Allaire F R, Taylor W R et al 1985b Genetic parameters associated with type traits scored on an ordered scale during second and fourth lactations. *Journal of Dairy Science* 68:2655–2663
- Swanepoel F J C, Heynes H 1986 The relationship between body measurements and growth test results of Simmentaler bulls. *South African Journal of Animal Science* 16:31–35
- VandeHaar M J 1998 Accelerated heifer growth: Truth or Consequences. Proceedings Tri-State Dairy Nutrition Conference, Fort Wayne
- Van Raden P M, Klaaskate E J H 1993 Genetic evaluation of length of productive life including predicted longevity of live cows. *Journal of Dairy Science* 76:2758–2764
- Vermunt J J, Greenough P R 1996 Hock angles of dairy heifers in two management systems. *British Veterinary Journal* 152:237–242

# The Downer Cow and Peripheral Neuropathies

## THE DOWNER COW SYNDROME (INVOLUNTARY RECUMBENCY)

### GLOSSARY

**Downer cow:** Any cow unable to rise for no obvious reason.

**Creeper:** Downer cows that are alert and able to crawl are referred to as 'creepers' and have a reasonable possibility of spontaneous recovery.

### KEY CONCEPTS

- Do not miss the obvious and remember the four Ms:
  - Milk fever
  - Metritis
  - Mastitis
  - Musculoskeletal dysfunction.
- Skilled nursing and animal care procedures are the secrets of successfully resolving recumbency.
- The highest incidence of recumbency occurs in periparturient dairy cows and is associated with hypocalcemia.

## Introduction

Attempting to find the reason for a cow failing to rise to its feet is one of the most difficult tasks for the practicing veterinarian. Dealing with this problem adequately is a very distinct art. The condition of the animal can change in a matter of hours. Many cases of recumbency start off as a simple milk fever which responds to treatment. However, the cow's first attempts to rise may be unsuccessful. The floor may be slippery or she may be cramped in the corner of a box and have insufficient lunge space. Early failure can lead to a psychological unwillingness to try to get up. As time passes, pressure on blood vessels, caused by the animal lying with one limb under the body, will deprive muscles of oxygen and the cow will lose the strength to lift herself.

The passively recumbent cow has about 6 hours, or 'the golden period,' before irreversible changes in the musculature of the limbs will commence. Dairy farmers are often tempted to 'wait and see,' but such a policy is quite often disastrous. Some active downer cows may rise after more than 14 days of recumbency, but this is the exception.

In dealing with a downer cow, a veterinarian is well advised to develop a protocol that is applied in every case of recumbency irrespective of any other consideration. The following guidelines may assist in developing such a protocol:

- Evaluate the history, appearance, and environment of the recumbent cow.
- If the cow has recently calved, always treat for milk fever. If the animal is unusually bright, take a blood sample and submit for testing for calcium, phosphorous, and magnesium.
- Always make a vaginal check. It is embarrassing to return later to find a decomposing fetus.
- A rectal examination will eliminate fracture of the pelvis.
- On every visit, check each quarter of the udder and draw milk. Toxic mastitis can develop over a short period.
- If the animal is located on a slippery floor and she struggles but fails to rise, move her somewhere with a non-slip base. A cow that has worked herself to face into the corner of a box is likely to lose the will to try to rise. Slide her around to face an open door and tie her calf in sight and sound.
- Always impress on the farmer that the cow must be turned from one side to the other every 2 hours at least. This becomes imperative if the animal is making minimal efforts to rise.

## Evaluating the Recumbent Cow

### History

Has she recently calved? It is very rare indeed that a heifer will suffer from hypocalcemia. If the animal has not calved within the past 4 weeks, it is likely that some form of trauma is involved.

### Appearance of the Patient and the Environment

The animal may be in lateral recumbency. This is an emergency situation. If this is the case, she will be in urgent danger of regurgitating rumen fluid and aspirating it into the lung. She is likely to be bloated (tympanic) and this will cause undue pressure on the heart. The animal must be returned to sternal recumbency and rumen pressure relieved before calcium therapy is commenced. In these cases, the calcium should be administered slowly and the heart monitored (auscultated) throughout the treatment for any variation in heart rate. If there is a variation in heart beat, the flow of liquid should be stopped temporarily.

### Is the Animal Dull and Listless and also Dopy?

This type of appearance is suggestive of hypocalcemia. When presented, the animal may have already been treated for hypocalcemia. In this case, the blood electrolyte picture may be misleading, but it is still prudent to take a blood sample.

### Cow May Appear Depressed, Listless, Hang its Head, Droop its Ears and Eyelids

This is the typical appearance of a toxic cow. This picture can be mistaken for hypocalcemia; therefore, a routine evaluation of the animal's vital signs must be made when the case is first presented.

The rectal temperature should be within the normal range. If it is lower than normal, some level of shock might be present.

The persistence of a skin fold for more than 6 seconds would indicate some degree of dehydration. Pallor of the mucous membranes would be suggestive of toxemia, in which case a weak pulse and tachycardia may be present.

The respiration of a recumbent cow may be labored by virtue of the pressure of the abdominal contents of the diaphragm. This quality of respiration should not be confused with a more advanced stage of hypostasis and pulmonary congestion with edema being present. In these cases, pulse and heart rates may be elevated and the nasal mucosa bright red or cyanotic. Early pneumonia or anaphylaxis might be suspected.

The udder should be examined and milk expressed to ascertain if toxic mastitis is present. Next, a vaginal examination should be made. There may be evidence or history of trauma caused by dystocia. A second calf may be present or acute metritis may be diagnosed.

A rectal examination may reveal a pelvic fracture or lumps which may be an organizing blood clot or necrotic fat.

### The Cow May Appear to be Alert

Many downer cows may be 'alert' and referred to as 'a creeper.' Nevertheless, a routine examination would include exploration of the udder and reproductive organs.

### Does the Cow Appear to be Pathetic?

Psychosomatic recumbency may occur if the animal attempts to rise, fails to do so, and gives up trying. This may be the case when the animal is recumbent on slippery floors or is facing into a corner and is deprived of lunge space. Musculoskeletal damage can result from ineffective attempts to rise.

### Is the Recumbent Patient a Young Animal or is the Case Unrelated to Parturition?

This type of recumbency is likely to be either the result of physical injury or from a bizarre cause, either of which requires careful detailed examination. The positioning of the hindlimbs may be an indication of the cause of the recumbency.

Both limbs splayed out sideways. This posture has frequently been described as typical of obturator paralysis (which will be discussed later). This is an unlikely diag-



**Figure 13-1** Cows with hypocalcemia soon go into lateral recumbency if left untreated. If the animal has been thrashing with the hindlimbs, hypomagnesemia or tetanus should be suspected. In either of these disorders, the animal will probably respond to a sudden loud noise by going into a spasm.

nosis as a complication for a downer cow or recumbency unrelated to parturition.

The animal should be rolled into lateral recumbency and each hip deeply palpated while the limb is alternatively flexed, then twisted by an assistant in order to check that the hip has not been dislocated (see p. 281). Palpation of the muscle bundles on the inside of the thigh may reveal some that are harder than others and be suggestive that compartment syndrome exists. Manipulation of the limb will also reveal fracture of a long bone if this is not already obvious. This is also the appropriate time to examine per rectum for crepitation indicative of pelvic fracture. Abnormal swellings inside the pelvis would also be identified at this time.

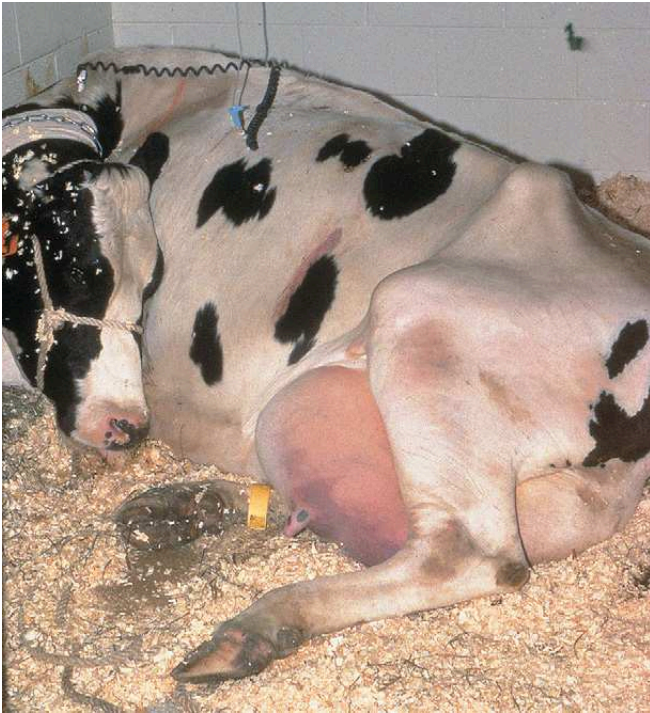
See Figures 13-1–13-9.



**Figure 13-2** The typical hypocalcemic cow may still be in sternal recumbency but the head will be turned into the flank and the eye will have a glazed non-attentive appearance. When the legs slide out to the side, it is reasonably certain the animal will shortly slide into lateral recumbency. (Courtesy of Anon)



**Figure 13-3** A cow in lateral recumbency will still have a dopy appearance if the cause is hypocalcemia.



**Figure 13-4** The appearance of this cow could be confused with that of an animal suffering from milk fever. However, close examination of the udder revealed cyanotic discoloration. Further investigation of the vital signs confirmed that this animal was suffering from toxic shock. (Courtesy of B Welker)



**Figure 13-6** Channel Island breeds seem to be prone to 'give up trying' in early stages of recumbency. Perhaps 'pathetic' is too anthropomorphic a term to use. However, this cow holds her head low, is relatively bright, the ears are held back, and her hindlimb has not been flexed after her last attempt to rise. Very significant is the fact that she is lying on concrete covered with dry straw. When attempting to lift this animal, she simply hung lifeless in the slings.



**Figure 13-5** This animal is fairly representative of a cow that is referred to as a creeper. It is alert, active and has been treated for hypocalcemia. It is attempting to move forward on its knees and has sufficient use of its hindlimbs to 'collect' them under the body.



**Figure 13-7** This is a very unfavorable posture. Probably damage has occurred, bilaterally, to the adductor muscles. Possibly the animal has dislocated both hips. (Courtesy of B Welker)



**Figure 13-8** A limb with unilateral adductor muscle damage or hip dislocation may have a distinct crease in the thigh above the hock.



**Figure 13-9** Pain, swelling, abnormal posture, and crepitation on manipulating the limb provide conclusive evidence of a long bone fracture. (Courtesy of B Welker)

## Compartment Syndrome

This lesion results from constant pressure on the blood supply to a fibromuscular compartment. The venous outflow is affected considerably more than the arterial inflow. This is the rationale for rolling a very inactive recumbent cow from side to side as frequently as every 2 hours. The affected muscle bundle will feel extremely hard. If the cow remains lying down, the prognosis for recovery is very poor. Therefore, vigorous attempts must be made to get her to her feet. If the cow can be made to bear weight, her feet may need to be hobbled.

If a cow with compartment syndrome is able to stand, the only treatment is fasciotomy. The lowest part of the compartment should be selected for the site of the incision



**Figure 13-10** The upper fascial muscle bundle is normal in appearance. The pale coloration of the lower adductor muscle is indicative of muscular damage and the early stages of the compartment syndrome.

and due consideration should be taken of the positions of nerves and vessels around the site.

See Figure 13-10.

## Techniques for Obtaining Data on the Downer Cow

### Evaluation of Blood

It is not uncommon for a detailed examination to reveal no obvious cause of the recumbency. The information gained from blood samples can be particularly helpful if the recumbency continues for several days.

Hypokalemia and hypophosphatemia are commonly quoted causes of the so-called 'creeper cow.'

Elevated creatine kinase (CK) is a specific indicator of muscle damage. However, CK levels peak shortly after the commencement of muscle damage and decline noticeably within 4 hours. CK levels should be monitored at every visit to the patient. Plasma aspartate aminotransferase (AST) is also elevated in muscle-damaged cows. However, AST is also elevated when cardiac muscle is damaged.

In muscle-damaged cows, the urine may contain myoglobin as well as higher-than-normal levels of protein. Ketonuria and bilirubinuria may be detected also, but this would be associated with lowered feed intake. Serum glutamic oxaloacetic acid (SGOT) levels are usually markedly elevated 18–24 hours after the onset of recumbency.

Both hypocalcemia and the downer cow syndrome are rare in beef cattle, therefore, traumatic injuries are the most likely cause in this group of animals.

### Ultrasonography

Ultrasonography has not, to date, had an important practical application for the diagnosis of lameness in cattle. However, ultrasonography can be used to evaluate injuries to the tendons and ligaments, and it may prove of value in identifying radiolucent foreign bodies and in tracing sinus tracts and deep abscesses, particularly within large muscle masses.

### Electromyography

Electromyography (EMG) can be used to detect failure in the nerve supply to muscles. Portable equipment is available for use on the farm, but detailed studies are still best conducted in a referral facility. Information collected is based on the following points. Denervation potentials may not appear until 1 week after an injury and usually reach greatest activity by the third or fourth week. EMG examination can detect the degree of lower motor neuron disease before clinical signs appear. Active myositis gives a positive EMG response. Degenerative muscle disorders (e.g., white muscle disease) are usually negative on EMG examination. Estimates of rate of recovery can be made before there is any clinical evidence of such.

## Treatment of the Downer Cow

### Medication

If an apparently hypocalcemic cow fails to respond to calcium therapy, not only calcium but phosphorous, magnesium, and potassium should be given as a second treatment, pending the results of laboratory tests. Monitoring the blood mineral status is an important part of the ongoing management program for a downer cow.

### Animal Care

If the patient has become recumbent on a concrete surface, the footing must be immediately improved. Nine inches of wet manure should be placed on the floor and covered with a substantial layer of dry straw.

The animal must be kept propped in sternal recumbency at all times. This is usually accomplished by wedging bales of straw behind the shoulder.

The cow must be moved from one side to the other every 2 hours. This is often a problem with a heavy animal because the hindlimb on the side on which it is lying often slips from beneath the body, propelling the animal into lateral recumbency. This protruding limb has to be drawn under the body before the animal can be turned. This can be done with the help of a rope that is literally 'sawn' to and fro beneath the body. One end of the rope

should emerge from beneath the shoulder on which the animal is lying and the other end tied around the pastern of the problem limb. The leg is then pulled under the body and the free end taken over the shoulder to the other side of the cow. Pulling on this end rolls the cow on to her chest.

If the patient is confined in a small box, particularly if the footing is bad, or is recumbent for more than 12 hours it must be removed to a specially prepared location. This location should be protected from the elements, have superior footing, and have no artificial barriers that may inhibit the desire to rise. Hay barns with an earthen floor, pasture during favorable climatic conditions, or well-bedded corrals or loose houses are suitable.

Moving a recumbent cow requires time, care, and attention to detail. There are two phases involved – sliding the animal a short distance and then loading it onto a transportation device:

1. To remove a cow from a loose box, first place a thick layer of very dry straw between the cow and the exit from the box. Turn the animal onto its side with her head facing the exit. Apply a rope to the limb on which the animal is lying and fit a halter to prevent the head touching the ground. Pull on the extended lower forelimb and slide the animal out of the box.
2. The most commonly used device to transport a cow some few hundred yards is the front end loader of a tractor. Alternatively, a farm gate covered with a canvas tarpaulin and a thick layer of straw makes an excellent sledge. The cow is slid onto the device, taking care that dependent parts, particularly the ears, are protected by the tarpaulin.

### Nursing

Good nursing practice is essential. Provide fresh clean water and change it every 2–3 hours, preferably in a shallow rubber feed bowl to minimize spillage. If the patient fails to drink, she must be given fluid either by drench or parenterally.

Dealing with an animal's refusal to eat takes patience. Never offer too much feed. Remove feed if it is refused for 30 minutes and try again. If a cow salivates on feed (or water) she will never eat it subsequently. Sweet hay is usually the most acceptable feed for a sick cow. Ivy or dandelion placed in the mouth may provoke salivation and an interest in eating.

In extreme cases, the cow can be drenched with rumen transplant (fresh rumen contents obtained from the slaughterhouse). Sometimes drenching with a thin gruel, to which a tablespoon of powdered ginger and/or gentian has been added, can be helpful.





**Figure 13-11** Cows facing a wall or into a corner have insufficient lunge place to be motivated to rise. Dry straw, however deep, on a concrete surface does not provide adequate grip. The cow must be moved to a location with an appropriate surface. (Courtesy of B Welker)

If the weather is cold and blustery, a quilt is valuable. These are constructed from six gunny sacks stuffed with hay and stitched together at their edges by means of binder twine. The quilt is kept in place by loops of binder twine around each leg.

See Figures 13-11 and 13-12.

### **Lifting the Cow**

On every day of the recumbency, an attempt should be made to bring the cow to her feet. Recently calved cows can be motivated to rise if they hear their own calf bawling with hunger. The calf is best restrained close to the cow.

Bumping the cow in the ribs behind the shoulder with the knees of the operator is a good mild stimulus. Shouting in the animal's ear may help. Painful stimuli are of doubtful efficacy. If the cow does attempt to rise, helpers should be ready on either side of the animal to stabilize her. Lifting on the flanks or tail is counterproductive. If space appears under the animal, a rope can be slung under the belly and added lift can be provided.

The proper use of hip clamps requires experience, skill, and a very delicate touch. If a front-end loader is not available, a T-bar suspended by a pulley from an overhead beam will serve. In open spaces, a tripod can be constructed from poles from which a block and tackle can be suspended. There is a trick to using the hip clamp (or slings). A helper should stand on either side of the



**Figure 13-12** The location of choice will be shaded from the elements and have an excellent footing. Appetizing feed and plenty of fresh water should be provided. (Courtesy of Anon)

animal at the shoulder in order to prevent the cow from swaying from side to side. As the cow is lifted, her hindlimbs are likely to be somewhat flexed. If this is the case, the cow should be lifted almost to the height at which the feet are touching the ground. At this point, one leg is extended and placed in the normal weight-bearing posture. The weight of the hind end should then be transferred to that leg and the other limb straightened in a similar manner. This process may have to be repeated several times before the cow gets the feel of her hindlimbs. When this happens, a mild stimulus may stir her to conscious action. It is important not to persist with this procedure for too long at any one time – if the cow simply hangs inert in the apparatus for 2 or 3 minutes, it is preferable to abandon the attempt and try again in 12 or 24 hours.

See Figures 13-13–13-15 and Figures 13-16–13-18.

### **Prevention**

It is generally believed that most downer cows are probably a complication of hypocalcemia. Therefore, it follows that all mature dairy cows must be monitored very closely during the post-partum period. The elapse of several hours from the commencement of clinical signs of milk fever until treatment seems to be the critical issue. The use of television surveillance of recently calved cows seems to be a prudent measure.



Figures 13-16, 13-17, 13-18 Inflatable balloons provide a new, non-traumatic method for lifting a downer cow. (Courtesy of C Bergsten)

Figures 13-13, 13-14, 13-15 The value of hip clamps is controversial.

## PERIPHERAL NEUROPATHIES

### KEY CONCEPTS

- Most peripheral neuropathies are characterized by being asymmetrical.
- They are caused by prolonged recumbency, trauma, and calving injuries.

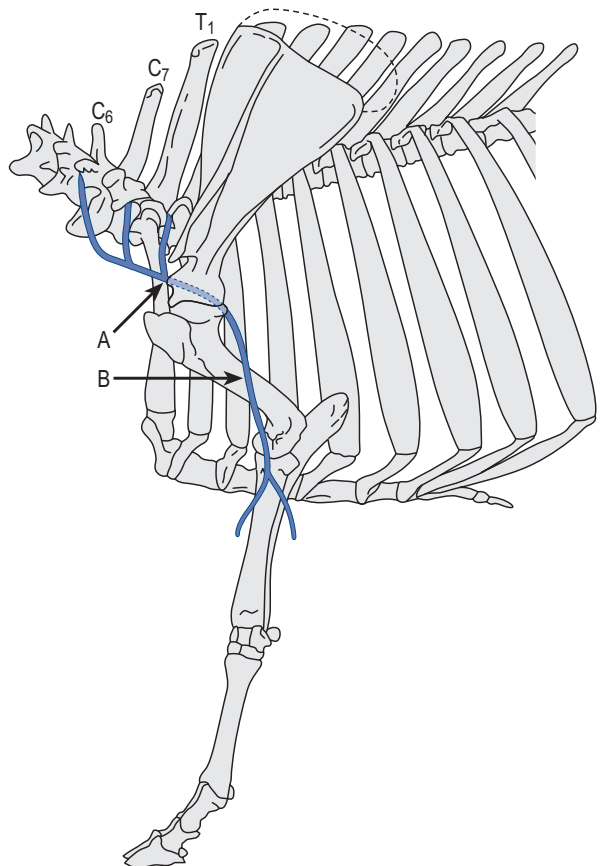
## Radial Paralysis

### Description

The radial nerve (Fig. 13-19) can be accidentally damaged in two ways. Most commonly the nerve is damaged at the point of the shoulder where it crosses the first rib. If the nerve becomes trapped in a fractured first rib, the injury is likely to be permanent. The most frequent nerve damage follows constraint by means of ropes or from casting the animal and forcibly pulling the forelimb backwards. In this case, the shoulder and elbow will be dropped and the dorsal surface of the limb dragged behind the animal.

If the nerve is damaged at the point at which it turns around the shaft of the humerus, the shoulder and elbow will be held in the correct position, but the digits will be flexed.

No pain is elicited when the limb is manipulated. There may be a history of trauma to the shoulder region, the animal may have been cast with ropes, or it may have



**Figure 13-19** The radial nerve innervates muscles that flex the shoulder and elbow as well as extends the digits. It is vulnerable at two points: (A) where the nerve crosses the first rib, and (B) where the nerve rolls around the mid-shaft of the femur.

been lying on an operating table for some period of time. For young animals, a radiographic examination will be useful to eliminate the possibility of bone fractures.

See Figures 13-20 and 13-21.

### Cause

This neuropathy is sometimes referred to as a casting paralysis. Unskilled use of ropes is a common cause. The nerve is forcibly stretched around either the first rib or the shaft of the femur. The problem is made worse if the animal struggles violently. Animals that are hobbled for a prolonged period are also susceptible to radial nerve injury.

Direct trauma caused when an animal hits its shoulder by running into a solid obstruction can also cause radial paralysis. The nerve runs around the first rib, therefore it is possible that it can be crushed when traumatic pressure is applied. Occasionally, the first rib may be fractured and the nerve can be caught and injured by a rough edge of bone. Fracture of the humerus can also affect the radial nerve, but in these cases the animal will experience pain when the limb is manipulated.



Figure 13-20 If the radial nerve is damaged at a high level, the shoulder and elbow drop and the animal is unable to extend its limb which may drag on the ground. (Courtesy of B Welker)



Figure 13-21 If damage to the radial nerve takes place distal to the mid-shaft of the humerus, only extensors of the digit will be affected. (Courtesy of Anon)

### Treatment

In most cases, there will be noticeable improvement if the animal is rested in a well-bedded area. Failure to isolate the animal is likely to result in additional injuries from slipping or contact with other animals. If there is no improvement within 7 days, it is likely that extensive injury has taken place and the possibility of recovery will be unlikely.

## Ischiadic Paralysis (Sciatic Paralysis)

### Description

If the paralysis is associated with compression of the nerve inside the pelvis during a prolonged parturition, both limbs may be affected. When this is the case, it can be the primary cause of downer cow syndrome.

If the animal is ambulatory, the disorder may affect only one limb. The hock will drop due to extension of the gastrocnemius muscle, and paralysis of the extensors of the digit will cause the dorsal surface of the fetlock to touch the ground. The ischiadic nerve branches to form the peroneal and tibial nerves; therefore, differentiation from the clinical signs caused by paralysis of these nerves can complicate diagnosis. The quadriceps femoris supplied by the femoral nerve will be unaffected.

If the clinical signs are not parturition related, a traumatic cause must be investigated. In mature animals, a rectal examination may reveal a fracture of the pelvis or some other abnormality.

See Figures 13-22 and 13-23.

### Cause

The ischiadic nerve can be damaged during parturition at a point at which the L6 root exits the pelvic canal over



**Figure 13-22** This crouching posture is indicative of slight bilateral ischiadic paralysis in a recently calved cow. In a non-parturient animal, spinal impairment would be suspected. (Courtesy of B Welker)



**Figure 13-23** This is a recently calved cow which has a dropped hock and knuckling at the fetlock. This could be a case of unilateral ischiadic paralysis, but is more likely tibial paralysis. (Courtesy of Anon)

the ischiadic notch on the wing of the ilium. Pelvic fracture can also lead to damage of the nerve. The nerve then passes over the deep gluteal muscle and plunges deep into the gluteobiceps muscle. Particularly in poorly muscled calves, intramuscular injections (or associated abscesses) in this region can interfere with the normal function of the nerve. Oil-based products may result in irreversible damage.

### Treatment

The only course open is to see if time will allow healing.

### Obturator Paralysis

#### Description

Caution should be exercised before making the diagnosis of obturator paralysis based on the alleged typical posture seen in Figure 13-24. The obturator muscle is so small that it is more likely to cause staggering and difficulty walking than to cause downer cow. If the animal is

standing, it will probably do so with both hind legs spread well apart. The animal may slip and fall as it attempts to progress. The patient found recumbent with its hindlimbs spread-eagled (Fig. 13-24) is most likely to have damaged other adductor muscles in addition to the obturator. The animal will be bright and may be elevated on its forelimbs. There will usually be a history of recent calving. Differentiating the clinical signs from those caused by ischiadic paralysis may be difficult.

The condition is most commonly observed in relatively small heifers with large calves.

**Cause**

Paralysis of the obturator nerve is caused by crushing pressure exerted when a large calf passes through the pelvis. Some concurrent damage to the ischiadic nerve is quite likely.

**Treatment**

Unless complications supervene, natural resolution of this condition is likely. However, quite often the recumbency is mismanaged and irreversible damage to the adductor muscles occurs. Therefore, it is essential that vigorous measures be taken to avoid further damage. The affected animal must be removed immediately to a high-friction locale such as pasture or a hay barn with an earthen floor. Failing these possibilities, a large loose box should be bedded with 6 inches (15cm) of well-rotted manure, covered with 6 inches (15cm) of straw. Under no circumstances should the animal be encouraged to struggle to rise.

**Femoral Paralysis**

**Description**

If the patient is a calf, there is likely a history of forced traction and possible information regarding hip or stifle lock. The animal will have difficulty standing which



Figure 13-24 The spread-eagled position taken by the animal in this picture is considered by many to be typical of obturator paralysis.

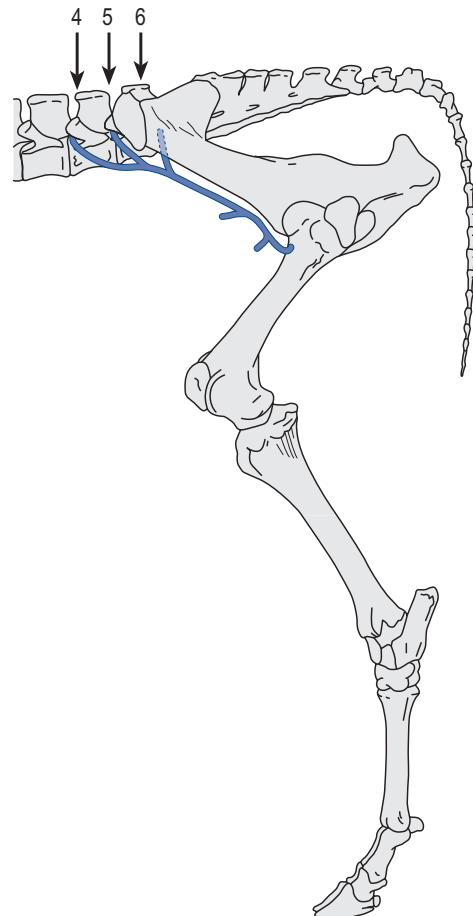


Figure 13-25 The femoral nerve of a calf can be crushed against the pelvis during a hard calving.



**Figure 13-26**  
Noticeable wasting of the quadriceps femoris muscle group. (Courtesy of B Welker)



**Figure 13-27** An animal with femoral paralysis has difficulty flexing the stifle. (Courtesy of J Ferguson)

may compromise suckling. The stifle will appear to have dropped. As the condition progresses, the quadriceps femoris muscles will atrophy. One or both hindlimbs may be affected. It is wise to use radiography to eliminate the possibility of bone fractures.

See Figures 13-25–13-27.

### Treatment

If complications do not supervene, an animal affected with femoral paralysis is likely to recover. However, usually patients are extremely weak, which makes good nursing a critical factor. If the animal is unable to suckle properly, it must be given colostrum. It should be located in a well-bedded location protected from the elements.

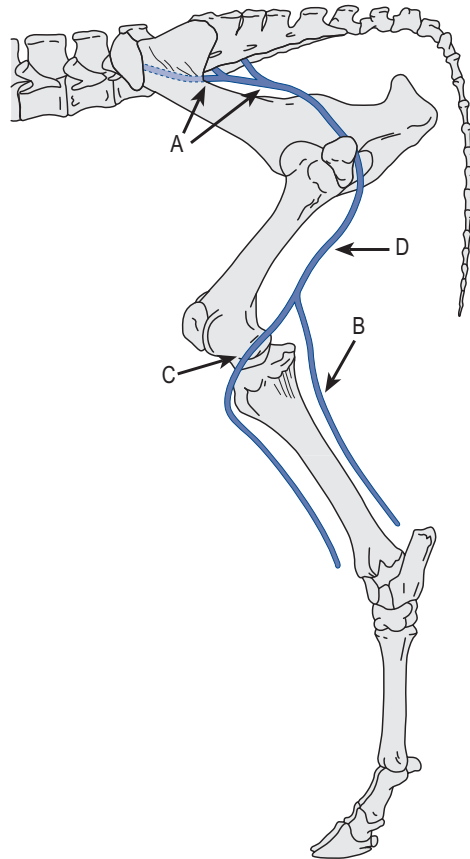
## Peroneal Paralysis

### Description

Peroneal paralysis is perhaps the most common of disorders affecting the peripheral nerves of the limbs of cattle. With this condition the fetlock is markedly flexed, so much so that the apex of the claw may be dragged on the ground, causing it to show signs of wear.

This condition can be confused in appearance with ischiadic paralysis. Lower limb reflexes would be absent if paralysis of the ischiadic nerve were the cause. There may be a decrease in the sensation of the dorsal surface of the fetlock.

See Figures 13-28 and 13-29.



**Figure 13-28** The ischiadic nerve is vulnerable to pressure from a calf during parturition at point A. The nerve is also vulnerable as it passes down the limb to damage from an injection D. The nerve divides: the anterior branch is the peroneal nerve, which is vulnerable to damage as it passes over the lateral condyle of the femur at point C. This point is easily damaged if a cow struggles on a hard surface. The caudal branch of the ischiadic nerve is the tibial, which runs between the bellies of the gastrocnemius muscle at point B.



Figure 13-29 Paralysis of the peroneal nerve affects the extensors of the digit and the animal 'knuckles' at the fetlock. (Courtesy of Anon)

#### Cause

This disorder may be associated with recumbency and/or there may be evidence of decubital lesions in the region of the stifle.

#### Treatment

As with many peripheral nerve paralysees of the limb, resolution will be the norm unless complications supervene. For this reason, it is important to stress that care must be taken to ensure the animal can maintain an ambulatory state.

### Tibial Paralysis

#### Description

The characteristic feature of this nerve paralysis is dropping of the hock (Fig. 13-30). There is also a tendency for the fetlock to flex – but not to such an extreme degree as is the case with peroneal paralysis (with which the disorder may be confused). The condi-

tion can be confused with damage to the gastrocnemius muscle or rupture of the Achilles tendon. There may be a history of an injection being made into the musculature caudal to the hock, in which case tissue reaction may be detected by deep palpation.

#### Cause

The tibial nerve branches from the ischiadic nerve caudal to the stifle, where it is well protected by the gluteobiceps muscles. It innervates parts of the flexor system and the gastrocnemius muscle. Extensive trauma to the gastrocnemius muscle can involve the tibial nerve. However, although this nerve is relatively superficial as it progresses distally beneath the Achilles tendon, its function is then almost entirely sensory. Therefore, trauma to the tendon of the gastrocnemius muscle is not associated with tibial paralysis. A more likely cause is deep injections into the back of the thigh. For much of their course the tibial and peroneal nerves run close together, therefore, a mixed paralysis might be observed.



Figure 13-30 Paralysis of the tibial nerve relaxes the gastrocnemius muscle allowing the hock to sink. The fetlock flexes to some extent. (Courtesy of Anon)



## Treatment

Many cases will recover spontaneously. However, an abscess or severe tissue reaction caused by an injection may result in pressure on the nerve which can persist for some time.

---

## BIBLIOGRAPHY

- Al-Badrany M S 2000 Clinical and biochemical differences between milk fever and downer cow syndrome. *Iraqi Journal of Veterinary Sciences* 13:387–392
- Baker J C (ed) 1987 Bovine neurology. *Veterinary Clinics of North America: Food Animal Practice* 3:1–216
- Bundza A, Dukes T W, Stead R H 1986 Peripheral nerve sheath neoplasms in Canadian slaughter cattle. *Canadian Veterinary Journal* 27:268–271
- Chamberlain A T 1987 The management and prevention of the downer cow syndrome. *Proceedings of the British Cattle Veterinary Association*, p 20–30
- Chamberlain A T 1986 Prognostic indicators in the downer cow. *Proceedings of the British Cattle Veterinary Association*, p 57–68
- Ciszewski D K, Ames N K 1987 Diseases of peripheral nerves. *Veterinary Clinics of North America: Food Animal Practice* 3:193–212
- Cordy D R 1986 Progressive ataxia of Charolais cattle – an oligodendroglial dysplasia. *Veterinary Pathology* 23:78–80
- Correa M T, Erb H N, Scarlett J M 1993 Risk factors for downer cow syndrome. *Journal of Dairy Science* 76:3460–3463
- Cox V S, McGrath C J, Jorgensen S E 1982 The role of pressure damage in pathogenesis of the downer cow syndrome. *American Journal of Veterinary Research* 43:26–31
- Cox V S 1988 Non-systemic causes of the downer cow syndrome. *Metabolic diseases of ruminant livestock. Veterinary Clinics of North America: Food Animal Practice* 4:413–433
- Cox V S, Marsh W E, Steuernagel G R et al 1982 Downer cow occurrence in Minnesota dairy herds. *Preventive Veterinary Medicine* 4:249–255
- De Lahunta A 1983 *Veterinary neuroanatomy and clinical neurology*, 2nd edn. W B Saunders Co., Philadelphia
- Doige C E, Townsend H G G, Janzen E D, McGowan M 1990 Congenital spinal stenosis in beef calves in Western Canada. *Veterinary Pathology* 27:16–25
- Dowling P, Tyler J W, Wolfe D F, Purohit R C, Steiss J E 1991 Thermographic and electromyographic evaluation of a lumbosacral spinal injury in a cow. *Progress in Veterinary Neurology* 2:73–76
- Harwood J P P 2003 Tackling the problem of the downer cow: cause, diagnosis and prognosis. *Cattle-Practice* 11(2):89–92
- Greenough P R, MacCallum F J, Weaver A D 1981 Lameness in cattle, 2nd edn. J B Lippincott Co., Philadelphia p 337–365
- Lefebvre H P, Toutain P L, Serthelon J P et al 1994 Pharmacokinetic variables and bioavailability from muscle of creatine kinase in cattle. *American Journal of Veterinary Research* 55:487–493
- Mayhew I G 1989 Large animal neurology. A handbook for veterinary clinicians. Lea & Febiger, Philadelphia
- Oliver J E, Horlein B F, Mayhew I G 1987 *Veterinary neurology*. W B Saunders, Philadelphia
- Palmer A C 1984 *Introduction to animal neurology*, 2nd edn. Blackwell Scientific Publications, Oxford
- Paulsen D B, Noordsy J L, Leipold H W 1981 Femoral nerve paralysis in cattle. *Bovine Practice* 2:14–26
- Rebhun W C, de Lahunta A, Baum K H et al 1984 Compressive neoplasms affecting the bovine spinal cord. *Comparative Continuing Education Practicing Veterinarian* 6:S396–S400
- Schneider R K, Bramlage L R 1990 Suprascapular nerve injury in horses. *Comparative Continuing Education Practicing Veterinarian* 12:1783–1789
- Steiss J E, Argue C K 1987 Normal values for radial, peroneal and tibial motor nerve conduction velocities in adult sheep with comparison to adult dogs. *Veterinary Research Communication* 11:243–252
- Stuart L D, Leipold H W 1983 Bovine progressive degenerative myeloencephalopathy ('weaver') of Brown Swiss cattle I, II. *Bovine Practitioner* 18:129–132, 133–146
- Taylor H W, Vandeveld M, Firth E C 1977 Ischemic myelopathy caused by fibrocartilaginous emboli in a horse. *Veterinary Pathology* 14:479–481
- Vaughan L C 1964 Peripheral nerve injuries: an experimental study in cattle. *Veterinary Record* 76: 1293–1304
- Wells G A H, Hawkins S A C, O'Tool D T et al 1987 Spastic syndrome in a Holstein bull: a histologic study. *Veterinary Pathology* 24:345–353
- White M E, Whitlock R H, de Lahunta A 1975 A cerebellar abiotrophy of calves. *Cornell Veterinarian* 476–491

# Claw Trimming, Foot Baths, Restraint, Bandaging, Lifts, and Shoes

## FUNCTIONAL CLAW TRIMMING

### KEY CONCEPTS

- Form a mental picture of the proportions and angles of a normal claw and cut your way towards that ideal.
- The milk yield should not drop more than 2lb for a maximum of 2 days immediately after trimming and should actually increase thereafter. This is the benchmark of a competent claw trimmer.

### Introduction

Improving claw health is achieved by expert claw trimming carried out on a routine basis. Conversely, poor trimming technique is detrimental to the soundness of the claws. The primary foot care specialists in most countries are the claw trimmers. However, the claw trimming profession is not licensed or accredited, therefore, care must be exercised in selecting individuals who are well trained and competent.

Some producers may believe that they are able to trim a cow's foot as well as anyone else but this is not the case. The majority of trimmers are experienced, able to recognize and treat common foot lesions and document their findings accurately. They use and maintain the most suitable equipment needed to provide a responsible service.

In many countries the law is unclear about the status of claw trimmers in respect to regulations governing veterinary practice. This has led to some conflict between the trimmers and the veterinary profession. Laws controlling the delivery of health care to animals have two main objectives

– first, the protection of the public from individuals claiming skills they do not possess and second, protecting the wellbeing of animals. There may be a gray area in the interpretation of the law. In most countries, only a veterinarian, other than the owner of the animal, may legally diagnose and treat an animal. The claw trimmer is not qualified to offer advice on controlling risk factors that are associated with a herd lameness problem. Neither is the claw trimmer skilled at performing invasive surgery of the digital region. Most trimmers are fully aware of these distinctions.

A competent claw trimmer is in a unique position to regularly document information about claw lesions. These data can be incorporated into herd health records and are invaluable for investigating problems when the incidence of lameness is very high. The future of data recording probably lies with palmorders (palmtop computers) which will interface with suitable databases loaded in a PC. However, for the time being recording data on paper still remains the most efficient system.

The main reason that routine claw trimming is important is that it relieves pain caused by an overgrown claw. Improving the wellbeing of the cow has a direct positive effect on milk production and on reproductive efficiency. Removal of even a thin layer of horn from the sole stimulates the production of new, healthy, resilient horn. Newly exposed horn surfaces have a greater friction factor than old horn and this contributes to the animal's sense of stability and wellbeing.

Functional trimming is a system based on scientific principles first developed in the Netherlands by the late Professor Egbert Toussaint-Raven. This basic method of trimming is taught at the School voor de Veehouderij en het Weidebedrijf in Oenkerk (now IPC) in the Netherlands. This institution has been responsible for functional claw trimming being adopted world wide.

## The Normal Morphology of the Bovine Claw

The characteristics of claws needing to be trimmed are unique to each animal and bear little resemblance to normality. Nevertheless, the trimmer will have a mental picture of the optimal model claw. The parameters of such a precise model are difficult to define in words.

Under the pastoral conditions of bygone ages the claws of mature cattle encountered few abrasive surfaces in the lush water meadows on which they grazed. Under those conditions the bearing surface of the wall of the claw was pronounced. The sole appeared to be hollow; its

surface flaked away naturally and was packed with a protective pad of mud and grass. The claw was in a state of 'homeostasis' in which horn growth balanced horn loss.

Under today's conditions of intensive management the balance between growth and wear becomes distorted. What is taken to be a normal shape today has often been re-molded by an abrasive environment. Environmental conditions for managing dairy herds vary throughout the world. The environment varies from concrete floors to filthy feedlots. The growth of claw horn varies according to the stimulation of wear and pressure or to the intensity of the nutrition. Wear of the claw capsule is also dictated by subclinical laminitis, moisture, irritants in slurry, and the characteristics of artificial (concrete) surfaces.

See Figures 14-1–14-4.

## The Concept of Functional Claw Trimming

### GLOSSARY

- Load:** The proportional distribution of weight on the solear surface of the claw.
- Overloading:** An increase in pressure on the dermis of the sole due to abnormally thick or irregular sole horn. Overloading also occurs on the abaxial wall as the result of abnormally thick solear horn.
- Overburdening:** An obvious build up of horn at the heel.

### KEY CONCEPT

- The first priority must be to unload the lateral hind claw and transfer weight to the medial claw.

The functional claw trimming method offers a rational, logical system for achieving good results if the trimmer has a sound mental picture of the ideal model claw. The ideal model claw for cows managed on concrete will be different from those that are managed on pasture. The trimmed claw must enable the animals to feel



**Figure 14-1** The soles of the claws of a young cow. The soles are slightly concave and slope toward the axial border. The axial borders tends to be slightly concave. The claw on the right is the lateral digit and tends to be slightly larger than the medial. The heel bulbs are well rounded and fully functional.



**Figure 14-2** From side view the dorsal border of the claw is straight, not concave. The deep abaxial groove marks the line of demarcation between the wall and the bulb of the heel. Normally, the claw may bear light ridging or even a noticeable groove.

secure when it walks (not rests) on a hard unslippery surface. The objectives of functional claw trimming are two-fold:

- First, balanced weight-bearing must be re-established between the two claws on each foot. This provides lateral stability.
- Second, an equal distribution of the load must be restored to the length of the claw. This provides longitudinal stability which is an attribute of a single claw. The overloaded claw cannot be relieved if the claw which will have to carry the weight is not stable under load, both longitudinally and laterally.

The basic assumption is that a 'long' claw has to be trimmed at the toe in order to intensify load-bearing on the abaxial and dorsal borders of the wall.

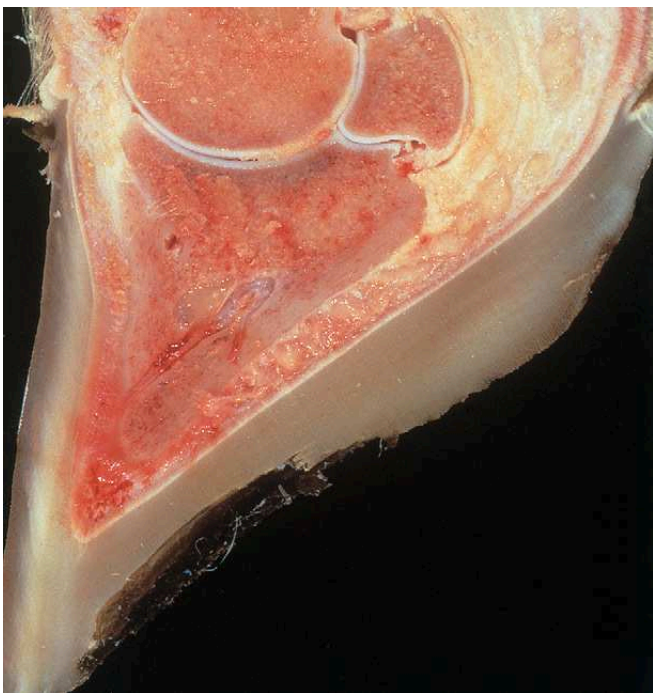
## An Analysis of the Problem

### KEY CONCEPTS

- Visualizing a mental picture of the parameters of a normal heel and sole is an essential prerequisite for the claw trimmer who will invariably be presented with an abnormally shaped claw.
- The objective of trimming is to reduce the height of an overburdened lateral hind claw in order to transfer an appropriate part of the load to the ipsilateral (companion) normal claw.
- Claw trimming should not be performed by individuals who milk the cows. The procedure should not take place in any location that the cows would normally associate with milking. These two factors might interfere with milk let-down in some cows.



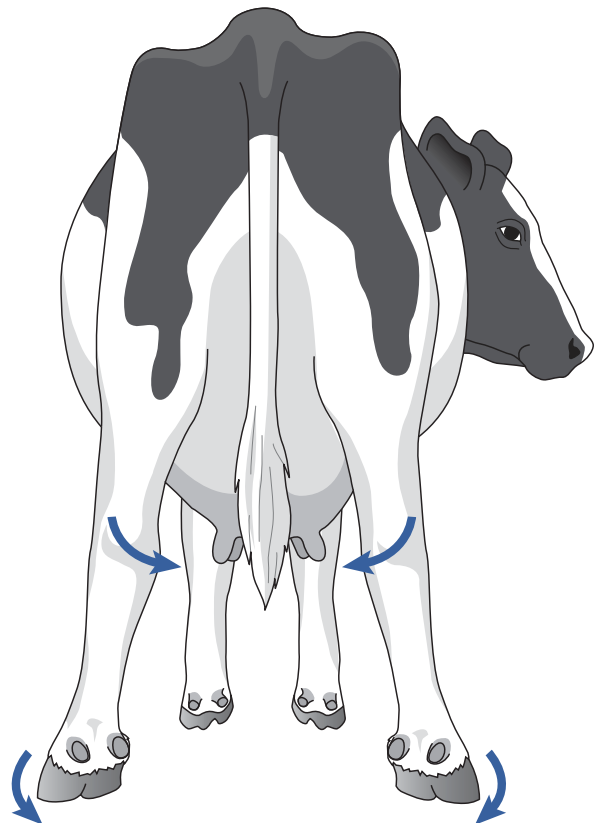
**Figure 14-3** Notice that the axial wall is smaller than the abaxial wall. However, as the animal bears weight the claws will spread apart and then the axial wall will contact the ground. This picture emphasizes the importance of the concavity of the claw.



**Figure 14-4** This cross section of a normal claw shows that the anterior part of the sole is thinner in than the horn below the heel.

Each time a cow takes a step on a hard slippery surface the hind foot slides outwards, changing weight distribution between the two claws. Inevitably, the lateral hind claw takes more weight and eventually becomes overloaded and the sole increases in width. The resulting pressure on the dermis of the claw stimulates horn production, which in turn increases the thickness of the horn beneath the bulb (overburdening). Increased horn production can also result in a 'long' claw as well as a thick heel.

Overburdening (of the heel, Figs 14-5 and 14-6) is a mechanism which, in hind feet, causes the hocks to turn in and become 'cow hocked.' The 'cow hocked stance' is a posture, a voluntary pose the cow uses to relieve discomfort from the overloaded outer hind claws. It is not uncommon to see this posture to return to near normal stance immediately after corrective trimming.



**Figure 14-5** A large udder forces a cow to move her hindlimbs outwards and back. This tends to rotate the limb inwards and change load between the claws. Gradually the heel horn increases in thickness (overburdening) and the hocks turn inwards.

An overburdened lateral hind claw literally lifts its less developed companion from the ground, further decreasing the amount of the weight carried by the smaller claw. Furthermore, overburdening creates a vicious circle causing more weight to be shifted from the front of the claw to the back. It also predisposes the claw to pathological change such as a sole ulcer in tethered stalls or a white line separation in loose housing systems.

Once functional trimming has been performed, the load on the outer hind claws will be diminished, allowing the stressed dermis time to heal. However, the cause of the problem (walking on hard surfaces such as concrete or hard soil) will continue and eventually overgrowth, overloading, and overburdening will occur once more.



**Figure 14-6** The heel of the claw on the left is much thicker than that on the right. This is referred to as 'overburdening.'

## Trimming for Longitudinal Stability

### GLOSSARY

**Heel Height:** The vertical distance from the ground to the hairline at the back of the heel. This distance averages 3.8cm in a mature Holstein cow but decreases as the animal ages.

**Claw Diagonal:** The distance from the apex of the claw to the hairline at the abaxial groove. This distance varies between 10cm and 14cm in a mature Holstein cow and is considered to be highly heritable (see Chapter 12).

**Proportionate Overgrowth:** This is said to occur when the length of the toe and height of the heel of both claws increase at relatively the same rate such as in animals kept on soft pack (see Figs 14-7 and 14-8).

**Disproportionate Overgrowth:** This is overgrowth that disproportionately increases the size of the lateral claw relative to the medial claw, as is usually seen in animals housed in free stalls.

### KEY CONCEPTS

- The longitudinal stability of a claw can be described as the equal balance of the load on the claw between the anterior and posterior halves of the claw. The key to establishing longitudinal stability is to create the most desirable heel height/claw length ratio possible.
- If a claw appears to be 'funny,' 'strange,' 'awful,' or just plain 'ridiculous' leave it longer than ideal and leave it thicker at the toe than ideal.

The strength of the claw capsule depends as much on its dimensions as it does on the quality of horn: the thicker the stronger. This means that, before trimming, a precise evaluation of the dimensions of the claws has to be determined.

There is an important relationship between the height of the heel and the length of the bearing surface of the wall. In principle, the lateral hind claw should be kept as high as possible at the heel while also maintaining this desired relationship.

If a claw tilts backwards under load, the anterior bearing surface is too short. Therefore, the heel will have to be lowered in order to compensate for the imbalance. Conversely, the longer the bearing margin of the wall the higher must be the heel. For this reason no predetermined values can be given for an optimal claw length between the height of the heel and the length of the bearing surface of the wall

The overall accepted length of the dorsal wall of the claw of an adult Holstein Friesian female is 7.0–8.0cm. The measurement should be taken along the flexure of the dorsal surface of the wall from the point beneath the hairline at which the wall can be clearly felt to the apex of the claw.

- *Step One:* Cut the tip of the toe perpendicular to the bearing surface of the claw in order to reduce the dorsal wall to its normal length (7–8cm). If the cut is executed correctly approximately 5–7mm of the sole will be exposed. Cutting the length of the claw too short or reducing the length on principle, even if the claw is already short, is a common error.
- *Step Two:* Remove excess wall and sole from beneath the *anterior* half of the claw. The area that is created in the anterior 25% of the sole as a result of undercutting is referred to as the toe triangle. The area must be flat and at right angles to the metatarsus/metacarpus (Figs 14-10–14-12).



Figures 14-7 & 14-8 The simplest form of overgrowth (proportionate overgrowth) is seen in animals confined in yards where the walking surface consists of packed manure and straw. Horn growth continues normally but there is little or no wear taking place. In this extreme case weight-bearing has been transferred to the posterior region of the claw and the pedal joint is over extended.

Undercutting the sole beneath the apex must not completely eliminate the end of the claw exposed in step one. Inexperienced workers often continue the undercutting right back to include the posterior part of the abaxial wall. This is poor technique as more often than not too much of the heel is removed. Trimming the posterior part of the sole and wall *must* be left until lateral stability is being established.

The thickness of the sole must be evaluated continuously throughout the trimming procedure. Normally an untrimmed sole will not yield to strong compression with the thumb. If any part of the sole feels compressible no further cutting should take place in that area.

See Figures 14-9-14-12.

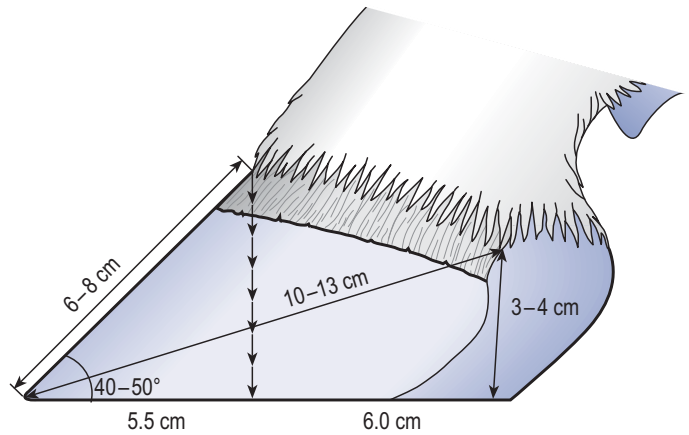


Figure 14-9 The centre of gravity of a normal claw is located (more-or-less) at a vertical point in the middle of the sole.

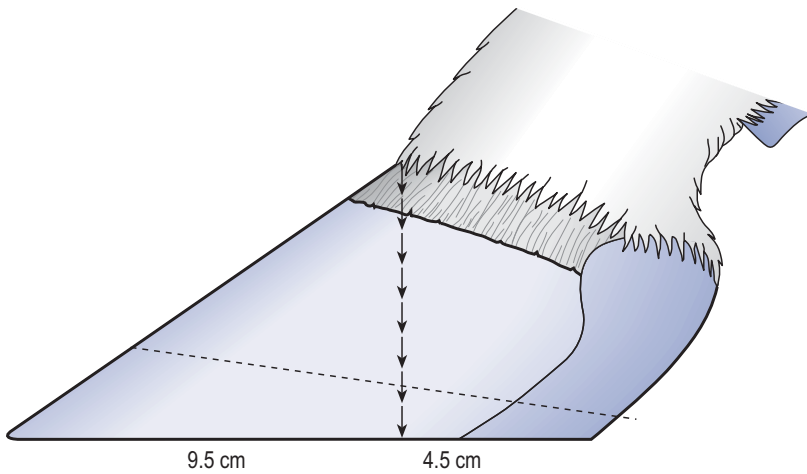


Figure 14-10 This is a drawing of an overgrown claw. Note that the centre of gravity has moved posteriorly. More weight is now borne by the heel which does double duty as a shock absorber. Note also that the angle between the dorsal wall and the bearing surface of the claw is decreased.



Figure 14-11 The apex of the claw is cut off in a plane vertical to the bearing surface at a point on the dorsal surface of the claw more-or-less 7.5cm from the hair line. The operator will then remove excess wall and sole from beneath the *anterior* half of the claw.

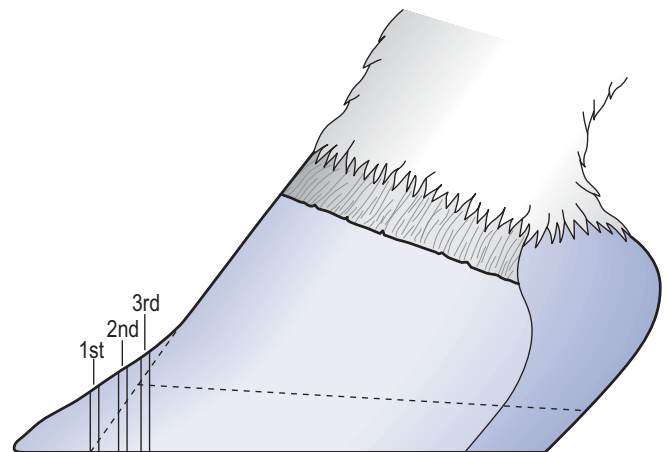


Figure 14-12 If the dorsal wall of the claw is concave (buckled claw) inexperienced workers would be advised to reduce the length of the dorsal wall by a series of cuts about 1cm thick. The reason for this is that the pedal bone may have molded over time or there maybe sinkage of the apex of the bone. In other words the exact location of the pedal bone may be uncertain.



## Trimming for Lateral Stability

### GLOSSARY

**Bearing Surface:** Under normal circumstances the animal's weight (load) on the solar surface of the sole should be confined to the wall and about 1cm of the bordering sole plus the under surface of the heel (pad).

**Pad:** This is the bar of horn beneath the heel which transmits the shock of locomotion to the digital cushion and other structures of the pedal bone support system (see p. 20) inside the claw.

**Lateral Stability:** This is the resistance to the tendency for a foot to slide away from the body on slippery surfaces.

### KEY CONCEPTS

- Correcting lateral stability is the most important objective in trimming claws. Many inexperienced workers fail to grasp the principle that in a hind foot the medial claw must be left higher than the trimmed lateral claw. How much higher depends on the dimensions of the claws before trimming, how much load the medial claw can manage and on the amount of relief needed by the outer claw.
- Rasping away the surface of the abaxial wall to improve the appearance of the claw is contraindicated as the surface layers of the wall hold in moisture. Removal of the surface layer allows the horn to dry out and become brittle.
- Claws are very often over-trimmed. The late Egbert Toussaint-Raven once said, 'I sometimes have the idea that people can't bear to see something that is normal and have to modify it according to their own personal taste.'

Lateral stability depends on two factors:

- (a) *Establishing longitudinal stability.* This will have ensured that the dimensions of the bearing surface are as large as possible at the toe. At the

toe the bearing margins of the axial and abaxial wall support much of the load at rest because the suspensory apparatus of the digit is most extensive in this region. The bearing margin of the axial wall is only about 2.5cm long but has a very important function.

- (b) *The direction of the loading forces.* In the untrimmed foot, these gradually change from being vertical to the metatarsus to being directed outward or away from the midline. When this happens the abaxial wall of the lateral hind claw wears less and grows longer, causing the bearing surface to widen. Gradually weight-bearing is taken less by the abaxial wall and more by the central part of the sole.

The objective of the next phase of the trim is to transfer part of the load of an overburdened lateral hind claw to the medial claw. The medial claw then carries an appropriate share of the load. Therefore, the medial claw must be left high and stable enough to share the role as a supporting structure.

In order to stabilize the loaded claw and allow for optimal distribution of the mechanical forces inside the claw, the bearing surface of both claws must be positioned at a right angle to the metatarsus/metacarpus.

The final stage of the trim is to 'finish' the sole. Slightly different technique might be used depending on the management system:

- (a) On soft surfaces the sole must be trimmed to a concave slope from abaxial wall to the axial surface.
- (b) On a hard surface (concrete) the bearing surface of the lateral hind claw (i.e., wall and about 1.5cm of the sole) must be flat and at a right angle to the metatarsus/metacarpus. This ensures stability under load. Concavity of the sole must be created only beneath the axial region of the sole for two reasons:
- To be able to inspect the axial groove, which is the thinnest part of the claw capsule.
  - To prevent foreign material from wedging between the claws. A slightly concave shape of the axial part of the sole has a positive influence on the elastic function of the claw.

Correct trimming will decrease pressure on the sole and direct weight-bearing to the abaxial wall. The claw will gain lateral stability under load.

See Figures 14-13–14-18.

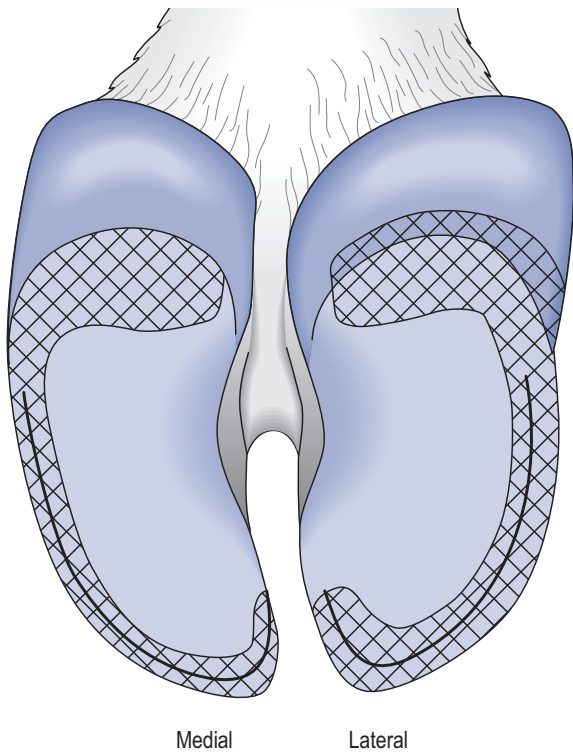


Figure 14-13 The pad marks the junction between the sole and the heel. The lateral claw *may* be larger than the medial claw. The hatched area indicates the optimal bearing surface which includes the wall, white line, a small amount of sole, and the heel pad. The unhatched area is slightly concave.

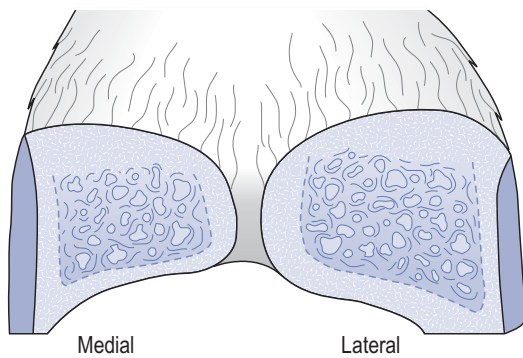


Figure 14-14 This drawing visualizes a transverse section taken through the centre of the normal claw.

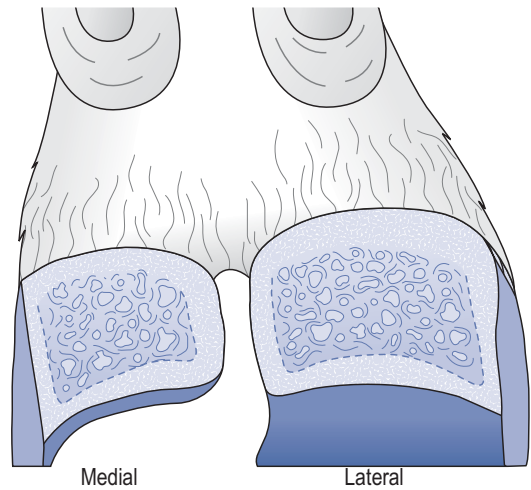
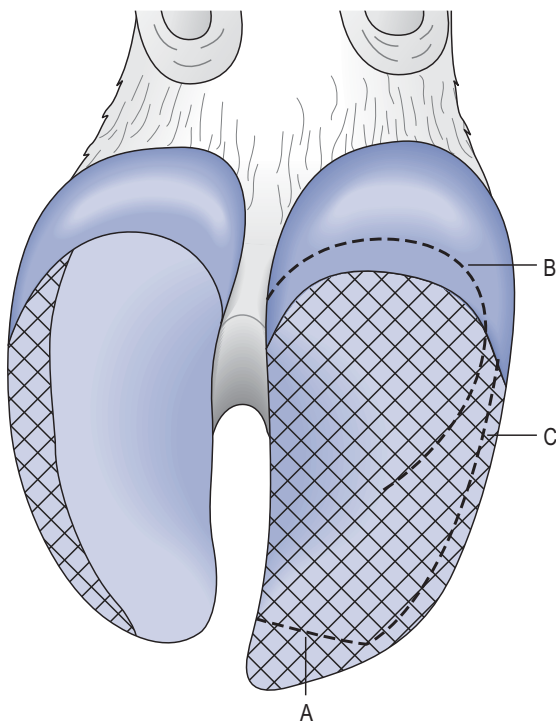


Figure 14-15 The overloaded lateral claw has almost lifted the medial claw from the ground and the upper limb is no longer vertical to the ground.



Figure 14-16 This picture is typical of many that would be presented by cows in free stalls to the claw trimmer. The surface of the sole is flat and obviously wider than normal. In this case sole hemorrhage is visible as a sure sign of overloading. This type of overgrowth can be referred to as 'disproportionate overgrowth.'



**Figure 14-17** The hatched area illustrates the dramatic redistribution of weight-bearing compared with that seen in Figure 14-13. The cut at A shows the point and direction of the first cut with the pincers to shorten the claw. The cut at B slices off the bottom of the heel to the level of the ipsilateral claw. Line C does *not* represent a cut but indicates the position of the wall after the heel/claw length ratio has been restored.



**Figure 14-18** The lateral claw has been reduced to the level of the medial claw. The blood staining visible in the horn of the lateral claw is a clear indication that the claw has been overloaded. (Courtesy of A González Sagüés)

### Recommendations for the Frequency of Claw Trimming

Unless a herd has a major lameness problem it is recommended that the feet of the cows should be trimmed twice each year. There appears to be an advantage to having one trim scheduled for the late fall.

Much woe has been caused by trimming heifers before they calve for the first time if they are also exposed to concrete for the first time. It is best *never* to trim heifers before they calve unless they are lame or the claws are seriously overgrown (at least 10–12cm at the toe).

The need for regular trimming varies between individual animals and is influenced by the rate of horn wear and/or a high plane of nutrition. During routine trimming, lesions such as white line disease and sole ulcer are detected before they cause lameness. Early treatment of such lesions prevents a great deal of later suffering. If these same lesions are not detected and controlled, inflammatory processes accompanying them will stimulate the growth of horn. Follow-up trimming sessions are then highly advisable.

Tethered cows suffer from disproportionate overgrowth, particularly in the front claws – which become extremely hard. Power-assisted pincers are sometimes needed to cut such claws. A very hard claw that has been trimmed to expose soft vulnerable horn beneath tends to disintegrate within 25 days if the cows are turned into a very wet environment.

See Figures 14-19–14-27.



**Figure 14-19** A hind foot before trimming. The claw on the right is the lateral digit. It is only slightly overburdened, a little longer than the medial claw. The outline of the bearing surface is greater and the heel is a little larger. (Courtesy of A González Sagüés)



**Figure 14-21** Next, a very thin slice of irregular horn is removed from the medial claw. The operator is right handed and draws the blade of the knife towards him. He gains leverage on the handle with his thumb. (Courtesy of A González Sagüés)



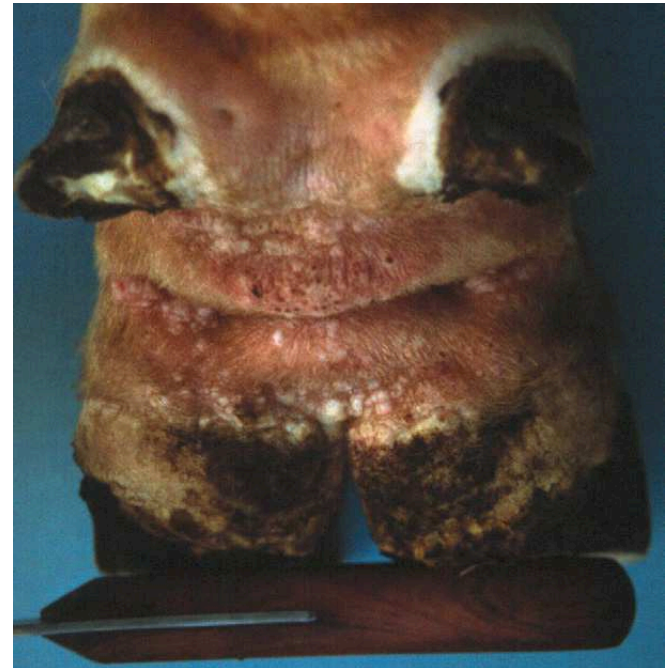
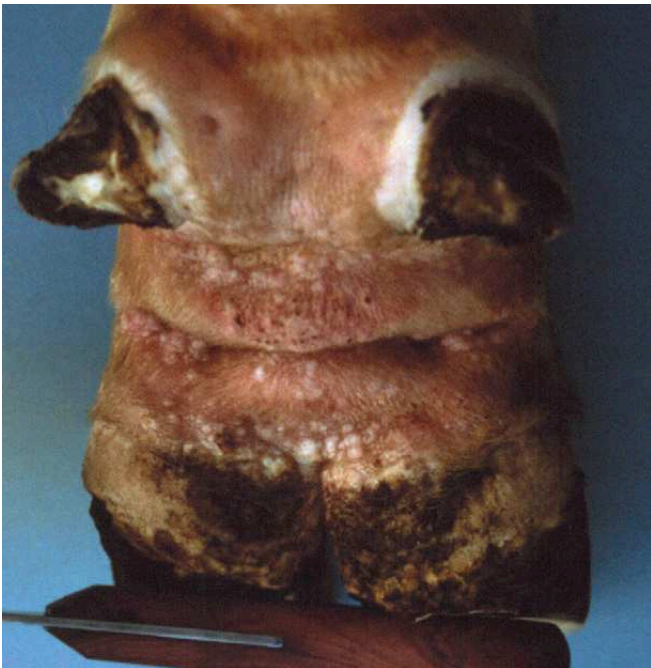
**Figure 14-20** The first step is to reduce the length of the claw by cutting off the apex with pincers. (Courtesy of A González Sagüés)



**Figure 14-22** The blade of the knife is directed to cut into the heel at a level corresponding to the height of the medial heel. Note that the operator is stroking the knife away from him and is using his left hand to provide supplementary force. The cow's foot is resting on the operator's knee in order to stabilize the claw. (Courtesy of A González Sagüés)



Figure 14-23 The soles of the two claws are now exactly on the same plane. (Courtesy of A González Sagüés)



Figures 14-24 & 14-25 Before trimming, the right heel in Figure 14-24 is deeper than the companion heel. Figure 14-25 shows the same claws after they have been trimmed. The bearing surface of the two claws is now level and lateral stability has been restored. (Courtesy of A González Sagüés)



**Figure 14-26** The final touch to the trimming procedure is to hollow out the area around the axial groove. Care must be taken *not* to remove the axial aspect of the newly created pad unless there is excessive erosion in the area. (Courtesy of A González Sagüés)



**Figure 14-27** The completed trim. The slight convexity is more obvious in the lateral claw. Note the substantial flat area at the toe. (Courtesy of A González Sagüés)

## The Diseased Claw

### GLOSSARY

**Horn Defect:** This is any variation in color, consistency, or integrity of the horn tissue which is caused by a disease or injury.

### KEY CONCEPTS

- Therapeutic trimming has been developed as the logical progression of functional trimming.
- Surgical interventions on structures inside the claw capsule must be referred to a veterinarian and be performed using correct surgical techniques (see Chapter 17).

Overload causes an inflammatory reaction comparable with that associated with a laminitis-like episode. Inflammation of soft tissues is accompanied by swelling which, when confined in the rigid claw capsule, will cause considerable pain. If the pressure inside the capsule cannot be relieved, there will be a major risk of irreversible tissue damage. Trimming an overloaded sole not only removes the cause of the inflammation but will also make the sole flexible. This will provide temporary relief until the inflammation has subsided. Unloading a claw having defects is always the first step in treatment.

If both of the claws are long it is not difficult to leave the sound claw high. The objective is to make the sound claw carry the load while the diseased one heals. However, even if an important height difference can be created

with simple trimming, the toe of the affected claw will almost always touch the ground. This contact implies load, and in the case of the outer hind claw, which is invariably longer than the medial, some load-bearing and pressure transference is inevitable. When this is obviously the case the use of a lift is indicated. Load removal is so important that, in order to remove horn by the required amount, the sole of a diseased claw may have to be thinned so much that it flexes on digital pressure.

### Open and Closed Horn Defects

Therapeutic trimming has to be adapted according to the kind of lesion which has to be treated:

- A *closed horn defect* is one that is visible in the horn but the corium beneath is unexposed. In these cases the horn covering may be very fragile and it may only be a matter of time before it becomes 'open.' Closed defects usually resolve if they are relieved from load. Healthy living tissues which are protected by even the thinnest layer of horn should not be exposed. In these cases a 'lift' may allow sufficient rest for the lesion to be resolved.
- An *open horn defect* can be recognized or suspected if the lesion is sensitive to pressure. In these cases, the integrity of the dermal/epithelium interface has been lost from the centre of the lesion. If allowed to do so the living epidermal tissue will invade the denuded areas from the periphery of the lesion. This process will not commence so long as the margin of the lesion is subjected to pressure. Loose horn must be carefully removed and then the horn at the periphery of the lesion must be thinned out carefully to expose healthy living tissues.

Frequently, ridges of horn surround open lesions. The texture and degree of softness of these ridges must be evaluated by careful digital pressure. It is a delicate operation – time and care should be dedicated to it. Relief from pressure will take place if the sound claw lifts the damaged claw from load. If this does not happen a lift should be applied. Bandaging an open lesion is counterproductive as it will apply pressure to the lesion.

### The Effect of other Disease Processes

As overloading of a claw increases to involve the entire sole of a lateral hind claw, invariably weight-bearing will start to occur beneath the flexor process of the

pedal bone. This will cause compression of the soft tissues between an overburdened sole and bone, initiating the first stages of the formation of a sole ulcer.

Infectious diseases affecting the interdigital skin (digital dermatitis and interdigital dermatitis) can have a strong stimulating effect on horn production. Digital dermatitis in the interdigital skin is very commonly associated with strong overgrowth resulting in asymmetry between a right and a left foot in young animals.

The effect of subclinical laminitis varies with the age of the animal and the length of time that the disorder has been present. It is not uncommon to see overgrown front claws in heifers affected by subclinical laminitis housed on soft floors.

## TOPICAL PREVENTIVE MEASURES FOR FOOT CARE

### Foot Baths

#### KEY CONCEPTS

- Cleansing the digits by running the animals through a clear bath water prior to entering a medicated bath not only reduces the bacterial burden on the skin but extends the life of the medication and reduces the negative effects of slurry.
- Manure carried into a medicated foot bath rapidly reduces the effectiveness of most chemical agents.
- If cows are seen drinking from a clean medicated foot bath, adding some manure corrects the problem.
- Foot bathing is most effective when used in conjunction with routine claw trimming.
- Foot baths should contain not less than 250 litres of fluid.
- Medication in a foot bath should be changed after every 200–250 cow passages.
- Water in a foot bath should not be too cold, lukewarm water is recommended. Heating foot baths during wintertime should be considered as a viable option.



### Design

Permanent foot baths are costly to install and often problematic to locate. Portable equipment, usually fabricated from fibreglass, is now available. Only 6.4% of herds with fewer than 100 cows use footbaths in the USA whereas 59% of herds with more than 200 cows employ the technique.

Foot baths must never be located en route to a milking parlor for fear that chemicals used may contaminate milk or adversely affect the milking personnel. It is also useful to provide a collecting area after the bath which will permit excess medication to drain from the feet rather than on to the bedding. A medicated foot bath should be provided with shelter from the rain.

The dimensions should not be less than 10 feet (3.5m) in length and 3 feet (1.0m) wide. The walls of the trough should be sloped inwards to reduce the amount of fluid required. It should be possible for the fluid to reach a height of 5–6 inches (10–12cm). A drain must be installed.

A minimal solution foot bath reduces the amount of expensive medication required in a bath. This device has a soft foam base lying beneath a waterproof membrane. When a cow steps into the bath the fluid moves to bathe her feet. The bath needs only 10–15 litres of fluid compared with 250 litres in a traditional foot bath. Fluid is used at the rate of about 4 litres for every 25 cows.

See Figures 14-28–14-33.



Figure 14-28 & 14-29 This foot bath is of very minimal design. Ideally the wash trough should be located 3–10 meters ahead of the medication bath to permit drainage and allow the cow to defecate. (Courtesy of A González Sagüés)



Figure 14-30 A minimal fluid foot bath is a durable hard plastic tray with a strong pliable liner. Sponge rubber is sandwiched between the two layers. The bath is partially filled with fluid. The cow's foot depresses the lining and fluid swirls around the digits. (Courtesy of M Stable)





**Figure 14-31** This foot bath is located in the open and is not sufficiently long to provide good service. (Courtesy of C Bergsten)



**Figure 14-32** This is a large dimension 'stand in' foot bath. It can be constructed on a frame made of 2ft × 6ft boards and lined with waterproof canvas. These are useful for holding animals for prolonged treatment. (Courtesy of C Bergsten)



**Figure 14-33** The hoof mat is a sponge rubber filled mattress constructed of stout plastic. The upper surface of the mattress is perforated with small holes. The device is soaked in medication. As a cow walks on the mat fluid squirts up out of the holes and sprays the digital area.

### **Solutions Commonly Used In Routine Foot Bathing**

#### **KEY CONCEPTS**

- If possible avoid using antibiotics, heavy metals, or other environmentally hazardous substances in a foot bath.
- Individual treatment (antibiotic spray) should be the first line of treatment for controlling digital dermatitis. However, supplementary foot bathing is strongly recommended.
- Foot baths have a negative effect on the healing of open defects and on complications following foot rot.

#### **Introduction**

The use of a foot bath in conjunction with functional claw trimming is recommended. There is some evidence that trimming opens the tubules and thereby increases the permeability of medication into the horn. Significant exposure to slurry increases the penetration of medications by two or three times. Under normal circumstances a cow walking through a foot bath will only be exposed to medication for about 30 seconds

#### **Formalin**

Formalin in a concentration of 5% is considered to be effective if the ambient temperature is more than 12°C. However, the effectiveness of the product reduces by about 50% in three days of average use. Formalin foot baths are effective in reducing the incidence of interdigital dermatitis, foot rot, and digital dermatitis. Formalin is the least expensive agent that is effective in the treatment of claw infections.

For routine use the optimal number of passages through a formalin footbath should be limited to about ten per month. Continuous use of the product at full strength will cause blistering of the skin around the coronary band and cause the animal discomfort. Probably the most effective regimen is to use formalin for a few days every few weeks.

Reports concerning the use of formalin for the control and treatment of digital dermatitis are extremely contradictory. In Italy formalin is the only active principle which has demonstrated a true effectiveness against digital dermatitis. The recommended protocol is for six consecutive passages at 12-hour intervals on alternate weeks. Other clinicians use formalin footbaths alternatively with antibiotics. Formalin foot baths will reduce the load of bacteria that may predispose to digital dermatitis.

Formalin is reportedly not injurious to the environment but its use has been regulated in some countries. There are reports of milk taint when this product is used. If formalin is used, some benefit accrues from the resulting hardening of the horn of the claw – however, such horn is less plastic.

### Copper Sulfate

A 5% solution of copper sulfate is effective to some extent in controlling interdigital dermatitis but it rapidly rendered ineffective in the presence of organic material. Copper sulfate penetrates the horn tubules to a greater extent than does formalin. There is concern that increases in soil levels resulting from continued application of copper-laden manure could have negative effects on the environment.

### Zinc Sulfate

A solution of up to 20% zinc sulfate has been used.

### Antibiotics

The use of antibiotics in foot baths is not permitted in some countries. There is concern that microbial antibiotic resistance will occur after prolonged use of such medication in footbaths. To avoid this possibility producers are recommended to change the type of antibiotic every 6 months. Since digital dermatitis has become a major problem, various antibiotic solutions have been used (oxytetracycline or tetracycline-HCL, < 6g/L; lincomycin, 1–4g/L). The antimicrobial activity and concentration of these products reduce significantly after a herd uses the bath possibly due to absorption in faeces and soil particles. For special cases a 'stand in' foot bath should be considered (Fig. 14-32). The parenteral use of antibiotics has the disadvantage that withdrawal times have to be increased.

### Other Solutions

No specific product can be endorsed in this book. Scientific trials have been few in number and while the results have been very encouraging, judgement must be reserved at this time. The following products are among those on the market:

- Double Action® (DeLaval)
- Pedline (CID lines Belgium)
- Victory (Westfalia-Surge, Inc).

### Foam

One type of foam available on the market is Kovex™. It is claimed that as the cow walks through the foam prior to being milked the claw is exposed to the medication for 5–10 minutes. However, the cost of installing the equipment need can be high (£1,500) and the medication costs about £1.00/cow/month.

See Figure 14-34.



**Figure 14-34** Foam is claimed to have good penetration into the recesses of the digit while at the same time being effective in controlling most organisms found on the foot. (Courtesy of C Bergsten)

## Topical Dressings and Wraps

### Wraps

Wrapping claws affected with digital dermatitis is the most effective method of treating serious cases of the disease. One treatment is usually very effective although several treatments may be needed for complete resolution. The lesion should be thoroughly cleansed before applying a wrap. A stiff brush may be needed to remove some of the debris from extremely 'hairy' lesions.

A wrap in its simplest form is a bandage soaked in an antibiotic solution or other medication which is applied over a lesion. Alternatively, a dry powder, usually an antibiotic (possibly combined with salicylic acid), is applied directly to a lesion, covered with gauze (or the least expensive feminine hygiene pad) and bandaged lightly in place. A waterproof covering should also be applied. The dressing may also be kept in place by means of a 'bovine bootie' (Fig. 14-35; Mountain Meadows, 680 South 300 East, Providence Utah, 84332 USA).

Although many cows' feet may have to be wrapped, foot bathing and/or spraying should also be continued simultaneously with the remainder of the herd. Using formalin bathing and wrappings on the same cow at the same time can prove dangerous. Each time the cow walks

through the bath the wrap is soaked in the formalin solution – extensive skin mummification and sloughing can occur.

Non-antibiotic products, such as the paste Protexin Hoof Care, are available commercially.

### Sprays

Antibiotic sprays are only effective if the lesions are first cleansed with a jet of clean water. The lesion must be dried before a dressing is applied otherwise the effectiveness of the medication will be diluted. Antibiotics are usually dissolved in deionized or distilled water. Common concentrations are 25g/L Terramycin-343, or 8g/L Lincomix. It is recommended that affected feet should be sprayed once per day for 10–14 days. Spraying should be avoided in the milking parlor during milking.

See Figures 14-36–14-38.



Figure 14-35 The 'bootie' is an inexpensive device which holds a dressing in place, is waterproof and reusable.



Figure 14-36 Jets of water available in the milking parlor are an ideal method for preparing dirty feet to receive medication. (Courtesy of C Bergsten)



Figure 14-37 The cleansed foot can then be sprayed with medication discharged from a back-pack unit and wand. If the treatment is administered in a milking parlor it should not be done when the cows are being milked. (Courtesy of C Bergsten)



Figure 14-38 Aerosols also provide an accurate means for delivering medication, in this case tetracycline, to a treated lesion. (Courtesy of C Bergsten)

## Restraint

### Chemical Restraint

Xylazine in low doses has a calming effect on cattle. As the dose is increased various degrees of sedation follow. The drug is administered intravenously at the rate of 0.05–0.15mg/kg and intramuscularly at 0.1–0.33mg/kg.

### Physical Restraint

A strong man can lift the hind foot of a quiet dairy cow. However, manual lifting of the foot is only worth the

effort to confirm a simple lesion such as that associated with foot rot. In the past the use of a pole inserted in front of the hock and lifted by two men has been used. With this technique the cow invariably struggles and is consequently stressed.

### Mechanical Restraint Devices

#### Use of Ropes

See Figures 14-39–14-44.



**Figure 14-39** Never tie a rope around the fetlock and pull the limb out behind the animal. The animal inevitably struggles violently and frequently either sinks onto its chest or falls. If the head is restrained by a chain around the neck it may choke to death.



**Figure 14-41** The long end of the rope should be passed up over a beam or other convenient structure above the cow. The rope is then passed down and under the hock. The free end is used as a pulley when lifting the limb. It is very important that the rope should slope forward and pass over the hip. When lifting the limb it should be done so in a single 'snatch and lift.' If the operator is strong enough the hock should be lifted almost to the level of the hip. As the knot tightens around the hock the cow's movements are effectively restricted. Pulling the hip into maximum flexion gives the cow an optimal feeling of security from falling. If the cow is secured in a tie stall the head gate or neck chain *must* be secured with string. On the rare occasions when a cow falls it is easier to release her by cutting a rope than finding a metal cutter.



**Figure 14-40** To elevate a hindlimb with a rope, a quick release slip knot should be secured around the Achilles tendon.



**Figure 14-42** This is a picture of portable Dutch device which is of use in tie stalls. The device suspends the limb from a cantilever which is hooked onto the existing pipe framing. In this case the limb is being pulled too far back, which will usually cause animals to struggle. (Courtesy of Anon)



**Figure 14-44** This is an example of how not to lift a hindlimb, The limb is pulled too far to the rear. This could have been easily corrected by tying a wooden post across the structure at a point located further forward. (Courtesy of Anon)



**Figure 14-43** A 'hoofnack' is a fully portable device that clamps on to horizontal pipes. A folding 'gallows' is positioned over the rump of the cow and the limb is cranked up with a ratchet mechanism.

## Equipment Used In Claw Trimming

### *The Crush (Chute)*

The Dutch model crush is of simple and light design and is a good example of the most effective type of equipment used in Europe. The standard size crush, suitable for an adult cow, is constructed of stainless steel with an aluminium slip resistant floor. It can be easily carried around on a small trailer pulled by a car. The crush is provided with panic release hooks (the spinnaker spring catch used on sailing boats) which allow for instant

release of the thoracic belt. The handles driving the winch will not fly out of control when the legs of the cows are lowered. The stainless steel construction is extremely durable and has no need for special maintenance, requiring only periodic lubrication of the shafts and winches, checking the condition of the ropes and cleaning after use.

See Figures 14-45–14-55.



Figure 14-45 This is a mobile device pulled behind the veterinarian's vehicle. The cow walks into the very simple chute and a rope is looped around her hock and fixed to a pulley bar. The operator, in this case the late Toussaint-Raven, pushes down on the other end of the pulley bar and the limb is elevated very swiftly and to a very high level.



Figure 14-46 In Europe the most common chutes are simple in construction and easily portable. (Courtesy of WOPA)



Figure 14-47 This is a portable chute configured for claw trimming. (Courtesy of WOPA)



Figure 14-48 This very simple frame can be fabricated locally to provide a relatively inexpensive crush. (Courtesy of A Brizzi)



**Figure 14-49** The simple chute shown in Figure 14-48 permits the hindlimb to be elevated while at the same time the operator is able to elevate the front limb. A simple belly strap prevents the animal from sinking onto its chest. Note how the operator stands well back. Cows can lunge forward with their knee, inflicting a painful blow. (Courtesy of A Brizzi)



**Figure 14-50** In Italy a practice specializing in claw care can deliver several chutes and a crew of claw trimmers supervised by a veterinarian. This is part of a complete animal health service. (Courtesy of A Brizzi)



**Figure 14-51** In the same Italian practice illustrated in the last picture three claw trimmers and the supervising veterinarian rapidly deliver the trimming service. This minimizes the stress on the cow. Note that each trimmer has teat liners from milking machines stuck in the tops of his boots. These act as convenient sheaths for left and right handed knives. Traditionally the pincers are slipped into the tie string of the apron. (Courtesy of A Brizzi)



**Figure 14-55** In North America the tipping table is still popular. It is probably more stressful than necessary for dairy cows than a walk-in chute. It remains the system of choice for beef cattle. (Courtesy of Anon)



**Figures 14-52, 14-53 & 14-54** A highly mobile chute manufactured in Japan has been designed specifically for modern loose housing systems. The cow is fixed in the head gate, the device is rolled up and around her and the limbs elevated by a ratchet and pulley system. (Courtesy of K Yoshino)

### Claw Trimming Equipment Introduction

It is essential that knives, pincers and grinding discs should scrubbed clean and disinfected after use. This is particularly important when digital dermatitis is present on the farm.

### Knives

There is an almost infinite variety in the quality, shape, and size of knives. However, only a limited number of manufacturers produce knives that are really very sharp and can maintain an edge. Knives need to be razor sharp, otherwise the operator will have to apply too much physical effort and this means that cutting will be less precise and may even become dangerous for man and animal.

Knife sharpening is normally carried out with a bench grinder with a 120-grit disk. The grinding disk must rotate away from the operator. Care must be taken not to overheat the blade as this will ruin the temper of the metal. Once the preliminary sharpening is complete a fine edge can be obtained by using a suitable abrasive paste on a cloth disc. A newly sharpened knife should be able to trim all four feet of 20–25 cows, provided no stones are embedded in the horn.

For maximum cutting efficiency the convex surface of the knife must remain perfectly flat. The sharpening, therefore, must only be applied to the inner convex side of the blade. The exception is the 'hook,' where the outside border is sharpened. The inside of the hook can also be sharpened with the round chainsaw file.

Sharpening is a dangerous job, so care has to be taken to prevent accidents. Goggles and gloves should be worn – if working on a bench near to a wall the latter should





**Figure 14-56** Swedish knives are perhaps the most popular in use at this time. They are noted for holding a sharp edge for longer than other makes of instrument. (Courtesy of A Brizzi)



**Figure 14-57** This is an older model Swedish knife. The edge of the narrower blade show signs of considerable wear. Note that Figures 14-56 and 14-57 are a matched pair of left- and right-handed knives. (Courtesy of A Brizzi)

be conveniently padded in order to prevent a knife from rebounding if the hook catches in the grinding wheel.

See Figures 14-56 and 14-57.

### Pincers

The pincers are used to cut the bearing margin of the wall and reduce the length of the claws. There are several different models to choose from, each having different features that should be taken into consideration. One design may have a favorable lever action but have a small jaw opening. Other models are fabricated from electrically hardened softer steel. This type can be lightly sharpened with a file when required. However, care must be taken to ensure the cutting edges of the jaws do not close one against the other.

Equine farrier's pincers are made of hardened carbon steel which must be sharpened by the manufacturer.

After cleaning, the spindle should be lubricated with oil which also reduces the risk of rusting.

See Figure 14-58.



**Figure 14-58** Simple pincers. (Courtesy of A Brizzi)

### Hydraulic Pincers

The hydraulic pincer (Fig. 14-59) was been developed in Italy to cut the extremely hard front claws of cows housed year round in tie-stalls. The outfit consists of a hydraulic pump, a 1HP electric motor, two rubber hoses, the cutting blades, and fitted actuator lever. The actuating lever can stop, slow down, or instantly reverse the cutting action. The device is heavy enough to discourage single hand use.

The cutting action of the jaws can deliver a pressure of about 500kg which will cut through the hardest horn. It is difficult to remove less than 0.5cm of material with hydraulic pincers. Smaller thickness should be removed by an angle grinder. Maintenance of a hydraulic pincer is straightforward – cleaning and checking the oil level in the reservoir is all that is needed. Sharpening of the jaw blades is best left to professionals.

### Angle Grinder

Angle grinders (Fig. 14-60) consuming about 300watts and driving a 135-mm (6-inch) cutting or grinding disk made their appearance in claw trimming almost 20 years ago.

### Cutting Disks

Cutting disks (Fig. 14-61) are made of high resistance steel carrying a variable number of hard inserts which actually chip the horn. Less expensive disks are fabricated from pressed steel with cutting edges punched through the surface. These discs are light and are only of limited use. Cutting disks are heavy (up to 200g) and generate considerable inertia when driven at 12,000 rpm. This means that considerable force has to be used by the operator to control and change the direction of the cutting action. If the disk has aggressive cutters there is considerable risk of over-trimming.



Figure 14-59 Hydraulic powered pincers will deliver enough cutting force to remove the hardest horn. (Courtesy of A Brizzi)



Figure 14-60 A small domestic angle grinder is suitable for use in claw trimming. (Courtesy of A Brizzi)

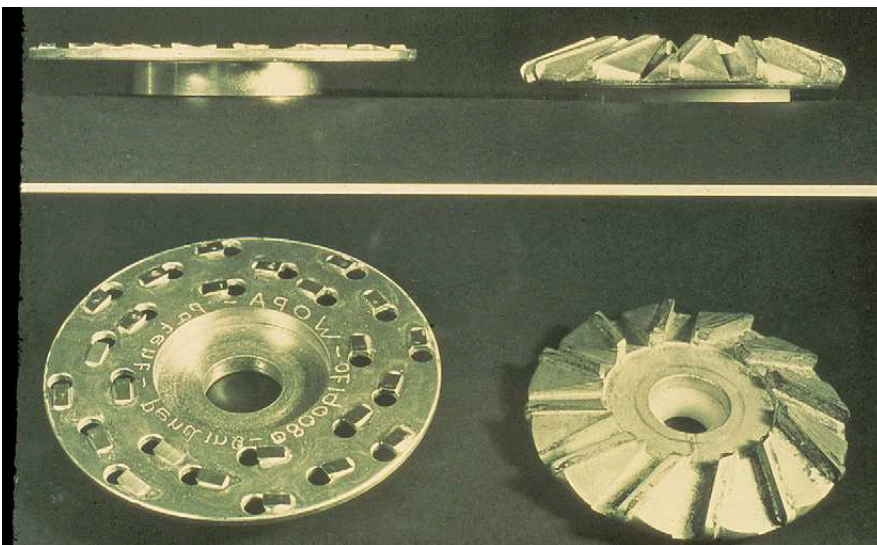


Figure 14-61 Metal cutting disks are available in various designs.

Vibration of the disk is directly proportional to its size and weight. Excessive vibration can be very tiring. Some disks are dynamically balanced or are fitted with an elastic washer which supposedly dampens vibration.

### Grinding Disks

Grinding disks are made either of steel or fiber coated (Fig. 14-62) with carbide particles of different (grit) sizes. The coating can be flat or have radial spiral grooves pressed into it. The size of the abrasive particles determines the amount of horn that will be removed and the amount of heat that will be generated.

Steel-backed grinding disks are heavy and have the same problems seen with cutting disks – difficulty in direction of the action and vibrations. On the other hand they are durable and can be washed and dried when they become clogged.

Fiber-backed grinding disks are much cheaper but also weaker and should always be used with a synthetic backing disk (matched to the operational rpm of the tool). Being light they are easier to manipulate and are almost vibration free. The operational life of a fiber-backed disk is 300–400 feet. This type of disk cannot be washed when clogged but only brushed or cleaned with compressed air.

When grinding, fine horn dust is produced – inhalation of this dust should be prevented by wearing a suitable mask. The risk of sharp particles being thrown off by centrifugal force indicates that goggles and gloves should always be worn when grinding.



Figure 14-62 Fiber-backed grinding disks must also be supported by a synthetic backing disk. (Courtesy of A Brizzi)

## Bandaging

### KEY CONCEPT

- If at all possible avoid applying a bandage between the claws as this tends to open up the interdigital skin and retard healing. A square of gauze can be inserted between the claws to keep medication in place.

Severe wounds of the feet need to be protected once they have been thoroughly cleansed and a bacteriostatic agent applied. Bandages can perform this function only if a waterproof outer covering is applied. If bandages are exposed to the environment they act as a wick, drawing contaminants into and infecting the wound. A 4-inch (10-cm) linen bandage should first be stabilized with winding around the pastern. Further windings should then be carried, figure-of-eight fashion, around the entire foot – this holds the two claws together. It is useful to cover the completed bandage with a plastic freezer bag which should be held in place and further protected by means of adhesive tape.

## Lifts and Shoos

### GLOSSARY

**Lift:** This is any device that is fixed to the sole of a sound claw for the purpose of elevating a diseased claw from contact with the ground. The objective is to allow time for the diseased tissue to rest and repair.

**Shoof:** This is the proprietary name for a slipper constructed of almost indestructible plastic (Figs 14-63 and 14-64). Difference in color indicates the size of the device. It is expensive and unless correctly applied it can be kicked off by the cow.



Figure 14-63 A Shoof is a cow shoe that laces onto the whole foot. The size of the Shoof is color coded. (Courtesy of Anon)



Figure 14-64 There are three different configurations for the tread of the sole. The whole sole can have a tread or either claw may have a tread. (Courtesy of Anon)

The simplest and least expensive form of lift is a wooden block. Both faces of commercially available blocks are incised with deep grooves. One side provides a good surface to which adhesive can stick and the other provides stability on the ground surface. Before applying a block the sole of the claw should be prepared by being lightly trimmed and cutting grooves to expose clean dry horn and increase the surface area to which the adhesive will stick. If methyl methacrylate is used as the adhesive time must be allowed for it to cure. If the block slips forward it will cause the animal to trip and stumble. Care must also be taken that the rear edge of the block does not press on the sole as this will cause a localized inflammatory reaction.

A rubberized block is available which is attached with pony nails but their use is not recommended as they tend to twist across the foot after they have been in use for even a short period.

See Figures 14-65–14-70.



**Figure 14-65** A simple block of hard wood is cut into the shape of the sole of a cow's foot. Each side is deeply scored and, therefore, is reversible. One side will contact the ground and the other will be fixed to the sole with adhesive. (Courtesy of A Brizzi)



**Figures 14-66** Different designs of slippers have been manufactured. Each has a stout 'lift' to which an upper has been molded.



**Figure 14-67** The inner part of the shoe is a convenient place in which to mix the components of the adhesive. (Courtesy of J Malmo)



**Figure 14-68** The shoe is pressed firmly onto the foot. Curing of the adhesive can be accelerated by means of a hair dryer. (Courtesy of J Malmo)



**Figure 14-69** The slipper lifts the diseased claw from bearing weight. The 'tread' on the bottom of the slipper helps to provide stability. (Courtesy of J Malmo)



**Figure 14-70** Some slippers fail to adhere properly. They should be removed and re-applied, otherwise damage will be caused by abnormal pressures. (Courtesy of J Malmo)

## BIBLIOGRAPHY

- Blowey R W 1998 Local application of lincomycin for treatment of digital dermatitis. Proceedings of the XXth International Symposium on Disorders of the Ruminant Digit, Lucerne, p 276–277
- Blowey R W 1993 Cattle lameness and hoofcare. Farming Press Books and Videos, Ipswich
- Blowey R W 2004 Use of a novel foot foam in the control of digital dermatitis. Proceedings of the XIIIth International Symposium on Disorders Ruminant Digit, Maribor, p 30–32
- Britt J S, Carson M C, Bredow von J D et al 1999 Antibiotic residues in milk samples obtained from cows after treatment for papillomatous digital dermatitis. *Journal of the American Veterinary Medical Association* 215:833–836
- Davies R C 1982 Effects of regular formalin footbaths on the incidence of foot lameness in dairy cattle. *Veterinary Record* 111:394
- Gradle C D, Felling J, Dee A O 2002 Treatment of digital dermatitis lesions in dairy cows with a novel non-antibiotic formulation in a foot bath. Proceedings of the XIIth International Symposium on Disorders Ruminant Digit, Orlando, p 363–367
- Holzhauser M, Sampion O C, Counotte G H M 2004 Measuring the initial concentration of formalin in walk-through footbaths in dairy herds. Proceedings of the XIIIth International Symposium on Disorders Ruminant Digit, Maribor, p 21–24
- Hoblett K 2002 Foot baths: separating truth from fiction and clinical impressions. Proceedings of the XIIth International Symposium on Disorders Ruminant Digit, Orlando, p 35–38
- Janowicz P, Bathina H, Durkin J 2002 Foot bathing in the hoof health management. Proceedings of the XIIIth International Symposium on Disorders Ruminant Digit, Maribor, p 28–29
- Kempson S A, Langridge A, Jones J A 1998 Slurry, formalin and copper sulphate: The effect on the claw horn. Proceedings of the Xth International. Symposium on Disorders of the Ruminant Digit, Lucerne, p 216–217
- Laven R A, Hunt H 2002 The efficacy of non-antibiotic foot baths in the control of digital dermatitis in the UK. Proceedings of the XIIth International Symposium on Disorders of the Ruminant Digit, Orlando, p 336–367
- Pijl R 2002 Checkpoint: Documentation of claw-trimming via palmtop to personal computer. Proceedings of the XIIth International Symposium on Disorders of the Ruminant Digit, Orlando, p 431–433
- Stanek C H, Thonhauser M M, Schroder G 1994 Does the claw trimming procedure affect milk yield and milk quality factors. Proceedings VIIIth International Symposium on Disorders of the Ruminant Digit, Banff, p 306
- Toussaint Raven E 1989 Cattle foot care and claw trimming. Farming Press Books and Videos, Ipswich
- Serieys F 1982 Comparison of eight disinfectants for cattle footbaths. Proceedings of the IVth International Symposium on Disorders of the Ruminant Digit, Paris
- Seymour J, Durkin J, Bathina H 2002 Footbathing in the management of digital dermatitis. Proceedings of the XIIth International Symposium on Disorders of the Ruminant Digit, Orlando, p374–376
- Stokka G L, Lechtenberg K, Edwards T et al J 2001 Lameness in feedlot cattle. *Veterinary Clinics of North America*. Anderson 17:189–207
- Shearer J K, Elliott J B 1998 Papillomatous digital dermatitis: Treatment and control strategies. *Compendium of Continuing Veterinary Education Practice* 20:158–173

**198** 14 / Claw Trimming, Foot Baths, Restraint, Bandaging, Lifts, and Shoes

Ward W R 1994 The minimal solution footbath – an aid to treatment of digital dermatitis. Proceedings VIIIth International Symposium on Disorders of the Ruminant Digit, Banff, p 184–185

White E M, Glickman L T, Embree C et al 1981 A randomized trial for evaluation of bandaging sole abscesses in cattle. Journal of the American Veterinary Medical Association 178:178–377

# Infectious Diseases and other Conditions Affecting the Interdigital Space

## FOOT ROT

Foot rot is also known as Interdigital Phlegmon, Foul in the Foot, Lure, and Interdigital Necrobacillosis.

## Historical Comment

What was probably Phlegmona Interdigitale (Foot Rot) was described by De Stefanis in *Il Veterinario* in 1854, by Mazzini in 1884, and by Harms in 1885. Necrobacillosis was described in North America in 1922.

## Introduction

### KEY CONCEPTS

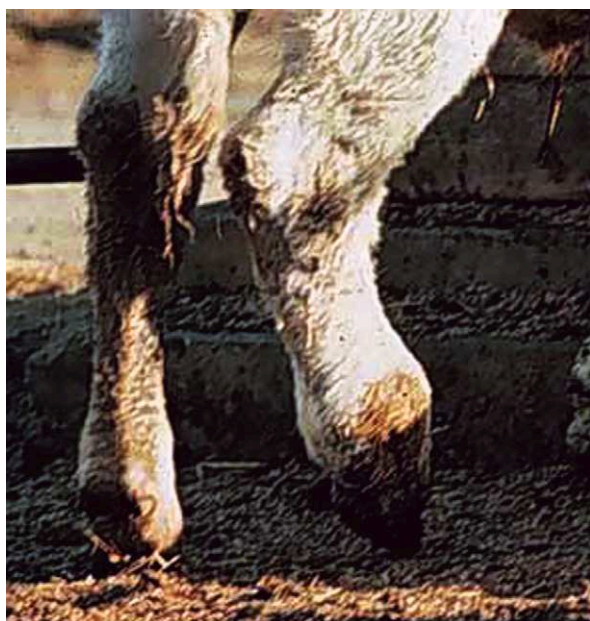
- Foot rot in cattle should not be confused with foot rot in sheep. In sheep the comparable disease is referred to as foot abscess. Foot rot in sheep is caused by *Dichelobacter nodosus*, is etiologically different and cross infection is not believed to occur.
- *Bos indicus* cattle (Brahman and Sahiwal) are significantly more resistant to foot rot than are *Bos taurus* (Australian Illawara Shorthorn).
- Never neglect to lift the leg of a lame cow to confirm the diagnosis.

## Description

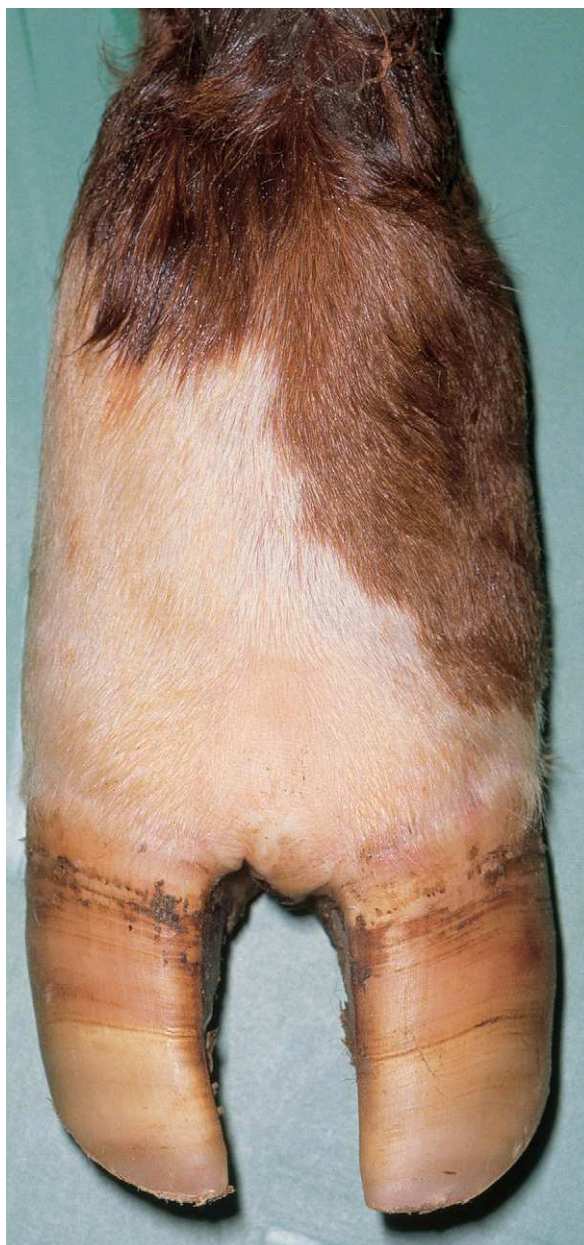
The overall incidence of foot rot is probably less than 5%, but in epidemic outbreaks the incidence of the disease can be as high as 20% of the milking cows in a herd. Foot rot is an extremely painful condition. Pain causes a negative physiological reaction as well as reducing the animal's incentive to seek feed and water. The following clinical signs are routinely present:

- The body temperature rises.
- A very rapid drop in milk yield.
- The reduced milk yield will continue so long as the animal is in pain.
- The feed intake will decline.

The mean yield from a high-production cow affected with foot rot can be as much as 1,285kg (2,827lb) less than that of a healthy cow. This is particularly noticeable if a milking cow has foot rot before she reaches her milking peak and treatment is delayed. In this case, the total yield for the lactation may drop by more than 20%. If the disease occurs toward the end of the lactation or when the cow is dry, the economic loss will be less severe. In countries where antibiotics are available to producers, the cost of medication has to be considered. In countries that require treatment by a veterinary surgeon, the costs will be much higher. An added expense



**Figure 15-1** Foot rot causes lameness that is sudden in onset and becomes progressively more acute over a relatively short period of time (6–12 hours). (Courtesy of Anon)



**Figure 15-2** The whole foot, up to the fetlock, will be swollen; the skin will be pink and tender to the touch. (Courtesy of D Miskimins)

is loss of milk sales resulting from the withdrawal time required for some medications.

There will be temporary reproductive problems such as delayed heat and/or poor conception.

A very acute form of foot rot has been described in Europe. 'Blind foul' is a form of the disease causing





**Figure 15-3** The swelling will cause the two digits to separate, and the cleft between the claws will appear to be larger than normal. (Courtesy of D Miskimins)



**Figure 15-4** The skin between the claws becomes necrotic and sloughs. The discharge has a typical foul odor. (Courtesy of Anon)

considerable swelling but no interdigital lesion during the early stages. It is believed that this condition may be caused by blood-borne organisms. 'Super foul' is the form of the disease that is extremely aggressive and fails to respond to treatment. Radiography is not useful in most instances, but is essential in cases failing to respond to treatment, and when either septic pedal arthritis or a retroarticular abscess are suspected.



**Figure 15-5** The striking characteristic of the retroarticular abscess is that there is swelling around only one digit. With foot rot, both digits and pastern are swollen.

### **Differential Diagnosis**

#### **A. Retroarticular Abscess**

The condition is very commonly confused with foot rot. These cases are usually presented as, 'a case of foot rot that is resistant to prolonged treatment with one or more antibiotics.' This condition is a complication of white line disease or sole ulcer (see p. 89) for which surgical treatment is necessary.

#### **B. Septic Arthritis of the Distal Interphalangeal Joint**

#### **C. Foot and Mouth Disease**

A cow affected by foot and mouth disease can show signs of lameness for a few hours before other more characteristic signs appear. It should be noted that with foot and mouth disease the milk yield of the entire herd may drop before clinical signs appear.

See Figures 15-1–15-7.



Figure 15-6 When the pedal joint becomes involved the region above the coronary band on the dorso-lateral surface is extremely swollen, pink, and tender.

### Cause

*Fusobacterium necrophorum* has been isolated from over 90% of clinical cases of foot rot in cattle. Strains of *F. necrophorum* are normal inhabitants of the intestine of cattle and is, therefore, shed into the environment but their pathogenicity is uncertain. It can remain dormant in the soil for several months, particularly in the presence of dried feces. The organism contaminates areas where cattle congregate, such as tracks, areas around drinking sources, in gateways, in muddy corrals, or in the slurry of barns and loose houses.

It is believed that most cases of foot rot result from the organisms entering the subcutaneous tissue through interdigital skin. It has been assumed that this occurs as the result of traumatic damage or the action of irritant agents in slurry. Another commonly held opinion is that the skin is made vulnerable by the action of various organisms frequently found on the skin of the digit. Whatever the cause, the protective barrier of skin must



Figure 15-7 The capsule of the joint is very close to the interdigital skin at the dorsal flexure of the interdigital space. When a foot rot lesion breaches the skin at this location, infection enters the joint.

be weakened or damaged before the bacteria can invade the underlying tissue.

A genetic predisposition might be involved; the barrier can be less strong in some animals. Lack of micronutrients (minerals, vitamins) can result in a weaker skin barrier. Disturbances in the local immune system might be involved, as might mechanical injuries, hyper hydration of skin, or simply poor hygiene.

### TECHNICAL COMMENTS

In addition to *F. necrophorum*, *Dichelobacter nodosus* and *Bacteroides melaninogenicus*, other microorganisms such as *Actinomyces pyogenes*, *Spirocheta* spp., *Staphylococcus* spp., *Streptococcus pyogenes*, various fungi, and viruses have been commonly isolated from typical lesions.

There is no consensus of opinion concerning the exact mix of organisms which may or may not be essential to support the activity of *F. necrophorum*.

*F. necrophorum* is a Gram-negative, non-sporing, non-flagellated, non-mobile, very pleomorphic anaerobic

bacteria. The bacteria produce a leucocidin activity which enhances the infective power of *Arcanobacterium pyogenes*. It also has a lipopolysaccharidic endotoxin with a heat stable cell wall component, together with necrotizing capabilities, as well as a component of heat labile cytoplasm with erythematous features.

The following subspecies have been identified:

- 'Biotype A' *E. necrophorum*; subspecies *necrophorum* (found in the gut, probably benign)
- 'Biotype B' *E. necrophorum*, subspecies *funduliformis*
- 'Biotype C' *E. pseudonecrophorum*.

Within each subspecies, the DNA of a number of different genotypes has been identified using gas chromatography. In the future, it is anticipated that polymerase chain reaction (PCR) technology will become more available, making identification of the subspecies easier. Each genotype has specific predilection for certain tissue(s).

Numerous serotypes have been identified. The degree of aggressiveness of the disease probably depends on the virulence of the strain of *E. necrophorum* implicated.

Hypothetically, the organism could be shed into the gut from liver abscesses which are far more prevalent in dairy cows than has been previously recorded. However, it has also been found that *E. necrophorum* is not tolerant to bile. The bacteria are shed into the environment in copious numbers from the open lesions of infected cattle. The majority of reports indicate that foot rot is more prevalent when the environment is moist and warm.

The incubation period in experimentally induced foot rot is about 7 days. If untreated, the lesions reach their maximum intensity about 7 days following the appearance of the first clinical signs.

Foot rot in sheep requires not only a virulent strain of *Dichelobacter (bacteroides) nodosus* to be present, but also requires *Fusobacterium (sphaerophorus) necrophorum* to be present.

## Treatment

Delay in treatment not only increases the loss of milk but also the loss of body condition. This can be particularly severe in beef cattle at pasture when the disease may not be diagnosed until it has reached an advanced stage. Beef cows with calves at foot will experience pain, causing a drop in milk yield, which in turn will affect the daily weight gain of the calf.

If treated, most cases respond very rapidly, usually with very little after-effect. Although immediately after recovery there is a very strong immunity, recurrence occurs occasionally if the animal encounters other strains of the organism. Natural immunity appears to inhibit re-infection by the same strain for at least 6 months. If a new case of foot rot occurs in a cow within 6 months of an original infection the diagnosis should be carefully re-examined.

If foot rot is not treated, the course of the disease will be prolonged and the risk of complications will increase. Nevertheless, in some feedlots in the United States, it has been found that treatment is not cost effective. The rationale for this practice is that sorting beef steers to identify lame animals is far too labor intensive. Feedlot operators find that the steers recover spontaneously after suffering a set-back in weight gain, but that compensatory growth minimizes the economic loss.

Conventional treatment has been, for many years, the intramuscular injection of penicillin G for three consecutive days. However, in recent years, penicillin has been proving less effective and much higher doses than recommended on the product label have to be used. If the dose is increased, so must be the withdrawal times for the milk. If cows fail to respond to treatment with an antibiotic within 48 hours, there are three different reasons that could account for this:

1. The diagnosis may be incorrect.
2. The dosage of the drug used may be inadequate.
3. Antimicrobial resistance may be increasing in the bacteria involved in the pathologic process.

Successful treatment has as much to do with case management and pharmacokinetics in the affected tissue as it does with bacterial susceptibility. Delayed diagnosis and treatment, inadequate cleaning of the lesion, poor treatment schedules, or selection of an inappropriate drug all contribute to a lack of success.

Unresponsive cases should be given a broad-spectrum antibiotic such as long-acting oxytetracycline, Tylosin, or sodium sulfadimidine, trimethoprim sulfate, amoxicillin, ampicillin, cephaloridine, gentamicin, clindamycin, and streptomycin have all been used with satisfactory results. It is best for a producer to discuss the treatment strategy with a veterinarian.

The most effective way to treat the most advanced, unresponsive, and/or acute cases is by intravenous infusion via the digital vein with a suitable antibiotic. This procedure must be undertaken by a veterinarian. A tourniquet is applied above the swollen region and the injection is made into one of the veins. (If the limb is very swollen it is often difficult to find the vein.) The tourniquet can be left in place for 20 minutes. If the tourniquet is applied for a longer period, tissue damage will occur. The tourniquet is released slowly to ensure that the antibiotic does not flood into the body at too rapid a rate.

If the skin of the interdigital space has sloughed, topical treatment is essential. This is particularly important if a secondary lesion appears to be starting in the dorsal region of the interdigital space, at which point the capsule of the pedal bone is very superficial. The wound should first be cleansed with soapy water, then thoroughly dried. A generous amount of a topical dressing such as an antibiotic paste should be applied and held in place with a light pad of gauze. The lesion must then be protected at least for a few days. It is poor practice to wrap a bandage between the claws as this opens the wound and delays healing. However, the claws may be bound together with a bandage. In order to avoid the bandage acting as a wick when immersed in slurry it may be enveloped in a stout freezer bag and protected from wear with duct tape.

If appropriate treatment fails to produce an early resolution, the case should be re-checked for complications or an alternate diagnosis.

## Prevention and Control

### **Foot Baths (see p. 183)**

Some reduction in incidence may be expected if regular foot bathing is practiced. Indirectly the foot bath can reduce the risk for foot rot by reducing interdigital dermatitis. Footbaths using 5% copper sulfate are useful, but this chemical deteriorates rapidly in the presence of the organic material in manure; therefore, a cleansing system (water bath) preceding the chemical bath is advocated. Formalin, used at 2–4%, is useful, but the fumes can be undesirable in the milking parlor.

Newer solutions and foam products are coming on the market which are claimed to be superior to either formalin or copper sulfate, however, the documentation of the effectiveness is poor.

### **Zinc Methionine**

The value of zinc methionine is strongly supported by research findings. Anecdotally, testimony to the effec-

tiveness of the product can be taken from the high percentage of feedlots in the United States using the product. Cattlemen rarely invest in practices which are not cost effective.

### **Ethylenediamine Dihydroiodide (EDDI)**

The use of oral inorganic iodides is prohibited in some countries. Where it has been used commercially, the benefits are considered to be variable.

### **Paraformaldehyde**

Paraformaldehyde is a polymer of formaldehyde but is degraded at a slower rate than the simple chemical, so it persists in the environment for a lengthier period of time. The addition of 25–50lbs (55–110kg) of paraformaldehyde per feedlot pen (40 × 80ft or 12 × 25m) has been shown to temporarily suppress bacterial proliferation and significantly reduced the incidence of foot rot.

### **Immunization and Vaccines**

Natural immunity of heifers could be strengthened by exposing them to dry herd mates in good time before calving. Proprietary vaccines are available but are, at present, questionable as to their cost effectiveness. Two injections are required one month apart, but the immunity that develops only reduces the incidence of the disease slightly and does not eliminate the risk completely. The use of autogenous vaccines (custom vaccines prepared from samples from actual lesions) has proved to be very effective with deer.

Nevertheless, vaccinating bulls semi-annually is strongly recommended. When a bull suffers from foot rot, the fertility of the animal drops immediately and is slow to recover. Bulls will also be at higher risk if transferred between herds that are affected by slightly different strains of the organism.

### **Husbandry**

Once a case has become 'open,' the discharge of the causal organisms into the environment causes contamination of those areas in which the traffic of cattle is heaviest. Therefore, reducing exposure to slurry will be the first consideration. Good drainage around drinking and feeding areas is essential. The isolation of affected cows by moving them to a separate pen or stall (or the use of a protective boot) during the early infectious stages of the disease is strongly recommended. Very early, adequate treatment is essential. When herds are expanding and animals are bought in, special care

must be taken. Older cows may introduce new strains of the organism, while heifers may have no immunity at all.

## INTERDIGITAL DERMATITIS (STABLE FOOT ROT, SLURRY HEEL, SCALD)

### Introduction

#### KEY CONCEPTS

- Interdigital dermatitis (ID) is a mild superficial infection of the skin between the claws.
- In most instances, ID is a benign condition rarely causing lameness and is not associated with a drop in milk yield, loss of body condition, or increase in body temperature.
- ID is strongly related to heel horn erosion as a secondary complication.

This condition has been confused in the literature with foot rot. The clinical signs of the two diseases are, however, distinctly different. ID causes no inflammation nor edema of the digital region as is the case with foot rot. The body temperature does not rise, milk yield does not drop until complications are present, there is no sloughing of necrotic material from between the claws, nor is an animal lame in the early stages.

ID in cattle is caused by *Dichelobacter* (*Bacteroides*) *nodosus*. However, different genotypes of this same organism cause foot rot in sheep. Transmission of the severe disease in sheep to cattle has not been reported.

The importance of ID is the probability that it may play a (yet unproven) role in the evolution of other diseases such as foot rot, digital dermatitis, and heel erosion. *D. nodosus* and *E. necrophorum* have been consistently isolated from many foot lesions. However, other organisms frequently present in the interdigital space could also play a part in the progress of some of these diseases.

### Description

As the condition progresses, the animal shows discomfort by constantly moving from one foot to the other –

this is an obvious sign of irritation or itching. The limbs may be held further back than normal.

True lameness may not occur until a complicating lesion is present. ID is strongly related to heel horn erosion as a secondary complication and this may be the most important complication of the disease. There is a low prevalence of ID in cattle at pasture, but it will increase when animals are confined and housed.

ID is particularly prevalent when the feet of cattle are continuously bathed in slurry. This state of affairs occurs most commonly during cold winter months. By later winter, some animals may be showing discomfort and pain-producing lesions may be observed.

In cases of ID, erosion of the heel horn will reduce the height of the heel. Less frequently, after a prolonged period during which the animal has avoided bearing weight on the heel, the horn beneath the heel will increase in thickness, causing some aberrations of gait.

See Figures 15-8–15-13.



Figure 15-8 The first stage of interdigital dermatitis appears to be a wet dermatitis of the skin between the claws.



Figure 15-9 Exudate produced by the disease oozes to each end of the space between the claws and forms a crusty scab which may be occasionally observed on the dorsal surface of the digits.



Figure 15-11 Gradually the heel lesion becomes more extensive. This looks very much like digital dermatitis with the typical white border zone.



Figure 15-10 As the condition progresses, the heels of the hind feet start to erode and become quite raw. This stage can be painful; the animal shows signs of lameness and the hindlimbs will be held further back than is normal.



Figure 15-12 After a prolonged period during which the animal has avoided bearing weight on the heel, the horn beneath the heel will increase in thickness.



Figure 15-13 Chronic irritation of the skin between the claws of dairy cows is the most common cause of corns (fibroma) developing on one side of the space.

### TECHNICAL COMMENTS

*D. nodosus* is a Gram-negative, non-capsulated, non-sporing, non-mobile (80%), anaerobic bacteria. The genotypes are named from A to I. About 20% of the bacteria have 'fimbriae' or 'pili' on the surface which are 6nm in diameter and 5µm long. The pili are strongly associated with the various serogroups. The bacteria are highly proteolytic and can digest casein, collagen, fibrinogen, gelatin, elastin, and hide powder. Pili are also believed to spread the bacteria within the hoof epidermis after proteases attack. Pili are strongly antigenic and facilitate infection by allowing colonization and further spread into the epidermis of the hoof after proteases attack.

### Differential Diagnosis

Small areas of granulation tissue at either commissure of the interdigital space are suggestive of the resting stage of digital dermatitis but could be confused with early ID. Foot and mouth disease can easily be confused with ID if only digital lesions are present. With both conditions, an affected animal may paddle to and fro on its hindlimbs. If the feet are lifted and examined closely, the differential diagnosis is obvious.

### Treatment

The use of systemic therapy including antibiotics is not warranted. In severe cases, the lesions should be cleaned and dried, after which a topical bacteriostatic agent should be applied, e.g., 50% mixture of sulfamezathine powder and anhydrous copper sulfate. Oxytetracycline sprayed onto a cleansed lesion is also effective. Alternatively, an animal can be confined in a 5% copper sulfate foot bath for one hour, twice daily for three days.

### Prevention

#### Immunization and Vaccines

At the present time, vaccines are not available for cattle.

#### Husbandry

Interdigital dermatitis is most severe in the presence of unhygienic conditions which are likely to occur in most operations during the winter months. Control measures must include reducing the presence of slurry and favour dry underfoot conditions. Regular foot trimming will help to avoid complications by early detection and treatment.

Foot bathing, commencing in late fall and before clinical cases can be identified, is essential in herds known to be infected. Solutions of 3% formalin or 5% copper sulfate are usually effective. However, these chemicals biodegrade slowly; therefore, new products are being presented in the market. Weekly foot bathing may be sufficient in the late fall, but the frequency may have to be increased in late winter.

## DIGITAL DERMATITIS

Digital dermatitis (DD) is also known as Hairy Foot Warts, Strawberry Foot Rot, Mortellaro's Disease, and Raspberry Heel.

### Historical Comment

The infectious form of DD was first reported in Italy in 1974, in Holland in 1986, and in the United Kingdom in 1988. A similar condition was reported in North America in 1992. For some years, the condition was known as 'Mortellaro's Disease.'

### Description

#### KEY CONCEPTS

- Digital dermatitis lesions are most usually confined to an area formed by a triangle between the accessory digits (dew claws) and the cleft between the bulbs of the heels at the posterior end of the interdigital cleft.
- DD is a highly contagious condition spread from one animal to another via contaminated soil or slurry.
- About 90–95% of DD lesions occur in the hind feet. In individual herds, prevalence of the disease may be as high as 50%.

It has been proposed that cows affected by DD produce 30–45% less milk per day when they are 100–200 days into their lactation. In California alone, this disease is costing the dairy industry US\$1.5–5.0million annually. It has been estimated that the economic loss from one case of DD is US\$80–128/cow/lactation.

DD is, by definition, primarily an acute inflammation of the hairy skin (dermatitis). It may spread into the interdigital cleft or undermine the bulb, thus including the modified skin of the claw.

A badly affected animal will be lame and/or may hold its foot from the ground and/or walk on its toes. There is no associated digital swelling or fever as compared with foot rot. Early lesions are characteristically discreet, circular to oval (0.5–1cm diameter),

hairless (alopecic), moist, red or tan, prone to bleed, and very painful plaques with granular or velvet-like surfaces often edged with a halo of white tissue.

#### TECHNICAL COMMENTS

In some publications, the word 'spirochaete' is used synonymously with spirochaeta. *Spirochaeta* spp. are one of eight genera of the phylum spirochete. No member of the genus *Spirochaeta* has been implicated in digital dermatitis (DD).

Over time, different workers have described the clinical appearance of two very similar conditions, namely, digital dermatitis and papillomatous digital dermatitis (PDD). The disease has also been referred to as interdigital papillomatosis. There may be some slight differences between clinical cases, but there is a general consensus that they are all one disease and that *Treponema* spp. are the most likely causal organisms.

See Figures 15-14–15-20.

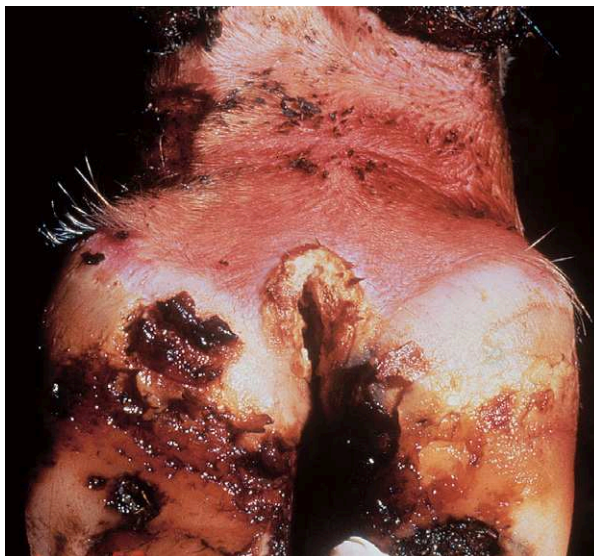


Figure 15-14 Digital dermatitis in its very earliest stage is indistinguishable from interdigital dermatitis. (Courtesy of C M Mortellaro)





**Figure 15-15** The typical lesion is said to resemble a strawberry. It is a lesion that is slightly rough, red, circular, and surrounded by a halo of white cells which clearly separates the diseased tissue from healthy skin. (Courtesy of C M Mortellaro)



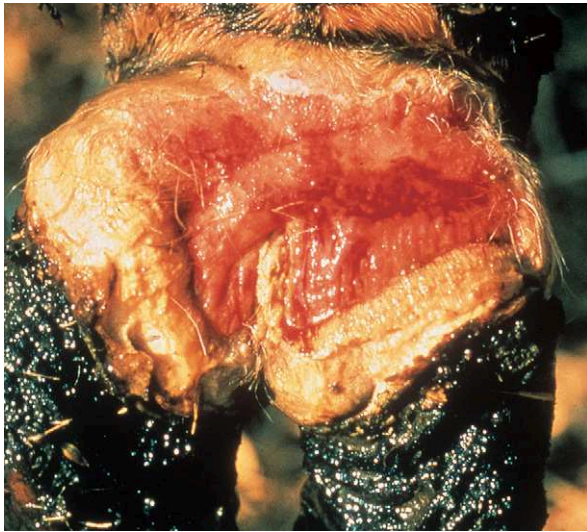
**Figure 15-17** This form of the disease can expand to encroach upon the horn of the heel bulb. (Courtesy of C M Mortellaro)



**Figure 15-16** As the lesion matures, the surface may become rough with long papillomatous strands. (Courtesy of C M Mortellaro)



**Figure 15-18** A distinctly different form of the disease is said to be 'erosive.' (Courtesy of C M Mortellaro)



**Figure 15-19** This form of the disease can progress to involve a considerable area of the skin between the heels and the dew claws. (Courtesy of C M Mortellaro)



**Figure 15-20** Digital dermatitis can have a very variable appearance. However, it is the location of the lesion that is the most significant diagnostic feature of this disease. (Courtesy of C M Mortellaro)

## Cause

### KEY CONCEPTS

It is hypothesized that either:

- The causal organisms of digital dermatitis and interdigital dermatitis are both present at the same time and work synergistically to penetrate the skin; or
- The causal organism of interdigital dermatitis and/or a combination of organisms destroys the superficial layers of the epidermis in preparation for invasion by the spirochetes.

The erosive form of the disease is more common in Europe and the papillomatous form is more frequently encountered in North America.

There is very considerable controversy about the exact pathogenesis of this disease. The primary organism consistently isolated from DD lesions is a spirochete.

Animals may be predisposed to DD by the prolonged exposure of digital skin to oxygen-depleted, wet, and organic material containing the causative organism(s).

Management conditions that may be involved are poor drainage, accumulation of feces and urine on floors, dirty, wet or uncomfortable bedding areas, and overcrowding.

Once the skin has been rendered vulnerable, the superficial layers of the epidermis may be further degraded by bacterial action, making way for the entry of the spirochete. Apparently a synergistic interaction by different bacteria supporting each other is required. This might explain why experiments using spirochetes alone failed to produce lesions even if the skin was damaged by scratching beforehand.

A genetic predisposition might be involved; the properties of the epidermal barrier could be less strong in some animals. Lack of micronutrients, minerals, and vitamins can result in a weaker skin barrier. Disturbances in the local immune system might be involved or mechanical injuries, hyper-hydration of skin epidermis, or hygienic problems may be implicated.

Young animals are particularly susceptible. However, it appears that some degree of immunity may be acquired over time by continued exposure to the infection.

The disease is introduced into a herd by replacement cattle, human beings, or vehicles. Unsterilized equipment used in hoof trimming could be an important source of the disease.

Members of two genera of spirochete have been isolated from biopsies of DD lesions – *Borrelia* spp. and *Treponema* spp.

- Genus *Treponema*: 20 species of *Treponema* have been recognized which are microaerophilic or aerobic. They are helical or flattened coils with an amplitude of up to 0.5µm. Treponemes are found in the intestines of cattle.
- Genus *Borrelia*: 31 species of *Borrelia* have been identified. The organism measures 8–30 × 0.2–0.5µm and has 5–7 coils with an amplitude of approximately 1µm. It is microaerophilic.

The spirochetes proliferate close to the basal layers of the living epidermis. Their presence can have one of two results:

- The erosion of the epidermis – in this case, the living epidermis will be destroyed.
- Stimulation of cells to proliferate and form papillae – in this case, it is assumed that the mitotic cells of the living epidermis are stimulated to reproduce more rapidly than normal.

## TECHNICAL COMMENTS

A range of different organisms (*Dichelobacter nodosus*, *Bacteroides fragilis*, *Bacteroides capillosus*, and *Corynebacterium pseudotuberculosis*) have been isolated sporadically from the lesions.

The most popular hypothesis is that *Dichelobacter nodosus* acts synergistically with a spirochete. It is suggested that the reason for so few bacteria other than *Dichelobacter nodosus* being present in lesions of DD is that the toxin produced by spirochetes inhibits the growth of other bacteria.

The phylum of spirochetes is classified into eight genera primarily on the basis of habitat, pathogenicity, ribosomal RNA sequences, and morphological and physiological characteristics. Spirochetes are Gram-negative, motile, tightly coiled bacteria, slender, and flexuous in shape.

## Differential Diagnosis

### Foot Rot

DD is confined to the skin between the heel bulbs and the dew claws. Foot rot starts as an interdigital disease with swelling eventually affecting the whole digital region and the animal having a raised body temperature.

### Interdigital Dermatitis

ID is primarily a disease of the superficial layers of the epidermis of interdigital space. However, infection can encroach on the skin of dorsal and flexor commissures of the interdigital space. Although ID can be confused with the early stages of DD, the latter condition is more aggressive and rapidly affects numerous animals with typical lesions.

## Treatment

### KEY CONCEPTS

- When the disease is first discovered in a herd, every animal must be examined and appropriate aggressive treatment applied to each affected individual.
- When the first case appears, the cattle will have no natural immunity. If prompt control measures are not introduced, the disease will spread rapidly.

### Treatment of Individual Animals

Each of the four feet must be examined, and each lesion, particularly if papillomatous, scrubbed using soapy water and a very stiff brush. The lesion should be dried. Applying an agent to a filthy or debris-encrusted lesion will have no effect at all. Applying an agent to a wet lesion will dilute the effectiveness of the medication.

The topical dressing must be protected by a pad of gauze held in place by an adhesive bandage. Waterproof bandages are problematic because most of them will create anaerobic conditions which are ideal for the bacteria to grow. It is recommended that less severe lesions should be left open after cleaning. Topical treatment with tetracycline spray on two or three occasions is usually sufficient.

Larger and deeper lesions should be covered for reasons of protection but also to prevent spreading of bacteria. A reusable device such as a 'Bootie' (Mountain Meadows, Providence, Utah 84332, USA) can be extremely useful. A small sanitary napkin has been found to be useful in keeping medication in place beneath a bootie or bandage.

The following agents when mixed with water (de-ionized) to form a paste have been found effective:

- 10g of oxytetracycline powder
- Terramycin-343<sup>®</sup> soluble powder
- Lincomix<sup>®</sup> soluble powder
- Oxytetracycline spray (Cyclo spray vet Novartis).

One treatment may be effective for relatively mild infections, but repeated applications may be called for in more extensive lesions. External treatment has not been shown to produce antibiotic levels in the milk.

### Treatment of Individual Animals if More than 10% of the Herd Have Lesions

All advanced lesions must be given topical treatment as described above. However, the heels of the remainder of the herd should be washed with a low-pressure hose until the details of any lesion that may be present can be clearly seen. Topical treatment should be applied using a 500mL spray bottle or a garden-type spray.

Under free-stall conditions, the treatments can be carried out with the animals fastened in automatic headlocks. This treatment should be continued for 3 weeks, using either antibiotic or non-antibiotic preparations. Oxytetracycline has proved significantly more effective than the last two chemicals in this list:

- Oxytetracycline solution (100mg/mL)
- Lincomycin/Spectomycin
- A solution containing 25mg/mL of oxytetracycline and 20% glycerine in de-ionized water
- Valnemulin (Novartis) 100mg/mL
- Lincomycin (Upjohn) 0.6mg/mL
- Hoof Pro Plus, a non-antibiotic acidified copper (SSI Corporation, Julesburg, Colorado)
- Acidified sodium chlorite solution (prototype alcide bovine hoof treatment, Alkide Corporation, Redmond, Washington).

A 10% solution of formalin may also be used alternately with an antibiotic, but extreme care must be taken to avoid spraying this chemical on the udder or other areas of healthy skin.

### Foot Baths

### KEY CONCEPTS

- Cows should go through a cleansing bath or spray stem before entering a medication bath.
- The water in wash baths should be continuously replaced.
- Medicated bath must be refreshed after a prescribed number of cow passages.
- Cows should go through the foot bath after milking to reduce the possibility of contaminating the milk.
- A bath must be at least sufficiently long for a cow to make two steps with all four feet.

Foot baths have been used extensively to treat and/or control DD. The use of this technique has tended to decline in North America in favour of topical treatment. Foot baths are difficult to use and some medications such as formalin are less effective as the temperature drops. However, the main reason for veterinary surgeons not recommending this technique as frequently as they used to is that many farmers mismanage the procedure. That is to say, the baths are not cleansed with sufficient frequency. There is also concern that disposal of the solutions into the environment will cause pollution.

Common antibiotic footbath solutions (per 200 litres of water) consist of:

- 125g of lincomycin (Lincospectin 100; Upjohn)
- 6–8g/L of oxytetracycline
- erythromycin (690mg/L).

Some commercial non-antibiotic preparations are coming on the market such as:

- Double Action™
- Victory
- Kovex foam preparation (Ecolab)
- Hoof Pro Plus (SSI Corporation, Julesburg, Colorado).

The use of copper sulfate, zinc sulfate, or formalin in foot baths has given inconclusive results when used alone. However, these foot baths may have a beneficial effect if used between antibiotic treatments. The medications would reduce the prevalence of interdigital dermatitis and thus, perhaps, decrease the susceptibility for digital dermatitis.

Antimicrobial resistance to antibiotics such as oxytetracycline is starting to be reported; therefore, the type of antibiotic used should be changed every 6 months. Antibiotics in foot baths are prohibited or not recommended in Europe.

## Prevention and Control

### Immunization and Vaccines

Spirochetal vaccines have been developed and are effective in controlling certain diseases in animals and man. Furthermore, humoral antibodies against spirochetes have been found in cows affected with DD and no antibodies in cows without DD. This indicates that the organisms do cause an immune response in affected cows. This encourages the concept that vaccination against DD will sooner or later become possible. Scientifically controlled trials have not established that any commercially available vaccine gives satisfactory results.

### Husbandry

Good hygiene is the single most important factor in controlling DD. Slurry removal at short intervals is essential and good drainage of alleyways should be implemented. Excessive floor washing should be avoided if rapid run off is not taking place.

In herds where this condition is not yet a problem, it is recommended that if replacement cattle are to be allowed into the herd they should be isolated for one month, and then carefully examined before they are introduced to the rest of the herd.

## HEEL HORN EROSION *EROSIO UNGULAE* (SLURRY HEEL)

### Introduction

Heel horn erosion (HHE) was only given international recognition in 1976. Prior to this date, it was given a variety of colloquial names such as 'stable foot rot', and 'stinky foot'. Very few descriptions of the disease appear in the literature. It has been found that at least 50% of a herd can be affected with erosion of the heel.

### Description

#### KEY CONCEPT

- This is a progressive destruction of heel horn commencing on the axial surfaces of the bulbs of the heels.

Heel horn erosion is usually more extensive the older the animal becomes. It commences between the cheeks of the heel bulbs. In young animals, it may appear as discrete craters which coalesce over time. Gradually, the lesion involves a greater area of the claw capsule. The lesions rapidly become darker in color, typically form a series of ridges, and often end as a dark V-shaped erosion. The discolored horn is much softer than normal horn.

Uncomplicated cases cause the animal very little discomfort. However, after a time, as more heel horn is destroyed, the longitudinal balance of the claw (p. 174) is disrupted. If weight-bearing is moved forward as a result of this process, the formation of a sole ulcer can be precipitated.

In extreme instances, the build-up of heel horn can be so extreme that the pressure causes an inflammatory reaction to pressure in the corium of the heel. An alternative explanation is that pain caused by the hard edge of the skin/horn junction decreases wear of the heel horn which grows faster than it wears. Overburdening often causes the posture to become 'cow hocked.' Correct trimming will correct this posture.

See Figures 15-21–15-31.

**Differential Diagnosis**

In the literature, this condition is sometimes confused with under-running of the heel. Under-running of the heel is most frequently a complication of white line disease, which is a frequent sequel to SCL (see p. 105). Occasionally, infection introduced by a foreign body will cause the soft horn of the heel to separate from the corium beneath.

**Cause**

Although heel horn erosion was described over 30 years ago, little progress has been made in understanding its cause. The effect of slurry and invasion by bacteria has been proposed, and the presence of *Dichelobacter*



**Figure 15-22** Coalescence of the small craters to produce large, rough, irregular depressions and or grooves may be the next stage.



**Figure 15-21** In young animals, pitting of the horn may be the first sign of heel horn erosion.



**Figure 15-23** Erosion of the heel is defined as the progressive loss of horn from the bulb of the heel commencing at the axial border. Usually the erosions are V-shaped and progress from the bulbs at the coronary margin towards the heel-sole junction. It is not uncommon that the erosion will appear as concentric rings around the bulb. In this case, there is a lesion of the skin which may support the concept that interdigital dermatitis and heel erosion have a common causal bacterium. More severe forms with open connections to the corium are now becoming more common.



Figure 15-24 A very deep black groove in the shape of a 'V' is a commonly seen lesion. In this picture, an interdigital dermatitis lesion is seen between the bulbs. This supports the suggestion that heel erosion and interdigital dermatitis have a common cause.



Figure 15-26 Complete erosion of the heel bulb causes weight-bearing to be pushed forward over the location of the flexor process and the resulting pressure causes a sole ulcer to develop.



Figure 15-25 Irregular cavities and ridges are sometimes seen in the heels and axial surfaces of the claws of dairy cows; the horn is nearly always jet black. (Courtesy of Anon)



Figure 15-27 In this case heel horn erosion is associated with digital dermatitis. The heel horn has increased in thickness while, at the same time, it has been eroded. The rear edge of the eroded heel causes abnormal pressure on the dermis of the bulb which can lead to further complications.



Figure 15-28 As the disorder progresses, horn builds up beneath the bulb of the lateral claw, sometimes on both claws. This appears to cause a pressure ridge because at this stage the animal shows signs of lameness.



Figure 15-29 This is a cross-section through the heel of a claw with heel erosion. In this case, the grooves around the heel coincide with layers of blood running in the sole. This suggests that laminitis might be a predisposing factor in the etiology of heel horn erosion.

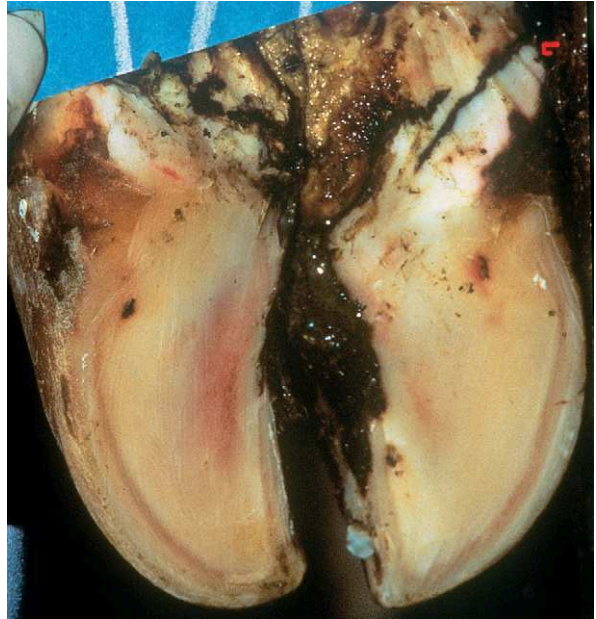


Figure 15-30 Eroded areas have been cut away from the heel. Layers of sole horn are revealed. This also suggests that subclinical laminitis could increase the susceptibility for heel horn erosion.



Figure 15-31 Removing excess horn and sloping the heel horn to ensure weight-bearing on the abaxial wall is useful.



(*Bacteroides nodosus*) has been demonstrated with direct immunofluorescence in the germinal cell layers. The late Egbert Toussiant-Raven believed the condition to be encountered more commonly in animals affected with subclinical laminitis.

## Treatment

### KEY CONCEPT

- Routine use of a foot bath with 3–5% formalin is sufficient to keep heel erosion to a minimum provided the practice is not discontinued.

Even though there is a very high incidence of this disorder, only very few cases cause an animal any significant degree of discomfort. On the other hand, it has been found routinely that Holsteins, with an average production of 9,800kg of milk/year and with otherwise sound feet, increased their daily average milk production by 2kg subsequent to the control of heel horn erosions. If gross lesions are corrected during claw trimming, the effectiveness of foot bathing will be improved by allowing medicated solution to reach the otherwise sealed depth of the heel horn erosion.

Another negative effect of the interdigital dermatitis/heel horn erosion complex is that horn production is stimulated, making it necessary for routine claw trimming to be performed more frequently.

If erosion is extensive, the weight-bearing zone of the heel/sole junction will move forward, causing traumatic reaction in the corium. This complication does cause the affected animal to become lame. The horn should be trimmed in such a manner that there is a slope towards the abaxial wall. Most hoof trimmers will spray the cut surface of the trimmed horn with a preparation containing copper sulfate or apply Stockholm tar.

As DD and/or ID are often associated with the heel horn erosion the primary disease must be treated to have a long-term improvement. Horn erosions will resolve provided that new lesions do not appear.

## Prevention

Routine claw trimming will prevent the development of advanced lesions. Regular foot bathing during the

winter months reduces the severity of heel erosion. Copper sulfate (5% solutions) and formalin (1–5%) have been found to provide satisfactory results.

## BIBLIOGRAPHY

- Andersson L, Lundström K 1981 The influence of breed, age, body weight and season on digital diseases and hoof size in dairy cows. *Zentralblatt Veterinar Medicin* 28:141–151
- Basset H F, Monagan M L, Lenham P, Doherty M L, Carter M E 1990 Bovine digital dermatitis. *Veterinary Record* 126:164–165
- Berg J N, Brown L N, Ennis P G, Self H 1976 Experimentally induced foot rot in feedlot cattle fed rations containing organic iodine (ethylenediamine dihydroiodide) and urea. *American Journal of Veterinary Research* 37:509–512
- Berg J N, Maas J P, Paterson J A, Krause G F, Davis L E 1984 Efficacy of ethylenediamine dihydroiodide as an agent to prevent experimentally induced bovine foot rot. *American Journal of Veterinary Research* 45:1073–1078
- Bergsten C, Pettersson B 1992 The cleanliness of cows tied in stalls and the health of their hooves as influenced by electric trainers. *Preventive Veterinary Medicine* 13:229–238
- Berry S L, Graham T W, Mongini A, Arana M 1999 The efficacy of *Serpens* spp bacteria combined with topical administration of lincomycin hydrochloride for treatment of papillomatous digital dermatitis (foot warts) in cows on a dairy in California. *The Bovine Practitioner* 33:6–11
- Berry S L, Maas J, Reed B A, Schechter A 1996 The efficacy of five topical spray treatments for control of papillomatous digital dermatitis in dairy herds. *Proceedings of the American Association of Bovine Practitioners* 29:188
- Berry S L, Read D H, Walker R L 1998 Topical treatment with oxytetracycline or lincomycin HCl for papillomatous digital dermatitis: gross and histological evaluation. *Proceedings of the 10th International Symposium on Lameness in Ruminants, Luzerne, Switzerland*, p 291–292
- Berry S L, Read D H, Walker R L, Hird D W 2002 Etiology, treatment and prospects for vaccination against (papillomatous) digital dermatitis. *Proceedings of the 12th International Symposium on Lameness in Ruminants, Orlando, Florida*, p 5–11
- Berry S L, Read D H, Walker R L 1999 Recurrence of papillomatous digital dermatitis (foot warts) in dairy cows after treat with lincomycin HCl or oxytetracycline HCl. *Journal of Dairy Science* 82(suppl 1):34
- Blowey R W, Sharp M W 1998 Digital dermatitis in dairy cattle. *Veterinary Record* 122:505–508
- Blowey R W 1990 Digital dermatitis control. *Veterinary Record* 126:120
- Blowey R W, Carter S D, White A G, Barnes A 1994 *Borrelia burgdorferi* infections in UK cattle: a possible association with digital dermatitis. *Veterinary Record* 135:505–508
- Blowey R W, Done S H, Cooley W 1994 Observations on the pathogenesis of digital dermatitis in cattle. *Veterinary Record* 135:115–117

- Blowey R W 1994 Interdigital causes of lameness. Proceedings of the 8th Symposium of Disorders of the Ruminant Digit, Banff, p 142–154
- Borgmann I E, Bailey J, Clark E G 1996 Spirochete-associated bovine digital dermatitis. *Canadian Veterinary Journal* 37:35–37
- Britt J S, Gaska J, Garrett E F, Konkle D, Mealy M 1996 Comparison of topical application of three products for treatment of papillomatous digital dermatitis in dairy cattle. *Journal of the American Veterinary Medical Association* 209:1134–1136
- Britt J S, Carson M C, Von Bredow J D, Condon R J 1999 Antibiotic residues in milk samples obtained from cows treated for papillomatous digital dermatitis. *Journal of the American Veterinary Medical Association* 215:833–836
- Britt J S, McClure J 1998 Field trials with antibiotic and non-antibiotic treatments for papillomatous digital dermatitis. *Bovine Practitioner* 32:25–28
- Brizzi A 1993 Bovine digital dermatitis. *Bovine Practitioner* 27:33–37
- Chelli R, Mortellaro C 1974 La dermatite digitale del bovino. Proceedings of the 8th International Conference on Diseases of Cattle, Milan, p 208–213
- Cheli R, Mortellaro C M 1986 Digital dermatitis today and tomorrow. Proceedings of the 5th Symposium on Disorders of the Ruminant Digit, Dublin, p 8–13
- Chivers W H 1957 An investigation of bovine interdigital overgrowth. *Veterinary Medicine* 52:191
- Chrino-Trejo M, Woodbury M R, Huang F 2003 Antibiotic sensitivity and biochemical characterization of *Fusobacterium* spp. and *Arcanobacterium pyogenes* isolated from farmed white-tail deer (*Odocoileus virginianus*) with necrobacillosis. *Journal of Zoo and Wildlife Medicine* 34:202–268
- Choi B K, Nattermann H, Grund S, Haider W, Grobel U B 1997 Spirochetes from digital dermatitis lesions in cattle are closely related to treponemes associated with human periodontitis. *International Journal of Systematic Bacteriology* 47:175–181
- Choquette-Lévy L, Baril J, Lévy M, St-Pierre H 1985 A study of foot diseases of dairy cattle in Quebec. *Canadian Veterinary Journal* 26:278–281
- Cirlan M 1982 Hyperplasia interdigitalis in bulls. Proceedings of the 4th International Symposium on Disorders of the Ruminant Digit, Paris, p 23–24
- Clarke B L, Stewart D J, Emery D L 1985 The role of *Fusiformis necrophorum* and *Bacteroides melinogenicus* in the aetiology of interdigital necrobacillosis in cattle. *Australian Veterinary Journal* 62:47–49
- Clark P J 1990 Digital dermatitis control. *Veterinary Record* 126:200.
- Clarkson M J, Downham D Y, Faull W B et al 1996 Incidence and prevalence of lameness in dairy cattle. *Veterinary Record* 138:563–567
- Collick D W 1997 Heel horn erosion. In: Greenough P R, Weaver A D (eds) *Lameness in cattle*. W B Saunders, Philadelphia, p 116–118
- Cornelisse J L, van Asten A J A M, Peterse D J, Toussaint-Raven E 1982 *Campylobacter fecalis* as a participant of the bacterial flora of dermatitis digitalis in cows. Proceedings of the 4th Symposium of Disorders of the Ruminant Digit, Paris
- Cruz C, Driemeier D, Cerva C, Corbenellini L G 2001 Bovine digital dermatitis in southern Brazil. *Veterinary Record* 148:576–577
- Dhawi A, Hart C A, Demirkan I, Davies I H, Carter S D 2005 Bovine digital dermatitis and severe virulent ovine foot rot: a common spirochaetal pathogenesis. *Veterinary Journal* 169(2):232–241
- Demirkan I, Carter S D, Murray R D, Blowey R W, Woodward M J 1998 The frequent detection of a treponeme in bovine digital dermatitis by immunocytochemistry and polymerase-chain-reaction. *Veterinary Microbiology* 60:285–292
- Demirkan I, Walker R L, Murray R D, Blowey R W, Carter S D 1999 Serological evidence of spirochaetal infections associated with digital dermatitis in dairy cattle. *Veterinary Journal* 157:69–77
- Doherty M L, Bassett H F, Markey B, Healy A M, Sammin D 1998 Severe foot lameness associated with invasive spirochetes. *Irish Veterinary Journal* 51:195–198
- Döpfer D, Koopmans A, Meijer F A et al 1997 Histological and bacteriological evaluation of digital dermatitis in cattle with reference to spirochetes and *Campylobacter faecalis*. *Veterinary Record* 140:620–623
- Döpfer D, Willemsen M 1998 Standardisation of infectious claw diseases (Workshop report). Proceedings of the 10th International Symposium on Lameness in Ruminants, p 244–264
- Eddy R G, Scott C P 1980 Some observations on the incidence of lameness in dairy cattle in Somerset. *Veterinary Record* 113:140–144
- Egerton J R, Yong W K, Riffkin G G 1989 Footrot and foot abscess of ruminants. C R C Press, Inc. New York, p 167–189
- Enevoldsen C, Gröhn Y T, Thysen I 1991 Sole ulcers in dairy cattle: association with season, cow characteristics, disease and production. *Journal of Dairy Science* 74:1284–1298
- Enevoldsen C, Gröhn Y T, Thysen I 1991 Heel horn erosion and other interdigital disorders in dairy cows associated with season, cow characteristics, disease and production. *Journal of Dairy Science* 74:1299–1309
- Esselmont R J, Peeler E J 1993 The scope for raising margins in dairy herds by improving fertility and health. *British Veterinary Journal* 14:537–547
- Esselmont R J, Spincer I 1993 The incidence and cost of diseases in dairy herds. DAISY report 2. Department of Agriculture, University of Reading, UK
- Espinasse J, Savey M, Thorley C M, Toussaint Raven E, Weaver A D 1984 Colour Atlas on Disorders of Cattle and Sheep Digit – International Terminology. Editions du Point Vétérinaire, Maisons-Alfort
- Frisch J E 1976 The comparative incidence of foot rot in *Bos Taurus* and *Bos Indicus* cattle. *Australian Veterinary Journal* 52:228–229
- Greenfield J, Bigland C H, Milligan J D 1972 Control of bovine foot rot by treatment of feedlot litter with

- paraformaldehyde. *British Veterinary Journal* 128: 578–583
- Greenough P R 1962 Observations on some of the diseases of the bovine foot. *Veterinary Record* 74:1–9, 53–63
- Gupta R B, Fincher M G, Bruner D W 1964 A study of the aetiology of foot-rot in cattle. *Cornell Veterinarian* 54:66–67
- Gyorkos I, Kovacs K, Mezes M, Bader E, Nyakas I 1999 Influence of digital dermatitis on milk production in dairy cows. *Alattenyesztes es Takarmanyozas* 48:483–489
- Hanna P, Lofstedt J, Duivenvoorden P 1994 Papillomatous digital dermatitis in a Canadian dairy herd. *Canadian Veterinary Journal* 35:657
- Hartog B J, Tap S H M, Pouw H J, Poole D A, Laven B A 2001 Systemic activity of erythromycin in cattle when applied by footbath. *Veterinary Record* 148:782–783
- Hernandez J, Shearer J K, Webb D W 2002 Effect of lameness on milk yield in dairy cows. *Journal of the American Veterinary Medical Association* 220:640–644
- Hussein H A, Hanna A T 1984 Isolation and identification of *Fusobacterium necrophorum* and *Bacteroides nodosus* from foot rot of cattle in Baghdad. *Journal of Biological Sciences, Biological Research Centre, Baghdad, Iraq* 15:57–69
- Kanoe M, Imagawa H, Toda M 1975 Distribution of *Fusobacterium necrophorum* in bovine alimentary tracts. *Bulletin of the Faculty of Agriculture, Yamaguti University, Japan* 26:161–172
- Laing E A, Egerton J R 1978 The occurrence, prevalence and transmission of *Bacteroides nodosus* infection in cattle. *Research in Veterinary Science* 24:300–304
- Laven R A, Hunt R 2001 Comparison of valnemulin and lincomycin in the treatment of digital dermatitis by individually applied topical spray. *Veterinary Record* 10:302–303
- Laven R A, Proven M J 2000 Use of an antibiotic footbath in the treatment of bovine digital dermatitis. *Veterinary Record* 147:503–506
- Leist G, Rudolph R, Natterman H 1998 Digital dermatitis: a histopathological evaluation and some new aspects in the pathogenesis of a multifactorial disease. *The Bovine Practitioner* 32(2):71–74
- Lindley W H 1974 Malignant verrucae of bulls. *Veterinary Medicine* 69:1547–1550
- Madigan T M, Martinko J M, Parker J 2003 *Brock: Biology of Microorganisms*, 3rd edn. Prentice Hall, New Jersey
- Mortellaro C M 1994 Digital dermatitis. *Proceedings of the 8th International Symposium on Disorders of the Ruminant Digit, Banff*, p 137–141
- Murry R D, Downham D Y, Demirkan I, Carter S D 2002 Some relationships between spirochete infections in digital dermatitis in the feet of UK dairy herds. *Research in Veterinary Science* 73:223–230
- Nutter W T, Moffitt J A 1990 Digital dermatitis control. *Veterinary Record* 126:200
- Philipot J M, Pluvinage P, Luquet F 1994 Clinical characterization of a syndrome by ecopathology methods: an example of dairy cow lameness. *Veterinary Record* 25:239–243
- Read D H, Walker R L, Castro A E, Sundberg J P, Thurmond M C 1992 An invasive spirochaete associated with interdigital papillomatosis of dairy cattle. *Veterinary Record* 130:59–60
- Read D H, Walker R L 1994 Papillomatous digital dermatitis: pathologic findings. *Proceedings of the 8th International Symposium on Diseases of the Ruminant Digit, Banff*, p 156–157
- Read D H, Walker R L 1996 Experimental transmission of papillomatous digital dermatitis (PDD) in cattle. *Veterinary Pathology* 33:607
- Read D H, Walker R L 1998 Comparison of papillomatous digital dermatitis and digital dermatitis of cattle by histopathology and immunohistochemistry. *10th International Symposium of Lameness in Ruminants, Lucerne*, p 268–270
- Read D H, Walker R L 1998 Papillomatous digital dermatitis (foot warts) in California dairy cattle. *Journal of Veterinary Diagnostic Investigation* 10:67–76
- Reed B, Berry S L, Maas J P, Schechter A 1996 Comparison of five topical spray treatments for control of digital dermatitis in dairy herds. *Journal of Dairy Science* 79(suppl 1):189
- Rebhun W C, Payne R M, King J M, Wolfe M, Begg S N 1980 Interdigital papillomatosis in dairy cattle. *Journal of the American Veterinary Medical Association* 177: 437–440
- Rodriguez-Lainz A, Hird D W, Carpenter T E, Read D H 1996 Case-control study of papillomatous digital dermatitis in Southern California dairy farms. *Preventive Veterinary Medicine* 28:117–131
- Rodriguez-Lainz A, Hird D W, Walker R L, Read D H 1996 Papillomatous digital dermatitis in 458 dairies. *Journal of the American Veterinary Medical Association* 209:1464–1467
- Rodriguez-Lainz A, Melendez-Retamal P, Hird D W, Read D H, Walker R L 1999 Farm- and host-level risk factors for papillomatous dermatitis in Chilean dairy cattle. *Preventive Veterinary Medicine* 42:87–97
- Rutter B 1984 Lameness in dairy cows: incidence in Argentina. *Proceedings of the 8th International Symposium on Disorders of the Ruminant Digit, Banff*, p 40
- Shearer J K, Elliot J B 1998 Preliminary results from a spray application of oxytetracycline to treat, control, and prevent digital dermatitis. *Proceedings of the 8th International Symposium on Disorders of the Ruminant Digit, Banff*, p 182
- Shearer J K 1998 Lameness in dairy cattle: laminitis, claw disease, digital dermatitis, and foot rot. *Veterinary Record* 79:189
- Shearer J K, Hernandez J 2000 Efficacy of two modified non-antibiotic formulations (Victory) for treatment of papillomatous digital dermatitis in dairy cows. *Journal of Dairy Science* 83:741–745
- Stamm L V, Bergen H L, Walker R L 2002 *Journal of Clinical Microbiology* 40:3463–3469
- Thorley C M, Calder H A Mc L, Harrison W J 1977 Recognition in Great Britain of *Bacteroides nodosus* in foot erosions of cattle. *Veterinary Record* 100:137

- Toussaint Raven E, Cornelisse J L 1971. The specific contagious inflammation of the interdigital skin in cattle. *Veterinary Medical Review* 2/3:222–247
- Trott D J, Moeller M R, Zuerner R L et al 2003 Characterization of *Treponema phagedensis*-like spirochetes isolated from papillomatous digital dermatitis lesions in dairy cattle. *Journal of Clinical Microbiology* 41:2522–2529
- Tulasne J J, Béguin J C 1982 Ovine foot rot: general report. Proceedings of the 4th International Symposium on disorders of the ruminant digit, Paris
- Walker R L, Read D H, Loretz K J, Nordhausen R W 1995 Spirochete isolated from dairy cattle with papillomatous digital dermatitis, interdigital dermatitis. *Veterinary Microbiology* 47:343–355
- Walker R L, Read D H, Loretz K J, Hird D W, Berry S L 1997 Humoral response of dairy-cattle to spirochetes isolated from papillomatous digital dermatitis lesions. *American Journal of Veterinary Research* 58:744–748
- Ward W R 1994 The minimal solution footbath – an aid to treatment of digital dermatitis. Proceedings of the 8th International Symposium on Disorders of the Ruminant Digit, Banff, p 184
- Wells S J, Garber L P, Wagner B A 1999 Papillomatous digital dermatitis and associated risk factors in US dairy herds. *Preventive Veterinary Medicine* 38:11–24
- Wells S J, Garber L P, Wagner B, Hill G W 1997 Papillomatous digital dermatitis on U.S. dairy operations (foot warts). National Animal Health Monitoring System (NAHMS) 1–29
- Yeruham I, Elad D, Perl S, Ram A 2003 Necrotic-ulcerative dermatitis on the heels of heifers in a dairy infected with *Corynebacterium pseudotuberculosis*. *Veterinary Record* 152:598–600
- Zemljic B 1994 Current investigations into the cause of dermatitis digitalis in cattle. Proceedings of the 8th International Symposium on Disorders of the Ruminant Digit, Banff, p 164–167

## Other Conditions Affecting the Digital Region

### TRAUMATIC INJURIES TO THE SOLE

#### Bruising of the Sole

##### GLOSSARY

**Overloading:** A disproportionate amount of weight being borne by one claw or a region of one claw. Damage results from pressure to the dermis of the sole.

##### KEY CONCEPTS

- Bruises (purple) are of pure traumatic origin while hemorrhages in the sole and white line are referred to as being symptomatic of subclinical laminitis with both metabolic and traumatic components to the cause.
- It is not possible to distinguish a pure bruise from a laminitic-caused hemorrhage unless a history of trauma is known.

#### **Description**

In practice, it is very difficult to identify the difference between a bruise and subclinical laminitis hemorrhages. There is probably a great deal of overlap between the signs of a bruise and that of the subclinical laminitis hemorrhage. The clinical signs of bruising are:

## 222 16 / Other Conditions Affecting the Digital Region

- Predominantly a blue/purple coloration of the sole horn (Fig. 16-1).
- The sole may be flexible to digital pressure.
- Pressure with testing calipers may elicit pain.
- A history of the animal walking on rough roads or trackways.
- Obvious signs of excessive wear.
- Recent, over zealous claw trimming.

In other words, bruising can occur solely as the result of trauma. If the disorder goes unrecognized, the sole will gradually disintegrate and lameness will become more pronounced. In rare instances, if the corium itself is severely damaged the horn repair will be very complicated under field conditions.

Hemorrhages in the sole are exposed when overloaded claws are trimmed (Fig. 16-2). Hemorrhages are very commonly seen in the claws of first-calving heifers, particularly after the animals may have experienced a dramatic change in diet at the same time they were moved from a soft footing to concrete. Therefore, the history should also be taken into consideration as well as the appearance of the lesion.

It is impossible to be dogmatic about the typical appearance of a sole of an animal affected with subclinical laminitis (SCL, Fig. 16-3). The sole of a claw may have a yellow tinge which may be due to the escape

of serum. A similar yellowish tinge is caused by staining from manure. However, in a trimmed claw staining by manure will not be present. In other words yellow coloration of recently trimmed sole horn will be a clinical sign of SCL. The hemorrhage typical of SCL tends to be diffuse and some will show the characteristic 'brush mark.' It is likely that more than one claw would be affected, and within a group of animals several would have claws very similar in appearance.

Animals with SCL do not appear lame as is the case with bruising. However, they have a characteristic gait; they walk carefully, they are said to look as if they are 'walking on eggs.' Not every animal will be at the same stage of lactation when examined; therefore, feed intake will vary and this affects the rate of horn production and quality. This means that not every animal will be subjected to the same stress and their claws will appear different one from the other.



**Figure 16-1** A blue or purple discoloration of the sole is indicative of bruising. Flexibility of the horn and sensitivity to pressure are other indicators. (Courtesy of J Malmo)



**Figure 16-2** Prior to trimming this was a grossly overloaded claw. Ranging from dark blue to red this picture demonstrates the range of color possible in a 'bruised' sole.



**Figure 16-3** The hemorrhage seen in these claws is more typical of those seen in association with subclinical laminitis. (Courtesy of J Malmo)

### Cause

Most cases of bruising result from prolonged walking over rough roadways or tracks. Lumps of ice in dirt lots can cause similar damage. Stress from social confrontation in herds confined on hard, abrasive floors can cause low ranked animals to be chased around. Animals in estrus could cause over wear of the bearing wall and sole.

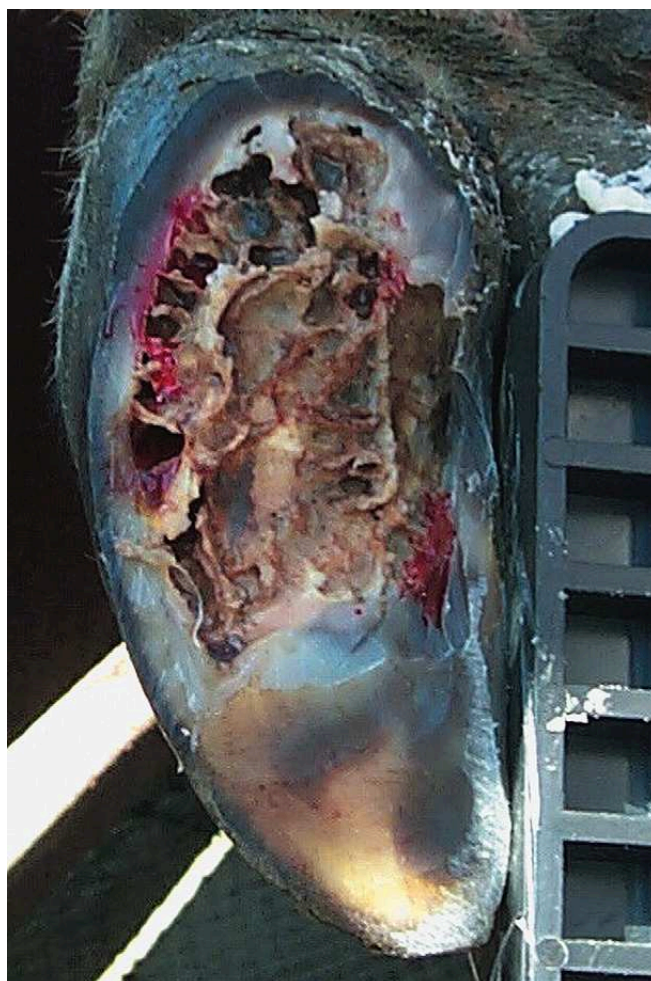
Care must be taken after claw trimming that cattle are not forced to walk even for short distances on hard, rough surfaces. Claw trimming exposes soft, temporarily vulnerable soft horn after old, dry, and tough layers of horn are removed. In the first days after a trimming session, during the cold season, some degree of accelerated wear of the claw will take place and this has to be taken into account by leaving those claws a little longer ( $\frac{1}{8}$  inch or 0.3–0.5 mm). Over-trimming itself, often the use of a grinder in inexperienced hands – and especially in combination with subsequent exposure to rough concrete or asphalt alleys – can cause severe damage to individuals or a group of animals.

### Treatment

The resolution of a bruise and/or complications following a bruise depends on the animal's ability to

grow a new sole. Pressure stimulates horn production; therefore, most cases will respond spontaneously if the animal can be confined entirely to an area very deeply bedded with straw, on rubber mats, or exposed to grass or sand. However, if the sole of a claw has been fragmented, protection must be provided and the patient must be prevented from walking. The best treatment is to use a shoe, such as a 'Shoof,' on all affected feet. Alternatively a 'lift' can be applied if one of the claws is unaffected. Bandages are best avoided as the fabric acts as a wick drawing moisture to the sole, preventing it from hardening. However, bandages impregnated with Stockholm tar may have a beneficial effect in stimulating the growth of healthy sole horn.

See Figure 16-4.



**Figure 16-4** This is the appearance of a claw that has been severely destroyed by road work. Applying a lift and protecting the open surface from further damage can result in the recovery of lesions of this type. (Courtesy of J Malmo)

**Control**

Claw trimmers must warn clients of the dangers involved in forcing the cattle to walk on hard surfaces, such as rough concrete or graveled pathways, for some days after trimming – particularly in wet weather. As the moisture content of the claw horn increases, so it will become softer and vulnerable to wear. Also with animals housed on newly constructed concrete floors, it could be detrimental to trim the claws as severely as usual. Trimmers must, in these cases, reduce trimming to a minimum and avoid excessive reduction of the bearing surface of the wall, but at the same time leaving just enough to achieve a good balance of weight distribution.

Claw trimmers should also be aware that the minimum dimensions of the claw capsule after trimming are not an absolute goal. Trimming must be made according to the environment where the cow lives. If the cows are forced to live on concrete, the thickness of the sole is like money; you can never have enough of it. Trimming in this case is aimed at restoring the correct angle between the dorsal surface and the bearing surface ( $\approx 45^\circ$ ) and at preserving the highest possible bulb.

When cattle habitually walk for long distances, the use of rubberized roll matting has proved to be invaluable. These mats measure about one meter in width. Cattle can be seen walking along, single file, on these strips of fabric.

**Foreign Bodies and Abscesses of the Sole****GLOSSARY**

**Foreign Body:** Any sharp object – such as a nail, stone, or piece of glass – capable of becoming embedded in or penetrating the sole of a cow's foot when the animal steps on the object.

**KEY CONCEPTS**

- If the foreign body does not penetrate the sole, pain causing lameness will occur each time the animal bears weight on the affected claw. However, the foreign body will cause no pain if the sole is very thick, but it will gradually work its way through the sole until it penetrates to the corium.
- If the foreign body does penetrate the sole, infectious agents will enter the claw capsule and a localized abscess will result.

**Description**

An abscess located under the front half of the sole will cause severe, rapidly increasing lameness (because the abscess will be confined between two hard surfaces, i.e., bone and horn). Abscesses under the bulb of the heel will cause less severe pain; lameness increases slowly (because the abscess is confined between two flexible structures, i.e., horn of the heel bulb and the digital cushion).

If the bearing surface of the claw has worn flat, there will be more surface area through which a foreign body can penetrate (Fig. 16-5). That is to say, there is an increased area at risk. If the sole is softer than normal due to a high moisture content, it will be more vulnerable to damage, as it will be if the sole horn is softer as the result of subclinical laminitis.

**Treatment**

Remove the foreign body with the hook of a hoof knife. Use the hook of the knife to explore the depth of the



**Figure 16-5** A foreign body may be a splinter of glass, stone, or nail which is buried in the sole of a claw.



cavity, employing a coring action. If an abscess is present, there will be a sudden release of purulent material. The pus may be black if the infection has entered from the environment.

The cavity occupied by the abscess should be flushed out with water expressed forcibly from a hypodermic syringe and then dried with a swab. The size of the cavity may be determined by introducing a flexible probe. The pressure inside the claw is usually so considerable that dead space will fill very rapidly. It is a wise precaution to dress the wound with an antibiotic (powder or intermammary cerate) and plug the hole with cotton batten. The plug can be held in place for a short period with adhesive bandage wrapped around the claw.

If it is suspected that considerable tracking may have taken place, a radiographic study would be useful. The gas present in an extensive lesion will clearly show the extent of the cavity in a radiograph. Heroic horn removal to open the entire track is contraindicated. Dead space inside the claw is rapidly eliminated by the very high pressures generated by weight-bearing. The objective must be to prevent infection from becoming established and allow healing to take place. The entire track should be filled with a bacteriocidal, non-irritant agent using a hypodermic syringe and a sterile teat siphon.

### Abscesses of the White Line

(See also pp. 94–95.)

#### KEY CONCEPTS

There are two distinctly different causes of abscesses in the white line:

- External infection penetrates from the outside; the pus is usually black.
- Internal pressures following the collapse of the pedal bone support system (PBSS; see p. 20) under the influence of matrix metalloproteinases (MMPs). The integrity of the white line is torn apart creating an inflammatory process which results in the production of a cream-colored pus.

#### Description

Most white line abscesses are located in the posterior part of the outer wall of the lateral hind claw (Zone 3). Foreign bodies may be found embedded in the white line. Removal of the foreign body and exploration of the cavity will release pus if an abscess is present. Tacks

may work up beneath the wall of the claw with several possible results. Pus may be released at the hairline, the joint could be infected or a retroarticular abscess may develop (these possible complications are dealt with elsewhere; see p. 261). Complications are easily missed during an examination, particularly during the early stages of the condition.

See Figures 16-6–16-14.



Figure 16-6 A simple sole abscess caused by external trauma is referred to as a primary lesion. This is a 'normal' white line subsolear abscess without involvement of the corium. Note the black coloration of the pus.



Figure 16-7 Abscesses may sometimes form long tracks inside the claw.

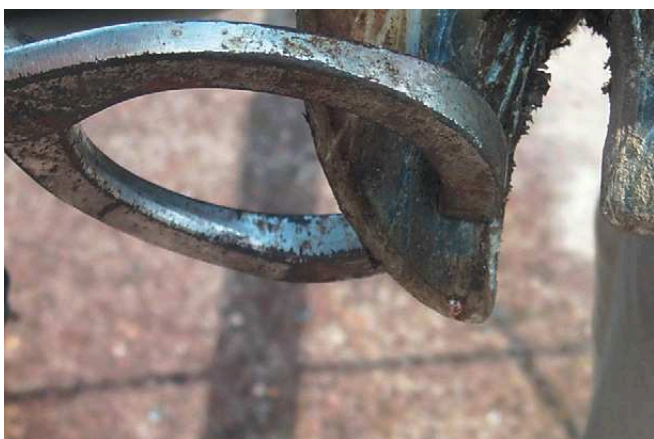


Figure 16-8 The use of hoof testing calipers is very helpful in identifying the location of abscesses beneath the sole of the bovine claw. (Courtesy of J Malmo)



Figure 16-10 A lesion in the white line can track up beneath the claw wall and discharge pus at the coronary band. If a mark is found in the white line it should be explored by removing overlying wall.



Figure 16-9 A stone impacted in the white line in Zone 3 is typically associated with white line abscess originating from the environment. However, the sole hemorrhage might indicate subclinical laminitis. Separation of the sole at the heel is associated with infection introduced by the foreign body. (Courtesy of J Malmo)

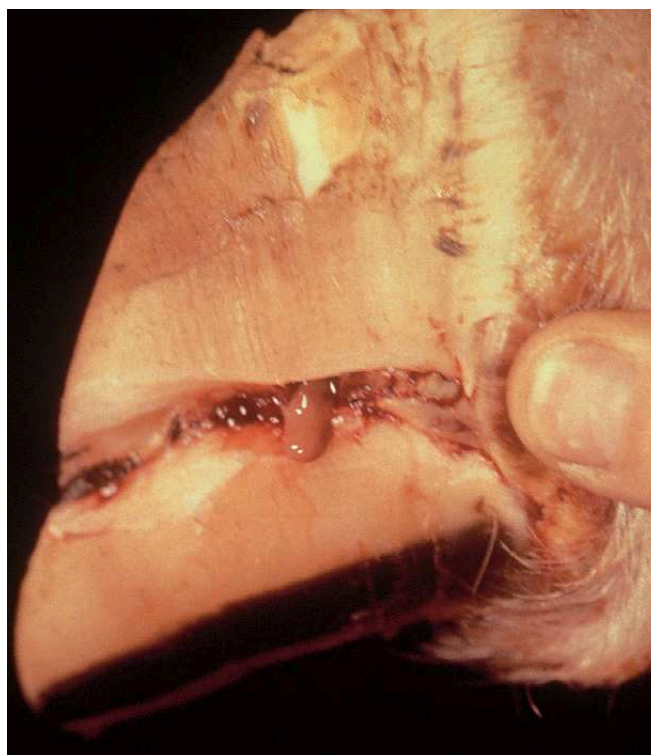


Figure 16-11 In other instances, a lesion in the white line can track up beneath the claw wall and will discharge infection directly into the joint. In this case, pus can be seen oozing directly from the joint.



Figure 16-12 The black mark in the white line near to the toe is extremely small. (Courtesy of J Malmo)



Figure 16-13 Exploration causes the release of pus. (Courtesy of J Malmo)

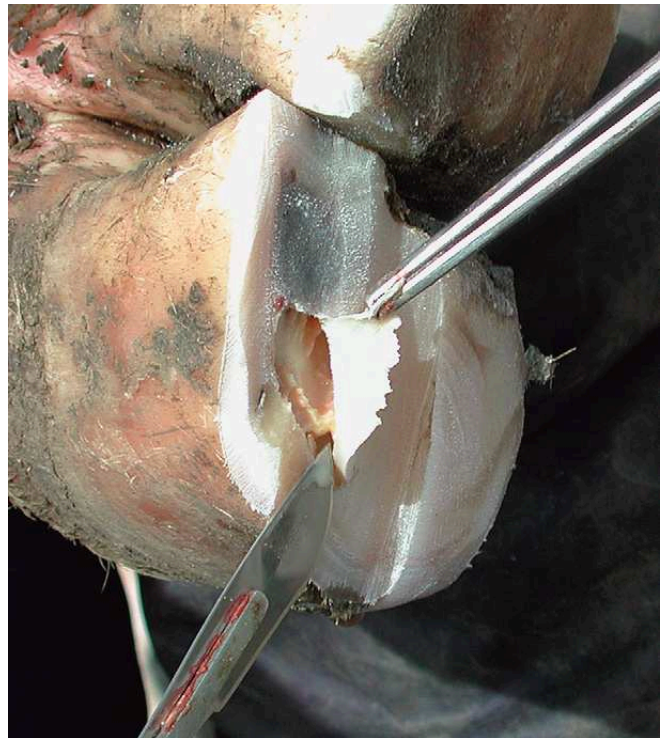


Figure 16-14 Careful dissection of portion of the overlying sole reveals the extent of the damage to the corium. Heroic removal of solear horn is not advocated. A lift should be applied, the cavity should be filled with antibiotic and the lesion protected from further contamination. (Courtesy of J Malmo)

### Cause

The white line is composed of the softest horn in the claw capsule. It is, therefore, the part of the claw capsule most vulnerable to damage by a foreign body. The high rate of horn production in this region is greater than in the adjacent sole. The white line is the remnant of the epidermal lamellae which are susceptible to alterations of the vascular system characteristically occurring during laminitis. This explanation may account for softening of the white line in animals with subclinical laminitis.

Under field conditions it is difficult to differentiate a lesion caused by external trauma from one caused as the result of the collapse of the of the pedal bone support system. Anecdotally, it can be said that perhaps the color of the pus produced is an indicator (cream if internal pressures and black if from external entry).

### Treatment

The pain from an abscess can be localized with a hoof tester, or the haft of the hoof knife gently hammered on a suspected location. The tracks may be extremely

small, but they must be followed so far as they go – even if this is to the coronary band. The rotary saw blade of a Dremel tool may be the easiest way to remove a narrow strip of claw wall. Great care must be taken not to remove more horn than is absolutely necessary but it is essential to remove enough wall horn to expose the full extent of the tracks.

If an abscess is present, pus will usually spurt out under considerable pressure when it is opened. A closed abscess seeks the course of least resistance in order to drain. The drainage track could be to the abaxial coronary border or in the posterior part of the interdigital cleft.

Invariably it is profitable to remove an elliptical portion of the abaxial wall (see Fig. 16-15). When the abaxial wall has been removed it is impossible for

foreign material to be embedded and thus further abscess formation is prevented.

See Figure 16-15.

### Vertical Fissures (Sandcracks)

#### KEY CONCEPT

- Fewer than 0.5% of dairy cows have sandcracks, but the incidence can be as high as 60% in some herds of beef cows.

#### Description

Vertical fissures are cracks that run down the abaxial border of the dorsal surface of the wall. The majority (68%) are found on an outside front claw. Although the incidence of this condition is high in mature Canadian beef cows ( $\approx 20\%$ ), the prevalence of lameness in affected cattle is low. Lameness occurs mostly when the crack becomes infected.

Cracked claws usually become bent and twisted over time. When this occurs, affected beef cows are reluctant to move, grazing time is reduced, and more time is spent lying down. For descriptive and research purposes, sandcracks can be divided into five different types (Figs 16-16–16-20).



Figure 16-15 A useful tip is to remove an elliptical segment from the wall adjacent to a white line abscess. This will provide free drainage and provide a self-cleansing opening on the abaxial wall. (Courtesy of E Toussaint-Raven)

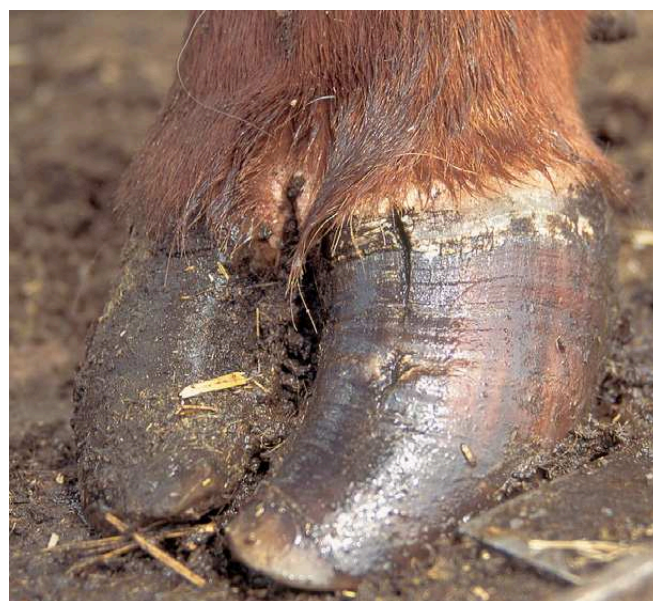


Figure 16-16 Some sandcracks only run a short distance from the coronary band towards the centre of the claw. Commonly found in young heavy beef cattle. (Type one.)



**Figure 16-17** A high percentage of fissures runs from the skin horn junction and terminates in one or more horizontal grooves. This had led to the theory that the horizontal groove comes first, and the dorsal wall of the claw bends, causing mechanical forces that split the horn back to the coronary band. (Type two.)



**Figure 16-19** This and the following photograph illustrate what *may* be the earliest stage in the development of a sandcrack. In the centre of the claw there appears to be evidence of an 'explosive' force. (Type five.)



**Figure 16-18** Sandcracks rarely cause lameness. Eventually the function of the claw is totally destroyed, they become very unsightly and are then brought to the attention of the producer. This problem is relatively common among beef cattle on the Canadian prairies.



**Figure 16-20** In this picture the lesion has the appearance of a rupture which could be the result of mechanical stress of bending. It is purely conjecture that the production of bands of weak horn is responsible for bending and that bending of the dorsal wall can result in a certain type of sandcrack. (Type five.)

**Cause****KEY CONCEPT**

- There is a strong correlation between the incidence of sandcracks and the weight of the animal. Therefore, because an animal increases in weight as it ages, there is also a higher incidence of sandcracks in older cows.

A genetic factor involving the conformation of the forelimb may predispose to cracks appearing only in front lateral claws. Although there is no evidence to support this hypothesis, it has been suggested that the degree to which the foot turns in or out could be implicated.

There is a little more evidence to support the concept that beef cows with horizontal fissures also suffer more frequently from vertical fissures. This theory gains some support from the fact that many vertical fissures appear to originate at a horizontal fissure. When a horizontal groove or fissure grows out as far as the middle of the claw, the dorsal surface commences to bend around the defect (p. 237). It is further proposed that the bending process generates mechanical stresses in the dorsal wall of the claw. The stress is relieved by the appearance of a crack. Half of all sandcracks run the full length of the claw; therefore, these may or may not be associated with a horizontal fissure. On the other hand, 11% of fissures start at a horizontal fissure.

An unusually high prevalence of sandcracks in beef cattle across the Canadian prairies is linked to factors unique to that region. This area is marginally deficient in both copper and zinc. The extremes of climate have given rise to a special system of management. Beef cattle are corralled during the winter months and subsist on forage low in protein and energy but high in fiber. Invariably, these animals are turned out to pasture in the spring only when the grass is lush. This means there is a sudden change in diet which introduces the cattle overnight to pasture, rich in protein and energy, but extremely low in fiber.

**Treatment****KEY CONCEPT**

- The majority of sandcracks do not cause lameness; therefore treatment is rarely required.

If the seat of lameness can be traced to a sandcrack, there is cause for concern. Particularly if the site of the lesion is abaxial to the extensor process, there is a significant risk that the pedal joint could become infected. If the cracks are small and only involve the coronary band, all detached horn should be removed but no part of the dermis (corium) should be touched for fear of penetrating the joint capsule. The lesion should be cleansed and dried. A topical dressing consisting of equal parts anhydrous copper sulfate and sulfamezathine should be applied and protected by a gauze pad held in place by an elastic bandage encircling the entire coronary band. Pressure bandaging is advisable, firstly because exuberant granulation tissue can be a problem, and secondly because the joint capsule is very vulnerable at this location.

Some cattlemen are concerned about the appearance of the claws of valuable and/or show animals. They are concerned that the appearance of the feet will detract from the sale of their stock. The ragged edges of a large sandcrack can be seen to move during weight-bearing. If the crack splits open at the apex of the claw, weight will be borne on each side of the crack, forcing each side apart.

The first step in a cosmetic procedure to improve the appearance of claw with a sandcrack is to cut back as far as possible the axial side of the crack at the apex of the claw. This causes weight to be borne only on one side of the fissure, thus avoiding movement of the two parts of the wall. The edges of the crack are next smoothed out. Holes about 8mm (0.35ins) in diameter are drilled along the edge of the crack angle into the fissure. Fetotomy wire is laced through these holes, like shoe laces, and methyl methacrylate applied as a reinforcement. The material left in place as the crack grows out some 8–12 months later.

See Figures 16-21–16-25.



Figure 16-21 The crack should be opened by removing ragged edges and debris. The circular saw blade or a heavy burr of the Dremmel tool accomplishes this procedure very rapidly.



Figure 16-23 A series of 8mm holes should then be drilled through the wall into the groove. Steel wire is then laced through these holes and across the fissure.



Figure 16-22 Once the crack has been opened, the apex on one side of the fissure should be cut back. If both sides of the crack are bearing weight, the fissure will move and healing will not take place. (Type three.)



Figure 16-24 The crack is then filled with methyl methacrylate.



**Figure 16-25** A claw 8 months after treatment. The portion of the wall closest to the coronary band is growing normally and full resolution can be expected. (Type four.)



**Figure 16-26** The crack coincides with the junction of the axial wall with the heel bulb at the 'axial groove.' The axial groove is the thinnest region of the claw capsule. (Courtesy of J Malmo)

### Control

Careful forage and pasture management can help reduce the incidence of sandcracks. Sudden changes occurring in the spring, when cattle move from a diet high in fiber and low in protein to pasture rich in protein and low in fiber, are believed to cause horizontal fissures. This is discussed in greater detail under horizontal grooves (p. 237). Numerous research reports indicate that biotin is useful in reducing the incidence of this disorder.

### Axial Wall Fissures

#### Description

There are very few reports of this lesion and it can be assumed to be quite rare. Fissures of the axial wall usually occur along the line of the axial groove of the medial fore claw. The cause is unknown; however, this is a lesion that causes lameness.

See Figures 16-26–16-29.



**Figure 16-27** Movement of the lips of an axial fissure exposes the corium beneath. Granulation tissue may develop. Bleeding may be the first sign that a lesion is present. Usually an animal will be lame at this stage. (Courtesy of J Malmo)



**Figure 16-28** This lesion may only be discovered during routine claw trimming. The crack is often the original of horn erosion. (Courtesy of J Malmo)





**Figure 16-29** Removal of necrotic horn and thinning the horn around the groove is usually helpful. Removal of granulation tissue and dressing the wound with an astringent bactericidal dressing are appropriate. (Courtesy of J Malmo)

## Horizontal Fissures (Hardship Grooves)

### KEY CONCEPTS

- Under the general term of 'horizontal groove' there are numerous different changes in the appearance of the claw wall that are significant to the critical observer.
- Grooves, fissures, broken toes, and ridges can be a good indicator of periods of stress, sudden changes in nutrition, or severe febrile disease.
- A groove can be used to indicate roughly when the causal insult occurred.
- The appearance of the claw can be used as a guide when selecting replacement stock.
- The bovine claw increases in length by  $\approx 0.5$ cm (4–8mm horn production in the wall – coronary segment) each month. Knowing this allows the observer to calculate when the event occurred causing the groove.

### Description

The term 'horizontal groove' is used loosely to describe a variety of different appearances in the horn of the wall running parallel to the hair line. Grooves and fissures affect beef and dairy cows alike. If more than 20% of the cows in a herd have grooves, at approxi-

mately the same distance from the hair line, on more than four claws, it is certain that a short-term stress or nutritional problem has occurred.

The deformities associated with grooves are unsightly and affect the saleability of pure-bred beef cattle. Grooves and fissures may play a part in causing sandcracks.

### Weaning Grooves in Immature Animals

Beef calves are weaned at the end of the summer. The change in diet from dam's milk to grass is dramatic. Often, at this time, the calves are dehorned, castrated, vaccinated, transported, and spend time in a market. When the animal finally reaches the feedlot the composition of the ration consists of concentrate and forage, the opportunity to exercise is considerably reduced, and the little animal is subjected to confrontation by other animals. Some animals adapt more readily to these changes than others and the evidence can be seen in the claws.

Dairy heifers are not subjected to such extreme stresses or changes in management. There should be no such abnormalities in the claws of a dairy heifer between 20 and 26 months of age. When this is found not to be the case there is likely to have been some serious error in the earlier management of the animal.

See Figures 16-30 and 16-31.



**Figure 16-30** The band of horn closest to the coronary band was produced after weaning, indicating that the animal failed to adapt properly to the management and nutrition after weaning. The horn at the apex of the claw suggests that the animal was well nourished and unstressed before it was weaned.



**Figure 16-31** A post-weaning band of poor-quality horn is present in the horn closest to the hair/horn junction. As in the preceding picture, this indicates the inability of the steer to adapt to post-weaning feed. However, the horn at the apex of this claw also appears to be of poor quality. This suggests that the management and nutrition may not have been adequate before the animal was weaned.

**The Hardship Groove or Fissure or Thimble or Broken Toe in a Mature Animal**

Groove, fissure, thimble, and broken toe describe the appearance of a lesion at different stages and/or of different severity.

A hardship groove is a depression running around the wall of a cow's claw more-or-less parallel to the hairline. For example, it is not unusual for such a groove to be produced as the result of a hard calving. The hardship groove is nothing more than an indication that the animal was subjected to a short-term stress which could be an acute febrile illness. The date when stress occurred can be determined by measuring its distance from the hair line to the groove (see Fig. 16-37).

The deeper the groove the more severe the insult. Sometimes a 'fissure' will penetrate right through the wall and as it grows closer to the bearing surface it remains attached only by sensitive tissues. A fissure causes considerable discomfort and reduce the animal's

willingness to walk and forage for feed. This may affect productivity. As the fissure grows towards the apex of the claw it is referred to a 'thimble.' When the thimble breaks off, the end of the toe which is left is square. If a herd of cows has a high population of animals with square toes it can be assumed that a problem has been ongoing for many months.

See Figures 16-32–16-43.



**Figure 16-32** A hardship groove is a depression running around the claw wall more or less parallel to the coronary band.



**Figure 16-33** The groove can be so deep that it completely penetrates the whole wall. This is referred to as a *horizontal fissure*. A *buckled claw* is one that is bent around a groove or series of grooves causing the dorsal surface of the claw to become concave.



Figure 16-34 A *thimble* is initially attached only by shreds of dermis. This is extremely painful. The loose fragment can be removed with shears. (Courtesy of J Malmo)



Figure 16-36 The thimble will eventually break off and leave a square end or *broken toe*. If many cows in a herd have broken toes, it is a sure indication that a problem has existed in the group for some time.



Figure 16-35 At some point, the tip of the claw (the thimble) may break partly away from the rest of the wall and remains attached only by sensitive tissue. (Courtesy of J Malmo)



Figure 16-37 The distance between a groove and the hair line is measured at the dorsal flexure of the wall from the groove to the hair line.



**Figures 16-38, 16-39 & 16-40** These three pictures were typical of the appearance of all the claws of cows in one dairy herd. This phenomenon may be referred to as a reaction ridge or band. These pictures were all taken on the same date. The position of the ridge indicated that an insult had occurred when the herd had been removed from very poor pasture. They had been suddenly introduced to silage and a high-production ration. Clearly, there were changes in the appearance of the wall that occurred at the same time but the quality of the reaction was not identical in every cow.



**Figure 16-41** At the same time that the animal's claws seen in Figures 16-38–16-40 were trimmed, hemorrhages in the soles were seen for the first time in some of the cows.



**Figure 16-42** In the same herd sole ulcer-like lesions were observed. In this case a double sole can be seen around the white line and heel region.

**Cause**

A horizontal groove or any other of its various forms is caused by an interference with claw wall horn production. This short-term disruption in horn production can vary in degrees of severity. To complicate this issue, there is considerable variation between animals in the degree to which they can adapt to the cause of the disruption. The mechanical strength of the claw capsule is influenced by changes in its shape and the degree to which the dorsal wall increases in concavity around hardship grooves. Neglected, overgrown claws (as they increase in length) will experience increases in pressure beneath the toe and this results in greater tension on the 'instep.'

See Figures 16-37–16-43.

**Treatment**

With the exception of thimbles, treatment is inappropriate. Thimbles are extremely painful, therefore, animals react violently when they are removed. If this procedure is attempted, the animal should first be sedated. With dairy cows, the foot to be treated should be placed on a piece of wood about 12ins square. Lifting the other limb will fix the limb to be treated. The cutting edge of a woodworker's chisel is then inserted into the crack in such a manner that the shaft runs almost parallel to the dorsal wall of the claw. The beveled edge of the blade should face inwards. A quick strike with a hammer will remove the offending horn. Alternatively, the tip of the claw (thimble) can also be removed with hoof cutters when the limb is elevated. This technique is less precise and evokes a very violent reaction on the part of the patient.

**Control**

Unless about 25% of the animals in a herd have grooves or other manifestations related to grooves in one or more claws, control measures are probably not called for. However, if over 25% of a herd has grooves in roughly the same position, then the timing of the insult should be identified. Once the date of the insult has been calculated, the investigator should identify the managerial or nutritional change occurring during the appropriate time frame.

For beef cows being turned out on pasture for the first time in the spring the following recommendations are offered in order to minimize 'pasture shock':

- Avoid turning out cows for the first time in the spring to pastures that are lush grass 7.5–15cm (3–6ins) high.
- Leave long cover on a pasture in fall and graze it first in the spring.

- Avoid including legumes in pastures to be grazed first in the spring.
- Avoid fertilizing pastures to be grazed first in the spring.
- Offer good quality forage during the first 10 days after turn out.

**Corkscrew Claw****Description**

A typical corkscrew claw always affects the outside hind claws and is not usually observed in cows under



Figure 16-43 A double sole such as is illustrated in this photograph was present in the majority of cows in one herd which walked roadways immediately after claw trimming.

3.5 years of age. The deformity has been reported to be present in 3.5% of mature Holstein cows. The abaxial wall grows more rapidly than normal and twists beneath the claw. The wall displaces the sole axially or it may initially cover the sole.

Affected cows walk carrying their limbs further behind than normal. They gradually lose condition as they become less able to compete for available resources.

A similar condition affecting the front medial claw has been described.

See Figures 16-44–16-48.

**Cause**

The cause of a corkscrew claw is unknown, however, there is likely to be a genetic component. Bony deposits (exostoses) are found on the outside aspect of the pedal joint. These periarticular exostoses are located where the lateral abaxial ligament of the joint is located in normal animals. It is, therefore, proposed that strain of the ligament could occur in animals with slightly abnormal limb conformation, particularly if it is forced to place its limbs outwards and backwards to accommodate a very large udder. The fact that bulls rarely show this deformity tends to support this hypothesis.

It is also postulated that the presence of the abnormal bone beneath the coronary dermis stimulates the production of horn at a rate that is more rapid than normal. The pedal bone inside a corkscrew

claw is narrower than normal lengthwise. This abnormality is probably caused by molding under the pressures created inside the claw by the disorder. The plantar plane of the distal interphalangeal joint is rotated by 11° from normal. This is considered to be the result of the disorder rather than its cause. This hypothesis is supported by the observation that traumatic injuries or surgical interventions involving the coronary band sometimes result in the formation of a false corkscrew.

**Treatment**

Once established, a corkscrew claw will require trimming every 3 months if the cow is to remain functionally efficient. Trimming should only be attempted by a skilled operator who will remove the



**Figure 16-44** A true corkscrew claw has a bony swelling palpable beneath the skin/horn junction. This is caused by the presence of periarticular exostoses which presumably press on the living epidermis and stimulate accelerated growth of the abaxial wall.



**Figure 16-45** Again note the swelling of the bony exostosis above the coronary band of the affected claw. Eventually the wall grows under the claw displacing the sole abaxially. (Courtesy of C Bergsten)



**Figure 16-46** The cow with a corkscrew claw is forced to walk on the wall of the claw. The true sole is displaced axially. (Courtesy of C K W Mülling)

exceptionally hard wall from beneath the claw. Often some degree of white line degeneration shows in the form of hemorrhagic horn. Bleeding in this area can be avoided by leaving the tip of the claw thicker than the normal. Sometimes a white line abscess, with total under-running of the sole together with the risk of bone infection, can develop after a routine claw trimming procedure.

The condition is irreversible, and affected animals must be culled at the end of a current lactation.



**Figure 16-47** The white line at the apex of the claw has started to split open. More horn needs to be removed in which case there is likely to be some bleeding. It is never possible to restore the shape to normal. (Courtesy of C K W Mülling)

### Control

#### KEY CONCEPT

- When bulls are selected for breeding purposes, the female relatives should be examined for evidence of corkscrew claw. If the lesion is found in female relatives, the males should be disqualified from the breeding program. The claw horn of bulls grows slowly, so mature animals may not show definite signs of the lesion.



**Figure 16-48** Some other claw shapes may resemble the corkscrew but lack the bony swelling beneath the hairline. This, probably genetic, abnormality can be referred to as a rolled claw.

Bulls do not show this disorder to the degree seen in cows. Nevertheless, some bulls have hind lateral claws with an axial surface markedly more concave than the surface of the medial hind claw. Animals with this defect should not be used for breeding purposes.

## BIBLIOGRAPHY

- Bouckaert J, Oyaert W, Deloddere E 1956 The corkscrew claw. *Vlamms Diergenist Tijdschrift* 27:149
- Campbell J, Greenough P R, Petrie L 1996 The effect of biotin on sandcracks in beef cattle. *Proceedings of the 9th*

- International Symposium on Disorders of the Ruminant Digit, Jerusalem, p 29
- Envoldsen C, Grohn Y T, Thyssen I 1991 Heel erosion and other interdigital disorders in dairy cows: associated with season, cow characteristics, disease and production. *Journal of Dairy Science* 74:1299–1309
- Glicken A, Kendrick J W 1977 Hoof overgrowth in Holstein-Friesian dairy cattle. *Journal of Heredity* 68:386–390
- Goonewardene L A, Hand R K 1995 A study of hoof cracks in grazing cows – association with age, weight and fatness. *Canadian Journal of Animal Science* 75:25–29
- Greenough P R 1985 Sandcracks in beef cattle. *Bovine Practitioner* 20:44
- Greenough P R 2001 Sand cracks, horizontal fissures and other considerations. *Veterinary Clinics of North America* 17(1):93–110
- Greenough P R 1962 Observations on some of the diseases of the bovine foot. Part I & II. *Veterinary Record* 74:53–63
- Hahn M V, McDaniel B T, Wilk J C 1986 Rates of hoof growth and wear in Holstein cattle. *Journal of Dairy Science* 69:2148–2156
- Hand R K, Goonewardene L A, Yaremco B J, Westra R 1992 A study of the prevalence of cracked claws among beef cows. *Canadian Journal of Animal Science* 72:165–168
- Petrie L, Campbell J, Schumann F 1998 The prevalence of sand cracks (vertical fissures) in the Saskatchewan beef cow herd. *Proceedings of the X International Symposium on Disorders of Ruminant Digit, Switzerland*, p 139–140
- Peterse D J 1980 A bent medial claw. *Proceedings of the III International Symposium on Disorders of the Ruminant Digit, Vienna*, p 122–125
- Prentice D E 1973 Growth and wear rates of hoof-horn in Ayrshire cattle. *Research in Veterinary Science* 14:285–287
- Scott T D, Naylor J M, Greenough P R 1999 A simple formula for predicting claw volume of cattle. *Veterinary Journal* 158:190–195
- Van Schaik P 1952 A gradually increasing defect in black and white cattle. *Tijdschrift Diergenesk* 70:908
- Van Schaik P 1956 Defects of the hind hooves and hind limbs of Dutch Friesian cattle. *Tijdschrift Diergenesk* 81:624
- Wheeler J L, Bennet J W, Hutchinson J C D 1972 Effect of ambient temperature and day length on hoof growth in sheep. *Journal of Agricultural Science* 79: 91–97
- Westra R 1981 Hoof problems in cattle. Is there a relationship with trace mineral levels? *Proceedings of the 2nd Western Nutrition Conference, Edmonton, Alberta*, p 115–132



# Applied Anatomy and Simple Surgical Procedures

## APPLIED ANATOMY

### GLOSSARY

**Foot:** Strictly speaking, the word foot describes the region from the hock to the apex of the claw. In this book the word 'foot' will describe the digital region distal to the fetlock.

**Claw:** The word 'claw' is used to define the organ at the end of the digit of cattle, i.e., capsule and contents. The same structure in the horse is referred to as the 'hoof.'

**Claw Capsule (*Capsula Ungulae*):** The capsule is the structure composed of horn into which the pedal bone and other tissue fit. It has sometimes been referred to as the 'shoe.'

**Cannon Bone:** The bone between the hock and the fetlock (metatarsal) or the knee and the fetlock (metacarpal).

**Axial Surface:** The surface of the claw facing the space between the claws (interdigital space).

**Abaxial Surface:** The surface of the claw facing away (outside wall) from the space between the claws (interdigital space).

**Dorsal Surface:** The front of the claw and limb up to the knee or hock.

**Flexor Surface:** The back of the limb up to the knee or hock. (This avoids using volar/palmar/plantar when a reference is common to fore- or hindlimb.)

**Dorsal Flexure:** This marks the transition from the axial to abaxial wall.

**Solear Surface:** This refers to the sole of the claw. On this surface it is permissible to use anterior and posterior.

**Medial:** The surface or part of the body located towards the midline of the animal.

**Lateral:** The surface or part of the body located away from the midline of the animal.

**Distal:** A part of a limb furthest away from the body.

**Proximal:** A part of the limb closest to the body.

**Dew Claws:** Miniature editions of the main claws, similarly constructed, attached to the digital skeleton by connective tissue and ligaments. They contain remnants of digits two and five respectively.

**Interdigital Space (Cleft):** The space between the two digits, the proximal surface of which is covered by hairless skin.

**Wall:** The wall is referred to in anatomical terminology as the 'coronary segment' of the claw.

**Exostosis (plural, Exostoses):** A bony growth protruding from the surface of a bone.

**KEY CONCEPTS**

- Form and function are beautifully married in the bovine foot.
- About 60% of body weight is born by the forelimbs and 40% by the hindlimbs.

**The Supporting Structures**

**Two Digits each with Three Phalanges**

See Figures 17-1, 17-2 and 17-3.

**Joints: The Pedal Joint (Distal Interphalangeal Joint, DIP Joint, Coffin Joint)**

The anatomical features of the pedal bone are clinically significant from a number of points of view.

The highest point of the bone is the extensor process which protects the dorsal aspect of the joint. The dorsal pouch of the joint is vulnerable both abaxially and axially to this process.

Posteriorly, the pedal joint is connected to the navicular bone by a stout ligament between the bones (interosseous). The ligament makes it virtually impossible for foreign bodies to enter the joint directly through the sole.

The deep flexor tendon inserts into the posterior aspect of the pedal bone, adding further protection against direct penetration of the joint through the solear surface.

The flexor tubercle or process is located on the posterior axial extremity of the pedal bone. In the lateral claws of the hind feet, this tubercle is important in the pathogenesis of sole ulcers (see p. 84). Sole ulcers do not normally occur on the medial hind claws as the solear surface of the pedal bone is at a much greater angle to the ground than is the case in the lateral claw.

The solear surface of the pedal bones becomes rough as it ages.

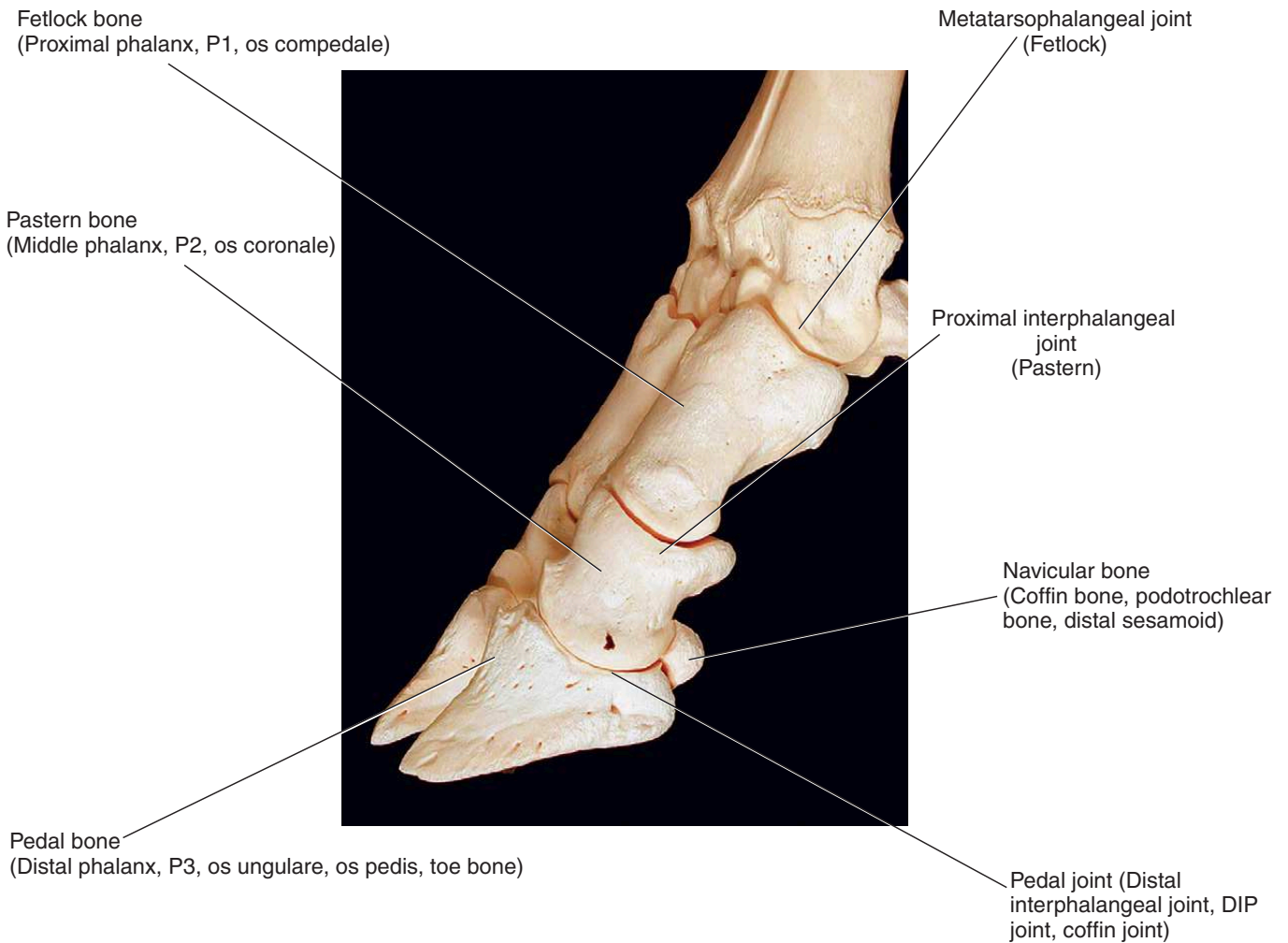


Figure 17-1 The bones of the digital region. (Courtesy of C K W Mülling)



**Figure 17-2** The proximal surface of the pedal joint is concave to receive the distal articular surface of the intermediate phalanx. The dorsal surface of the bone become more convex and rougher as the animal ages due to the drag of the suspensory apparatus of the digit. The concavity of the solear surface impedes the escape of pus from abscesses in this region.



**Figure 17-3** As the animal ages exostoses will form around the flexor process. (Courtesy of Anon)

An abscess involving the white line in zone 3, if not treated early, will extend infection into the navicular bursa which extends right up into the retroarticular recess. See Figures 17-4–17-8.

**Ligaments and Tendons**

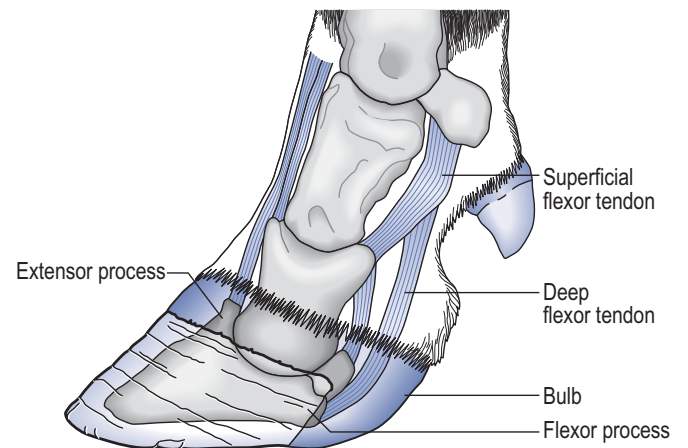
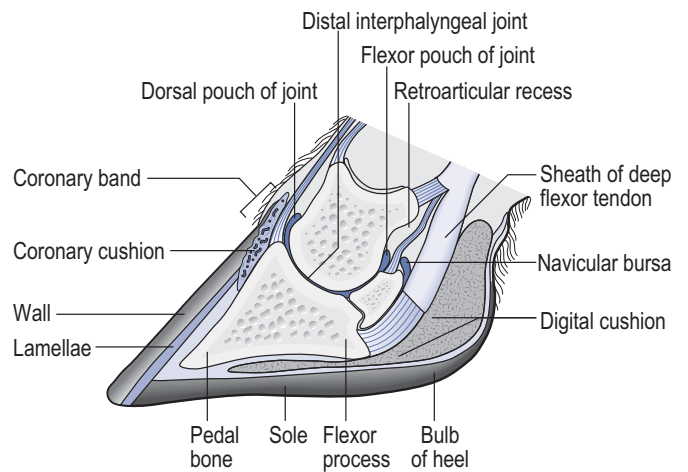
Some of the ligaments and the insertions of tendons associated with the pedal joint are of interest as they play a role in protecting the capsule.

The distal interphalangeal ligament (Figs 17-9 and 17-10) is a much more complex structure than its name implies. Its function is best understood if the structure is considered as being composed as two parts.

**A.** *The Pedal Bone Support System (PBSS).* This term will be used in this book to refer to the fibrous network (or retinaculum) that envelops the digital cushion and deep flexor tendon. The fibers of the PBSS are inserted into the axial and abaxial surfaces of the three bones of the pedal joint. Its function is to control compression of the support system of the pedal bone (p. 20). Vertical pressure is converted into lateral pressure which is absorbed by the walls of the claw. Failure of the PBSS can be implicated in the internal pathogenesis of white line disease.

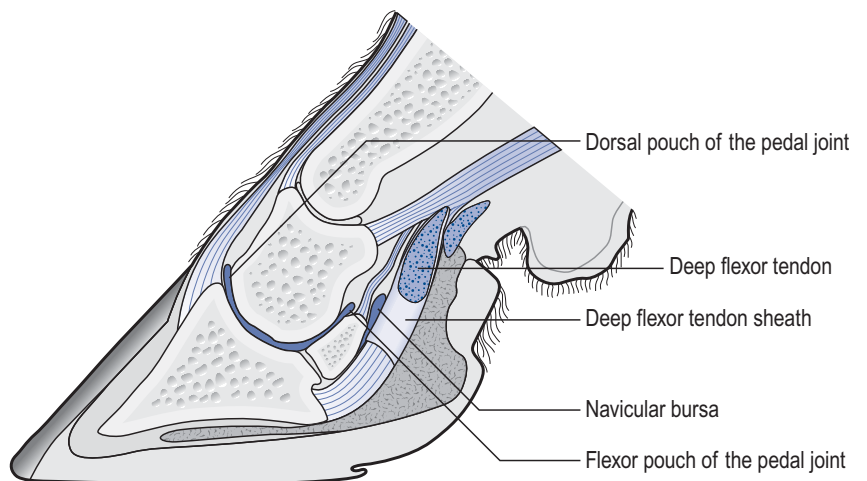


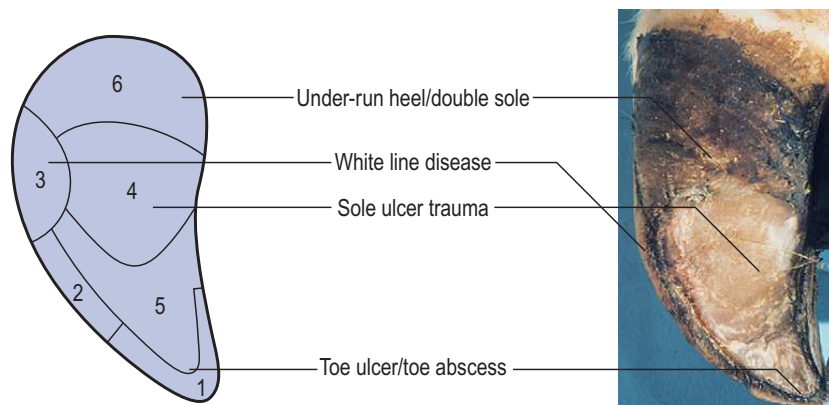
**Figure 17-4** The navicular bursa is located between the navicular bone and the deep flexor tendon. It provides a very easy channel for infection to pass from the region of the white line to the retroarticular space and then on to the pedal joint and/or sheath of the deep flexor tendon.



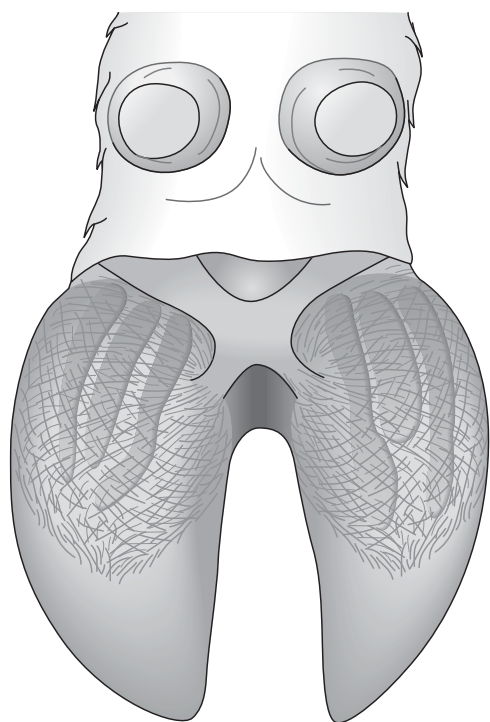
**Figure 17-6 & 17-7** The pedal joint is almost completely enclosed by the claw capsule.

**Figure 17-5** Synovial spaces of the pedal joint which have a role in the pathogenesis of septic pedal arthritis. The dorsal pouch of the pedal joint is vulnerable on either side of the extensor process. The flexor pouch of the joint is located in the retroarticular recess and in close proximity to the navicular bursa and the sheath of the deep flexor tendon.





**Figure 17-8** By international agreement (in identifying the location of a lesion), the claw capsule has been broken up into nine different zones. Typically each zone is associated with one or more lesion.



**Figure 17-9** The distal interphalangeal ligament consists of two functional parts, (see text). (a) The support system of the pedal bone (PBSS) consisting of a retinaculum holding in place the deep flexor tendon and the digital cushion. This 'part' has insertions onto both axial and abaxial surfaces of the bones that make up the pedal joint. Advanced heel erosion can seriously impair the normal function of this complex. (b) The cruciate ligament proper joins the PBSS of each digit. Its function is to prevent the two digits from separating.

- B.** *The Cruciate Ligament.* This ligament merges with the PBSS of each digit as well as the distal annular ligament of the digit. Its function is to control the two claws from spreading apart. It can be seen in Figure 17-10 that this ligament

will be spared to some extent if amputation of the digit is carried out as low as possible on the digit.

The weight of large animals, particularly bulls, can chronically stretch the cruciate ligament. Once this ligament has stretched the skin of the interdigital skin also stretches to permit a fold to form when the foot is not weight-bearing. This flap gradually turns into a fibroma. In these cases, bony filamentous growths (exostoses) are often observed in radiographs at the insertions of this ligament. There are other causes of a fibroma (see p. 273).

The abaxial collateral ligament originates on the abaxial surface of the intermediate phalanx and fans out to insert into the pedal bone. This ligament is subject to stress in some animals and develops bony accumulations (exostoses) around the joint, which in turn press on and stimulate the coronary dermis to produce excessive amounts of wall horn. This explains the cause of corkscrew claw.

The flexor annular ligament of the fetlock supports the proximal sesamoid bones which accommodate the dew claws. The ligament is important as it contains a fibrous plate. This makes it necessary to use an injection site distal to this structure when administering a distal digital nerve block.

The distal and proximal annular ligaments envelop the deep and superficial flexor tendons and the sheath of the deep flexor tendon. An abscess in the retroarticular space can infect the tendon sheath (tenosynovitis; see p. 264). However, because of the restraining effect of the annular ligaments, clinical evidence of this complication is not apparent below the fetlock. Puffiness in the groove on either side of the tendons above the fetlock is indicative of a purulent tenosynovitis that has its origins down in the region of the heel. When opening the sheath to release pus, care must be taken not to cut the vessels and nerves also present in this location.

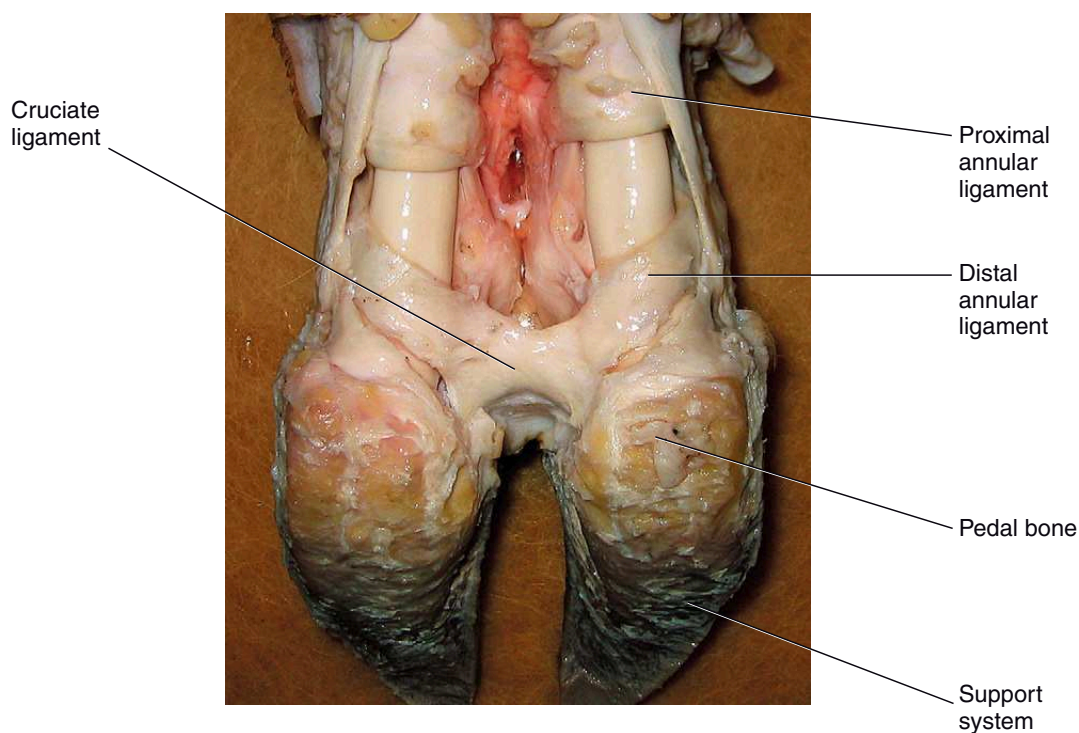


Figure 17-10 A dissection of the distal interphalangeal ligament. (Courtesy of C K W Mülling)

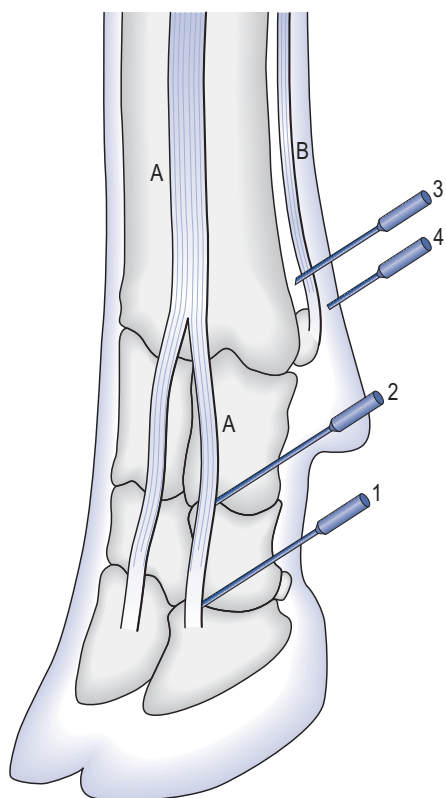
### Arthrocentesis and Arthroscopy

Arthrocentesis and arthroscopy are respectively the introduction of a needle or arthroscope through the joint capsule for diagnostic or therapeutic procedures. Arthroscopy enables the operator to visualize the interior surfaces of a joint for diagnostic purposes or to perform surgical procedures. Arthrocentesis is a procedure by which synovial fluid may be removed from a joint for examination.

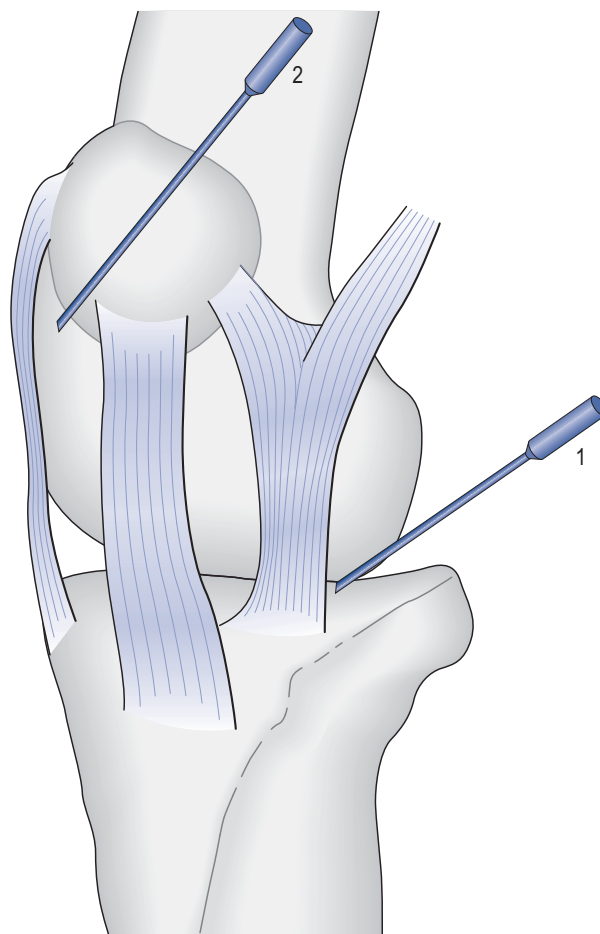
Local anesthetic can be introduced into a joint in order to ascertain if painful lesions are present. Interarticular therapy permits medication to be deposited into the joint.

### Joint Entry Sites

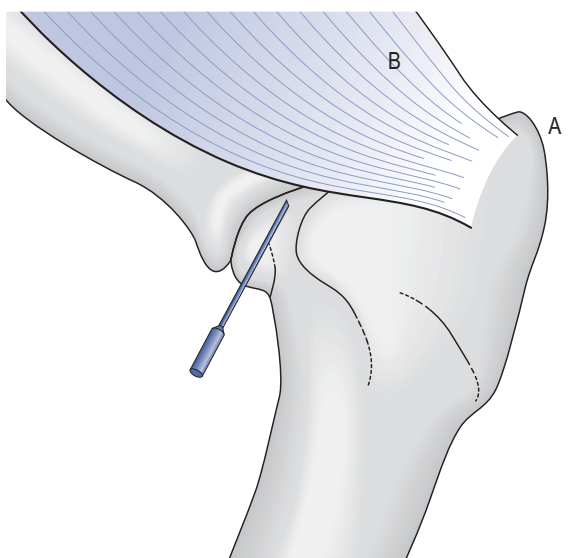
See Figures 17-11 to 17-16.



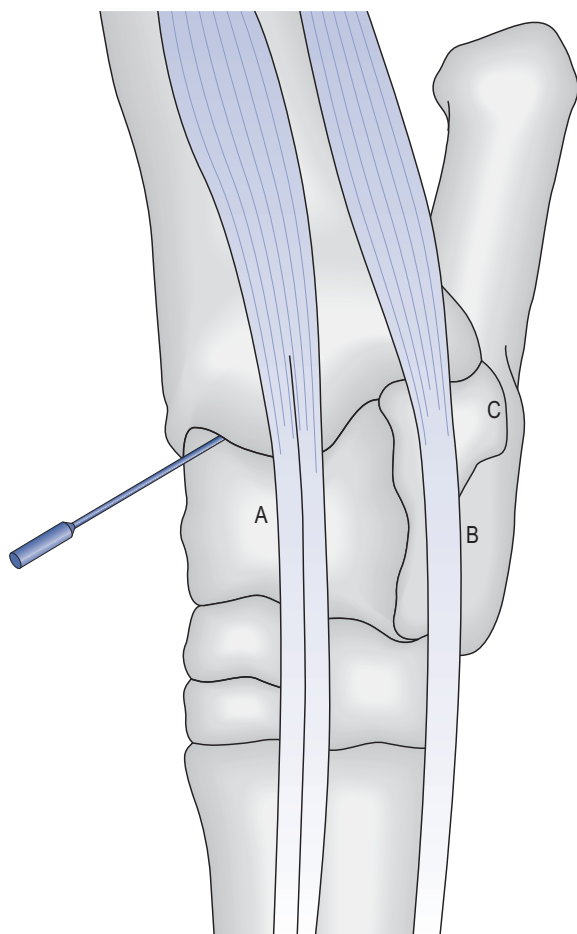
**Figure 17-11 Pedal joint (distal interphalangeal joint or coffin joint).** The needle is inserted abaxial to the common/long extensor tendon which inserts into the extensor process of the distal phalanx. The entry point is just proximal to the coronary band. (Point 1) Pastern joint (proximal interphalangeal). Insert the needle abaxial to the extensor tendon (A). (Point 2) Fetlock Joint (metacarpo/metatarsophalangeal). The needle is directed downwards close to the flexor surface of the metatarsal bone and between it and the interosseous (suspensory) ligament. As this procedure may be painful, a nerve block at a higher level is recommended. The joint can also be entered from the dorsal surface in a similar manner to the distal joints. However, the flexor pouch is larger than the dorsal pouch. (Point 3) Digital synovial sheath (sheath of the deep flexor tendon) (B). The needle is directed downwards behind the interosseous ligament. (Point 4)



**Figure 17-12 The stifle joint.** It is advisable to use two sites as the lateral femorotibial compartment in some animals may not communicate with the rest of the joint. Site One: Close behind the lateral patellar ligament (lateral femorotibial compartment). The needle should be directed caudally. Site Two: The needle is inserted between the medial and middle patellar ligaments and directed slightly down and towards the large medial lip of the trochlea (femoropatellar and medial femorotibial compartments).

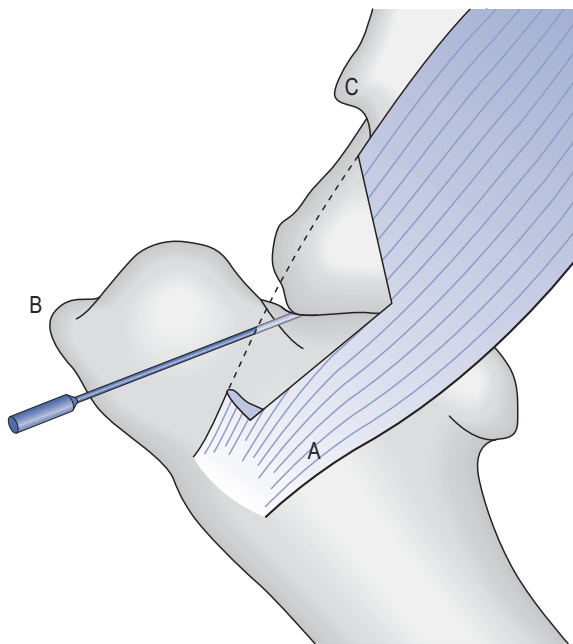


**Figure 17-13** Palpate the prominent trochanter major (A) and the insertion of the middle gluteus (B) onto it. The needle penetrates in front of the trochanter major and just in front of the insertion of the middle gluteus, and is directed caudally and medially.

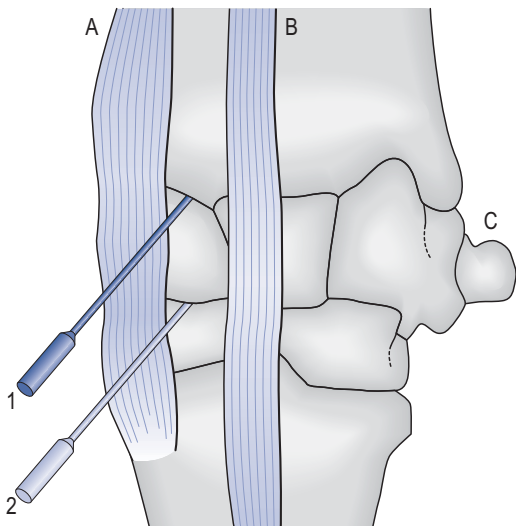


**Figure 17-14** The needle penetrates medial to the extensor tendons. This is the tibiotarsal part of the joint capsule, which communicates with the proximal intertarsal compartment but not with the distal intertarsal or tarsometatarsal compartment. (A) Proper extensor tendon of digit III and long extensor of the digital extensor tendon. (B) Proper extension tendon of digit IV. (C) Lateral malleolus is easily palpated and is used to judge level of penetration.





**Figure 17-15** The needle penetrates just in front of the infraspinous tendon (A) which can be palpated. The major tubercle of the humerus (B) and distal extremity of the scapular spine (C) assist in locating this point.



**Figure 17-16** The radiocarpal part (1) of the joint capsule does not communicate with the intercarpal compartment (2). Some diffusion of the anesthetic may reach the more distal compartments (2). Penetration is easier if the joint is flexed. The needle penetrates lateral to the tendon of the extensor carpi radialis (A) and medial to the combined tendon of the common digital extensor tendon and the proper extensor tendon of the digit (B). Use the proximal border of the accessory carpal bone (C) to judge the level of penetration.

## REGIONAL ANESTHESIA, REGIONAL ANTIBIOTIC PERFUSION, AND NERVE BLOCKS

Most digital surgical procedures can be performed in tranquilized cattle using intravenous regional anesthesia or a nerve block. Nerve blocks are also a very useful diagnostic tool for locating the seat of lameness.

### Regional Anesthesia

#### *Intravenous Regional Analgesia (IVRA)*

This technique is the method of choice of analgesia for most digital surgical procedures. The animal should be sedated and, if possible, turned onto its side. At all events, the limb should be restrained.

One or more gauze rolls (depending on the site and number of veins) placed beneath a tourniquet and directly over the vein to be injected will improve the effectiveness of the technique. Some 10–30mL of lidocaine without epinephrine is usually sufficient to produce analgesia, which develops in about 10 minutes.

When surgery has been completed, the tourniquet is released slowly and then retightened. If antibiotics are to be used, they would be introduced at this point. A few minutes later, the tourniquet is again released. The objective is to release the anesthetic gradually. It is inadvisable to keep a tightened tourniquet in place for more than one hour.

See Figures 17-17 and 17-18.



**Figure 17-17** A tourniquet is applied tightly around the limb within working distance of the surgical site. Palpation of the limb distal to the tourniquet will reveal the presence of enlarged veins. The hair should be clipped from the selected site which is then sterilized. The 20–22-gauge needle is inserted into the vein.



**Figure 17-18** For prolonged procedures, butterfly trocars may be fixed in place with adhesive tape and used at the end of the procedure for antibiotic infusions.

#### *Distal Digital Nerve Blocks*

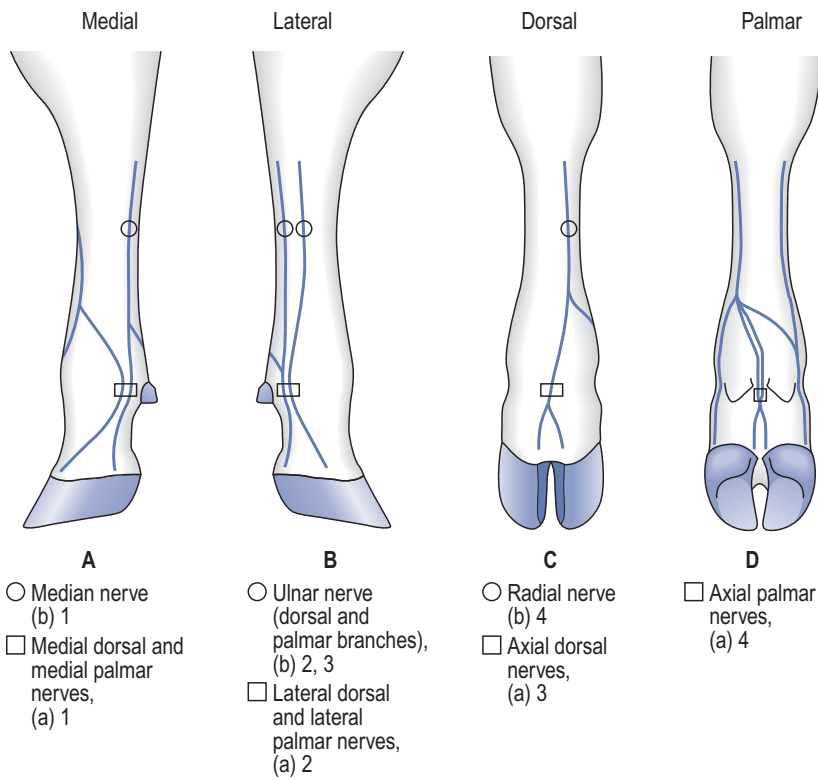
The dorsal site is located on the dorsal axis proximal to interdigital space close to the metacarpal/tarsal-phalangeal joint. Care should be taken in placing the needle in the dorsal site because the proper digital artery can be encountered at this location. Inject 10mL of 2% lidocaine with an 18–20-ga (1-mm diameter) 10-cm needle. If the needle is inserted deep into the interdigital space, the nerves of the flexor surface can be reached. This obviates the necessity of a flexor site block for simple procedures.

The distribution of the nerve supply to the axial face of the digits of the forelimb is not constant. This makes this technique unreliable for digital analgesia of the forelimb. The flexor site that is preferred is a little lower than the dorsal counterpart because it is difficult to pass a needle through the partially cartilaginous palmar/plantar ligament. Inject 5–8mL of 2% lidocaine with an 18–20-ga (1-mm diameter) 5-cm needle.

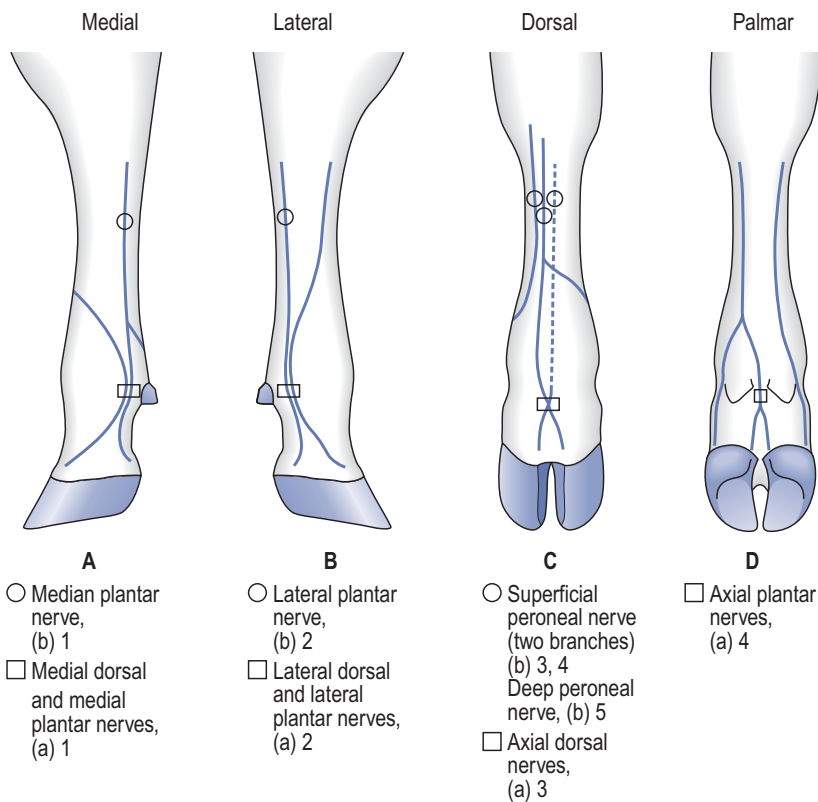
The medial and lateral sites are located at the level of the dew claws. A subcutaneous track of 5–8mL of 2% lidocaine is injected with a 18–20-ga (1-mm diameter) 7–10-cm needle dorsally (horizontal in the standing animal) from a point 2.5cm slightly proximal to the dew claws.

For surgery of the digit, such as amputation, the dorsal, palmar/plantar, and medial or lateral sites are used depending on the claw requiring the intervention. For interdigital surgery (e.g., removal of corns), both the dorsal and palmar/plantar sites are used.

See Figures 17-19 and 17-20.



**Figure 17-19** The sites for analgesia injection of the forelimb.



**Figure 17-20** The sites for analgesia injection of the hindlimb.

## Regional Intravenous Antibiotic Perfusion

This technique may be useful in cases in which it is unlikely that the infected tissues of the digital region will respond to topical and systemic treatment with antibiotics. Antibiotics can also be used concurrently with regional intravenous analgesia.

## DIAGNOSIS AND TREATMENT OF INFECTION OF THE PEDAL JOINT

### GLOSSARY

**Arthrodesis:** An arthrodesis of a joint is created by removing the articular surfaces and securing bone union.

### KEY CONCEPT

- If treatment of an obviously infected digit (e.g., foot rot) does not respond to treatment within 48 hours complications such as joint infection must be suspected. The diagnosis must be re-evaluated, appropriateness of treatment reviewed, and surgical intervention considered at this time. Delay decreases the chance of success.

## Description

Infection of the pedal joint is the most common complication of diseases affecting the distal region of the digits. The condition is a complication of disorders such as sandcrack, white line disease, and foot rot. It is the most painful and stressful condition affecting cattle.

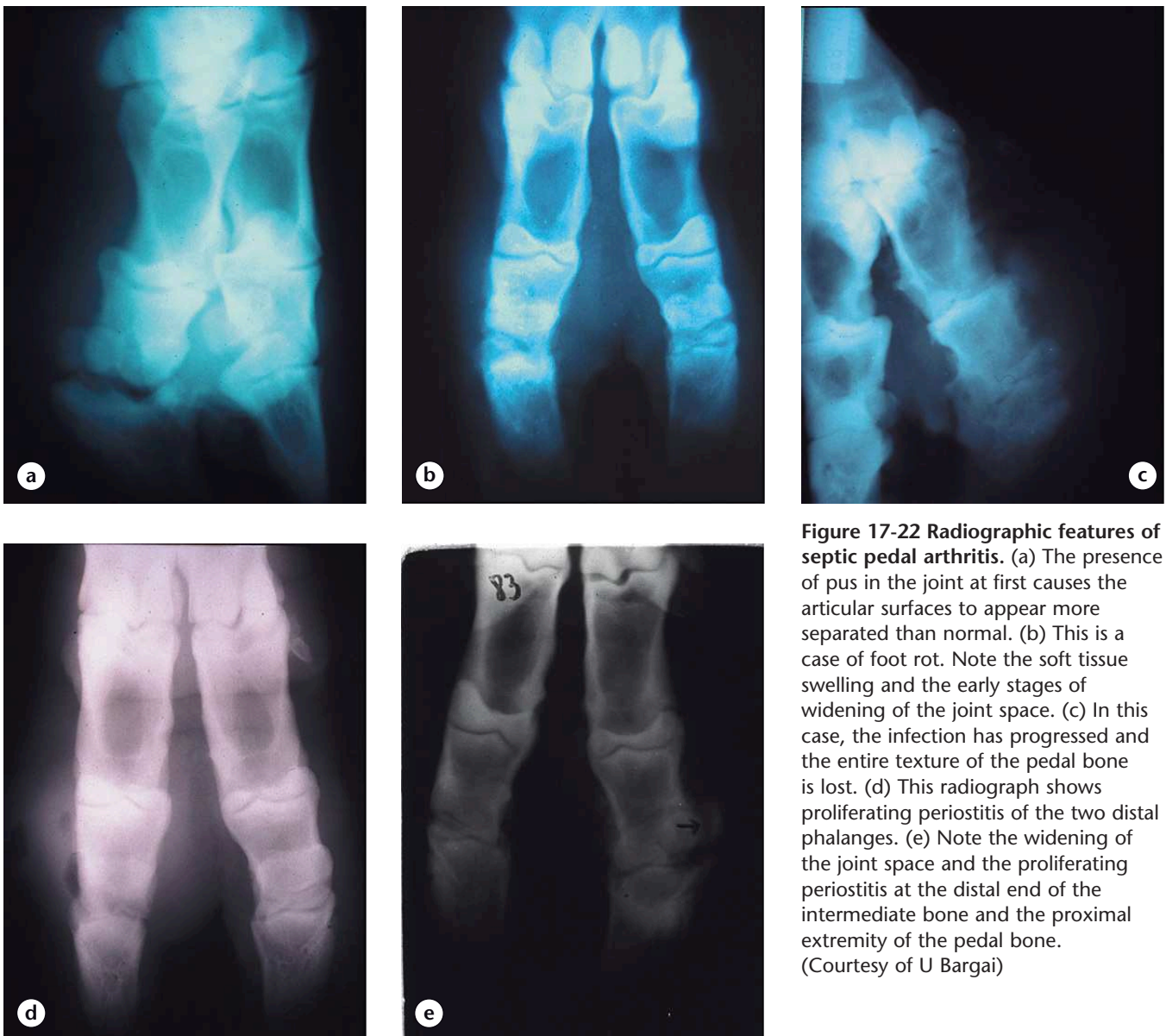
Far too frequently a septic pedal joint is allowed to remain untreated until there is considerable destruction of bone and tendon. This often happens when a producer believes 'a resistant case of foot rot' is being treated. These advanced cases can sometimes be treated successfully, but the surgical procedure is more complicated and expensive.

An animal with acute septic pedal arthritis will be markedly lame. The tissues above the coronary band will be swollen, pink in color, and tender to the touch. In some cases, the body temperature may be elevated and there may be alterations in the blood picture. Radiography can confirm the diagnosis but should be unnecessary. See Figures 17-21 and 17-22.

Septic pedal arthritis will not resolve naturally without causing tissue destruction leading to an extended period of suffering, loss of joint function, and disfiguring deformity. The reason for this is that pus inside the joint cannot find an easy means of escape. The majority of the joint capsule is buried inside the claw, and the exposed areas of the joint cavity are tightly bound up by ligaments and tendons. The rationale for surgery, therefore, is to either remove the diseased joint or devise a means of providing excellent drainage.



**Figure 17-21** The gross appearance of the region will be that of swelling and redness of the coronary band, particularly towards the front. (Courtesy of K Mueller)



**Figure 17-22 Radiographic features of septic pedal arthritis.** (a) The presence of pus in the joint at first causes the articular surfaces to appear more separated than normal. (b) This is a case of foot rot. Note the soft tissue swelling and the early stages of widening of the joint space. (c) In this case, the infection has progressed and the entire texture of the pedal bone is lost. (d) This radiograph shows proliferating periostitis of the two distal phalanges. (e) Note the widening of the joint space and the proliferating periostitis at the distal end of the intermediate bone and the proximal extremity of the pedal bone. (Courtesy of U Bargai)

## Options for treatment

### No action

A producer may elect not to treat an animal with septic pedal arthritis. Most animals will recover eventually, but will likely have a club foot for the remainder of their lives. This is an inhumane option as the affected animal will suffer for months.

See Figure 17-23.

### Amputation of the Digit

Digital amputation provides rapid relief, is inexpensive, relatively easy to perform, and usually enables the resumption of lactation within a few weeks. However, the functional life of the animal is considerably reduced. It has been found that after amputation over 80% of animals will be culled within one year of surgery.

Bulls having seriously complicated lesions in the distal region of the hindlimb are not good candidates for amputation as the remaining digit will not tolerate the mechanical stresses associated with natural service. Only valuable animals that are to be retained for a limited period for purposes of electro-ejaculation should be considered as candidates for amputation. Bulls suffering from acute or prolonged digital pain are likely to have reduced fertility.

If amputation of the digit is carried out promptly after the first signs of septic pedal arthritis are present, there



**Figure 17-23** Untreated, septic pedal arthritis causes severe tissue damage and the deposition of large amounts of periarticular bone. This can be referred to as 'club' or 'bumble' foot.

is a good chance of minimal postoperative pain. Consequently, the milk yield will be less affected. However, any cow that has undergone such invasive surgery will suffer some postoperative discomfort. If this occurs near peak lactation, there will be a significant drop in milk production, the level of which will not be restored during that lactation. If the cow is several years old and/or not a high producer, it may be prudent to cull rather than treat the animal.

### Technique

There is some difference of opinion among surgeons regarding the level at which a digit should be removed. The method described here is the quickest, easiest, and least subject to complications.

In the unlikely case that systemic antibiotics have not been used in the initial treatment of the case, the systemic use of one of these products should be considered.

The animal should be tranquilized and the limb elevated. If the animal struggles excessively, the dose of tranquilizer should be increased and the animal cast and turned on to its side while keeping the head elevated (to prevent the regurgitation of rumen contents). The whole digital region should be cleansed and the site of the incision shaved. A tourniquet is applied around the metatarsus/carpus and intravenous regional analgesia should be administered. The surgical site should then be sterilized.

An incision should be made right down to the bone, completely around the digit about 1cm above the hair line. This incision guides the fetotomy wire which otherwise will take an irregular path leaving some horn-producing dermis. The pedal bone and a small amount of the intermediate digit are removed with fetotomy wire. The tourniquet is gradually released. Vessels in the skin may be ligated. However, hemorrhage is usually not a problem and can be controlled with a pressure bandage if properly applied. The wound should be dressed with a bacteriostatic powder, covered with gauze and cotton batten, and bandaged.

There are several arguments to justify this method:

- The cruciate ligament receives minimal damage.
- The preliminary circumferential incision in the skin guides the wire and eliminates ragged edges to the wound. This incision ensures that all of the horn-producing tissues have been removed, avoiding the re-growth of unsightly fragments of horn.
- The distal end of the deep flexor tendon sheath is opened to permit drainage.

See Figures 17-23 and 17-24.



**Figure 17-24** An incision should be made down to the bone following a line 1cm proximal to the skin/horn junction. A fetotomy wire is inserted between the claws and looped around the affected digit. Placing the wire into the prepared cut has two advantages. The wire cuts bone and is less lubricated by blood. Secondly, if the wire cuts the skin the edge of the wound will be ragged. In this case, a regional nerve block had been applied. With no sensation in the foot, the animal placed its full weight on the digit in order to rest the sound limb. Having the foot fixed in this way makes amputation very easy in a standing animal.



**Figure 17-25** For the first step in protecting the stump of an amputated digit a bandage is wound around the pastern. Next a gauze pad with an antibiotic dress is placed over the wound. Then a loose roll of bandage is placed over the gauze in order to control hemorrhage. Tight winds around and over the wound apply pressure. The wind continues back around the pastern. This provides sufficient pressure to control bleeding.

### **Arthrodesis of the Pedal Joint**

#### **Arthrodesis by Direct Ablation of the Joint**

Arthrodesis is the process by which the pedal bone and the intermediate phalanx are fused. The wound produced provides excellent drainage for infection. The technique has proven to be successful even in heavy bulls. However, not only in bulls but any other subject successful arthrodesis depends very much on early diagnosis and surgery. This surgery is expensive for the farmer. The procedure is followed by several weeks of discomfort for the patient; therefore, milk production for the remainder of a lactation is likely to be lost. However, there is a good prospect that the animal will eventually be able to walk normally and resume a productive life.

#### **Technique**

The digital region is prepared in exactly the same manner as for amputation. The procedure is shown in Figures 17-26–17-29. A veterinary surgeon performing this procedure for the first time is well advised to practice on a cadaver as it is extremely difficult to be certain of directing the drill in such a manner that it will pass through the joint.

The digital region and fetlock must be further immobilized in water-activated fiberglass. Methyl methacrylate should be applied to any part of the case touching the ground as fiberglass will not tolerate abrasive surfaces. The animal will remain in discomfort for several weeks, but recovery to full functional use of the limb can be expected provided surgery is not delayed.

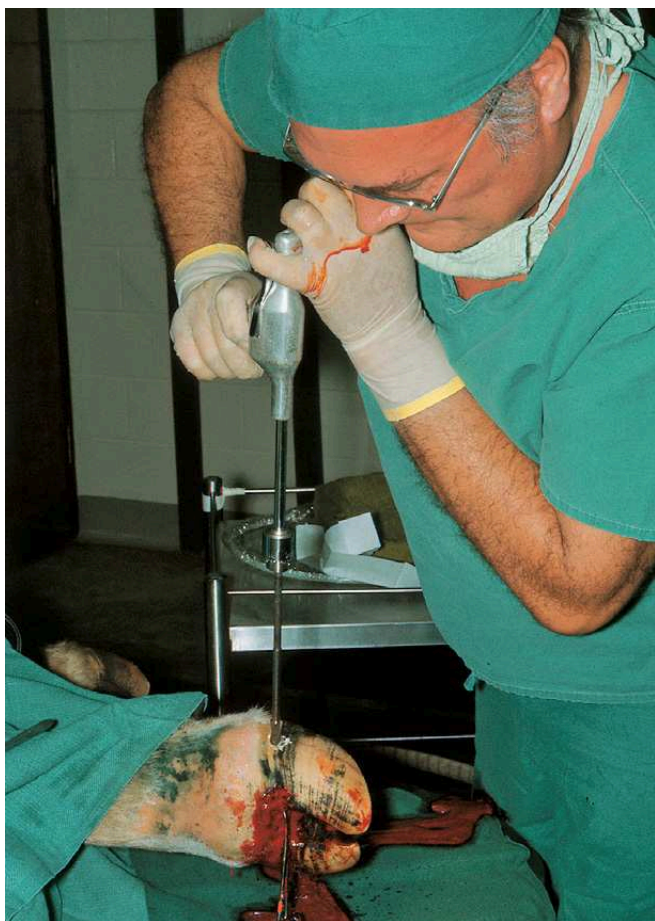


Figure 17-26 The joint is entered through a hole at least 1.5cm in diameter drilled through the posterior third of the abaxial wall about 2.5cm below the hair line. The canal is drilled through the joint in a direction such that it will exit in the axial space 2.0cm axial to the extensor process.

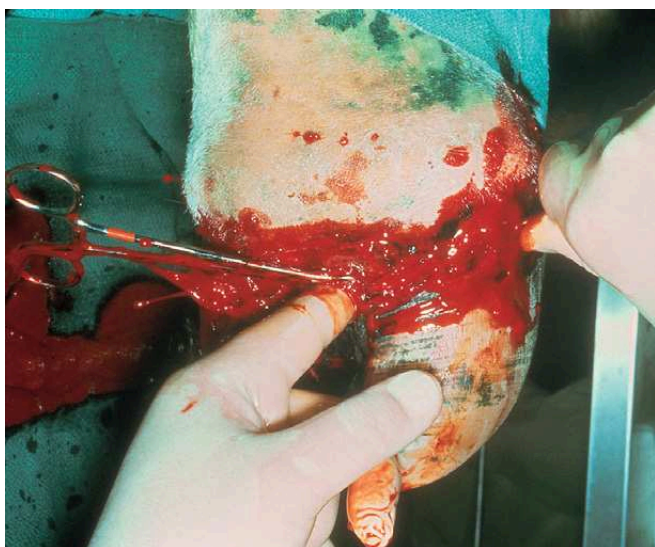


Figure 17-27 A curette is inserted into the canal produced by the drill. The cartilage of the joint is carefully removed from both ends of the canal.



Figure 17-28 An irrigation tube is then inserted from the opening on the axial surface of the claw and is fixed at the point of exit on the axial surface of the hoof.



Figure 17-29 The drainage tube is strapped to the leg and the joint is irrigated continuously (approximately 20L/day) with sterile physiological saline solution for two days. At the end of this period, a block is affixed to the sound claw. The affected digit is then immobilized to the sound claw with wire and acrylic.





Figure 17-30 This radiograph was taken when a lame heifer was first presented. There is considerable soft tissue reaction and the beginning of deterioration of the joint.



Figure 17-31 The second radiograph was taken of the same heifer shown in Figure 17-30 17 days later when the client had eventually elected for surgical intervention. This demonstrates the rapidity with which a neglected case of pedal arthritis can progress.

### Arthrodesis by Resecting the Deep Flexor Tendon and Removing the Navicular Bone

This approach to arthrodesis is appropriate when septic joint disease has progressed to the point at which there is necrosis of the bone and tendon. Unless this dead tissue is removed, the wound will never heal, and the animal will be left in considerable pain. Extreme changes in the bone can be seen in radiographs such as Figures 17-30 and 17-31.

There are two different approaches to resection.

- A. *The longitudinal approach* (Fig. 17-32). This is a traditional approach commonly used in Europe. An incision is made from a point just distal to the dew claws down and into the center of the heel bulb. This approach cuts the annular ligaments and reduces the stability of the digit.
- B. *The horizontal approach*. This approach permits necrotic tissues to be removed without invading the tendon sheath or the annular ligaments and

does minimal damage to the cruciate ligament. The horizontal technique permits the navicular bone to be completely exposed. This is very important as the navicular bone is often necrotic and is always very difficult to remove. It should be noted that the sheath is not present beyond a point corresponding with the center of the intermediate phalanx.

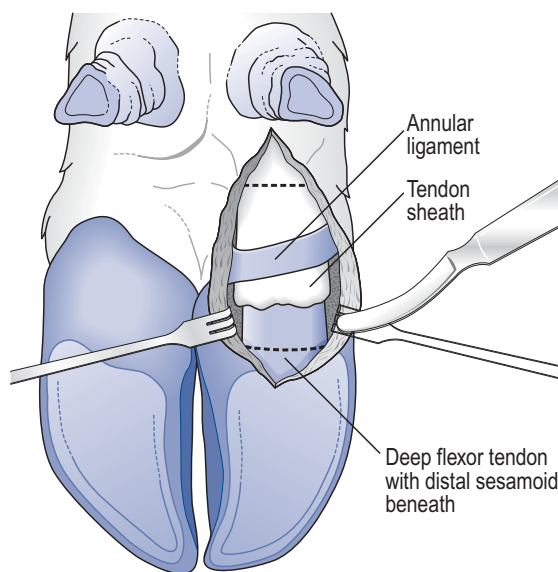
### Technique

The operation site is prepared and anesthetized as for other digital surgeries. An incision is made around the heel, 1 cm proximal to the hair line, from axial groove to abaxial groove. The cut is made right down to the bone. An inverted wedge of tendon and digital cushions is removed. The claw is hyperextended until the whole of

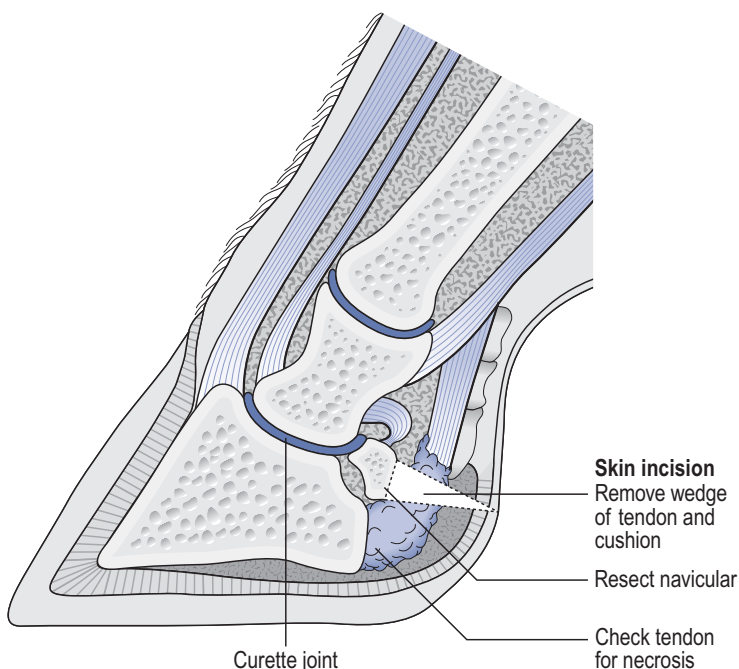
the navicular bone is exposed (see Figs 17-33, 17-34, 17-35). It is impossible to remove the navicular bone (without causing unnecessary damage) by cutting ligaments with a knife. The quickest and easiest method is to use a large, coarse burr. Necrotic cartilage from the joint is removed at the same time and a hard walled 0.3cm drainage tube passed through the joint and out through the skin on the front of the digit. The wound is sutured.

A lift should be applied to the normal claw and the two digits bridged together with wire and methyl methacrylate (see p. 268). The wound should be irrigated continuously for two days with sterile normal saline. The drainage tube may be left in place but the whole digit should be encased in fiberglass. A window may be left in the cast to permit inspection of the drainage tube protruding from the rear of the foot. The window should be closed between inspections with adhesive tape. The plaster should be left in place for a month provided there is no evidence of increasing discomfort.

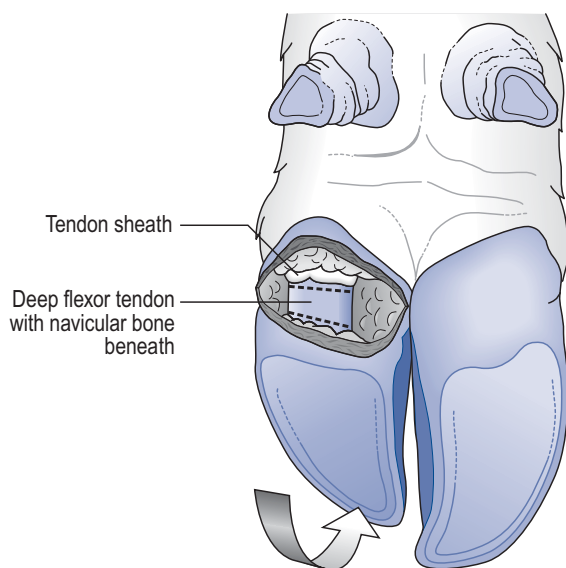
See Figures 17-32 to 17-42.



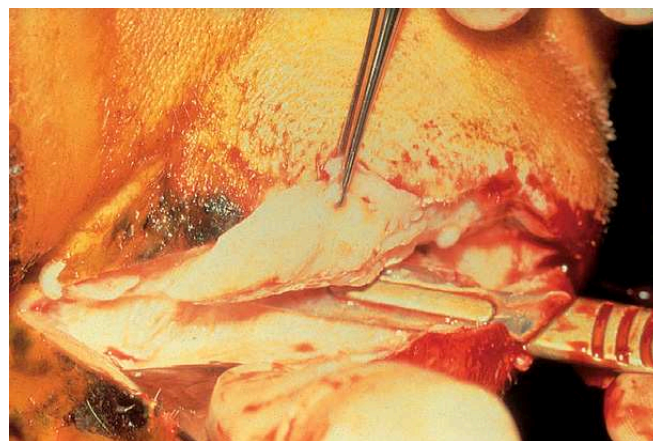
**Figure 17-32** The traditional longitudinal technique is to expose the flexor structure with an incision running from just below the dew claw into the centre of the heel bulb. This technique causes unnecessary damage to the annular and cruciate ligaments.



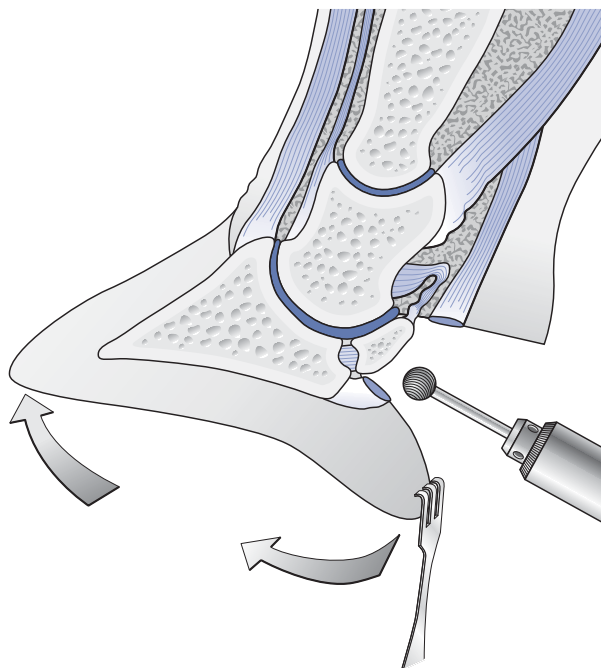
**Figure 17-33** This is a diagrammatic representation of how an inverted wedge of digital cushion and deep flexor tendon is removed.



**Figure 17-34** The incision and removal of a block of digital cushion exposes the deep flexor tendon which is resected to expose the navicular bone.



**Figure 17-36** The first incision is made around and 0.5cm beneath the hairline of the heel bulb. The cut is extended down to the bone and right through the flexor tendon. A second cut is made through the same incision. The objective is to remove part of the digital cushion and deep flexor tendon in order to completely expose the navicular bone. In this way the skin is saved while access to the joint is improved.



**Figure 17-35** At this point, forced upward traction on the toe will cause the wound to gape open and permit better visualization of the navicular bone and potential areas of tendon necrosis. A burr is the most effective instrument with which to excise a necrotic bone.



**Figure 17-37** Resection of the deep flexor tendon provides excellent visualization of the navicular bone. These are fragments of the navicular bone excised through a horizontal incision.



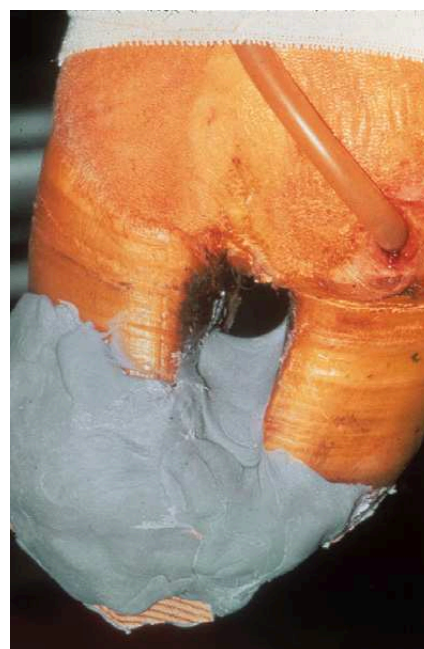
**Figure 17-38** The incision is made down to the navicular bone severing the deep flexor tendon. The navicular bone is removed with a burr. A drainage tube is drawn through the joint, emerging on the dorsal surface of the digit. Holes are cut in the portion of the tube that will lie within the wound. The end of the tube is folded over on itself and secured with a ligature.



**Figure 17-39** The wound is sutured closed.



**Figure 17-40** A lift is fixed to the sound claw. Wire is passed through a hole in the lift to another in the apex of the sound claw. The arrangement should hold the affected claw in a flexed position. The two claws are then further immobilized by a bridge of methyl methacrylate.



**Figure 17-41** The wound is irrigated for four days with sterile saline and then the tube is removed. After one month the joint will have anyklosed sufficiently for the lift to be removed. Immobilization during the healing process reduces postoperative deformity considerably.



**Figure 17-42** One month after surgery the healing process across the space between the two distal phalanges has commenced. This animal showed no signs of lameness three months after surgery.

### **The Solear Approach to Draining the Pedal Joint**

Some workers approach the joint from the center of the sole (with a drill bit 2cm in diameter) from a location in the center of the sole/heel junction. This route passes through the pedal bone and/or the navicular bone. This method is easy to perform and provides excellent drainage and the wound will heal. However, the risk of the wound becoming contaminated is considerable. Care is needed to construct some form of cast which not only immobilizes the joint but also protects the wound from contamination.

## **DIAGNOSIS AND TREATMENT OF STRUCTURES ASSOCIATED WITH THE PEDAL JOINT**

### **Retroarticular Abscess (also see p. 89)**

#### **Description**

The clinical indication of a retroarticular abscess is an enlargement of the area directly above the heel bulb of one claw. The animal will have been lame for some days and/or the animal attendant may report having treated the animal unsuccessfully for foot rot.

Invariably this condition is a complication of white line disease; therefore, the diagnosis of a retroarticular abscess is confirmed if a white line lesion is found in zone 3. A retroarticular abscess progresses quite rapidly to invade the pedal joint, in which case swelling, redness, and tenderness will gradually involve the front of the digital region. Radiographic evaluation is strongly recommended. Gas may be evident in the space behind the intermediate phalanx. This is diagnostic of a retroarticular abscess. A radiograph may also show evidence of severe damage to the pedal joint. Prompt treatment is highly essential if the condition is not to deteriorate.

A retroarticular abscess is under considerable tension. It is surrounded by a thick wall of fibrous and elastic tissue (the retinaculum). Even if there is a small sinus, purulent material is unable to escape as the elastic tissue closes the opening as if it were a valve. The pressure inside the abscess prevents the presence of fluid being detected by palpation. However, the presence of pus can be confirmed by inserting a wide bore hypodermic needle directly into the swelling and withdrawing the contents of the abscess with a syringe.

#### **Differential Diagnosis**

##### **Foot Rot**

This condition is very easily confused with foot rot, but in that disease both digits are involved. Not only is a retroarticular abscess mistaken for foot rot, but a common error is to fail to appreciate that purulent fluid is present at all. Even if an abscess is suspected, its size will be underestimated. In reality, the abscess is frequently the size of a hen's egg and the internal pressure will eventually cause necrosis of the deep flexor tendon and disintegration of the navicular bone (Fig. 17-43).

##### **Septic Arthritis of the Pedal Joint**

When only the joint is involved swelling of the tissues directly adjacent to coronary band is predominant (see Fig. 17-44). If the retroarticular space is involved the swelling also extends up to the fetlock (Fig. 17-44).



**Figure 17-43** This is a view of a retroarticular abscess in the heel bulb of an amputated digit. Note the thick wall of the lesion.

### Technique

Simply lancing the abscess is inappropriate as the yield of pus is minimal. The thick wall of elastic tissues (retinaculum of the PBSS) around the lesion closes a sinus like a valve.

The animal is prepared for surgery and a regional anesthetic administered. The track from the white line starting in zone 3 should be completely exposed by removing the abaxial wall of the claw. An incision is made with the point of a scalpel directly into the abscess. The site of the incision is half way between the hair line and the bearing surface at the junction between the wall and the bulb (abaxial groove).

A hard walled drainage tube (about 1.5cm in external diameter) is then prepared. Several small holes about 0.5cm in diameter are cut into the side of the tube about 5–10cm from its end.

A probe is inserted into the incision and pushed across the abscess until it can be felt beneath the skin or soft horn of the axial surface of the heel bulb. A second incision is then made down onto the probe in order to allow the tip of the instrument to emerge. The free end of the drainage tube is then placed over the end of the probe and drawn into the incision between the bulbs and out through the incision on the abaxial wall. The end of the tube in which the holes have been cut is then closed by folding it over on itself and tying with thick ligature material. The portion of the tube with the holes is drawn into the abscess and held there by restraining it with the free end of the ligature material tied around the claw.

A lift should be applied to the sound claw. The affected claw can be wired to the block and a bridge of methyl methacrylate applied. A bridge will immobilize the digit as a means of aiding the repair process. The lesion should be irrigated with sterile saline for 48 hours by which time the swelling of the heel should have collapsed.

See Figures 17-45 to 17-49.



**Figure 17-44** Edema has spread up to the fetlock in the animal in which the initial lesion was a retroarticular abscess that involved the pedal joint. (Courtesy of K Mueller)



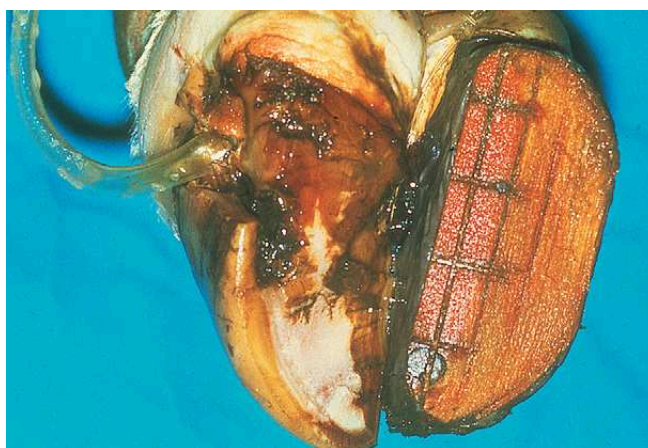
**Figure 17-45** Purulent material can be aspirated from the swelling in some instances.



**Figure 17-46** In most instances, there will be a sinus on the abaxial surface of the claw leading directly into the abscess. This may be located beneath the wall which will be detached and easily removed.



**Figure 17-47** A probe is then inserted into the lesion and the point palpated on the other side of the lesion at a on the axial surface of the bulb. An incision is made down onto the tip of the probe. A drainage tube is slipped over the end of the probe which acts as a guide across the abscess.



**Figure 17-48** The end of the tube is fixed with stout nylon suture material with a loop around the digit. Irrigation with sterile saline for 24 hours will keep the tube clear. However, the tube should be left in place for about three days, after which time a natural drainage opening will have formed.



**Figure 17-49** The flexor tendon of the digit on the left has disintegrated and the claw is hyper extended or 'cocked up.' Although the heel is still swollen and inflamed the lesion is resolving but the claw will remain permanently overgrown at the toe. Resection of the deep flexor tendon could still be attempted at this stage in order to restore the foot to near normal function. (Courtesy of K Mueller)

## SEPTIC TENOSYNOVITIS

### Description

The retroarticular space is a location at which three synovial spaces come into very close contact. They are the plantar pouch of the pedal joint, the navicular bursa, and the sheath of the deep flexor tendon. For this reason, septic tenosynovitis is a complication of septic pedal arthritis or a retroarticular abscess secondary to white line disease.

Clinical evidence of septic tenosynovitis is a soft fluctuating swelling extending about 10cm above the fetlock, filling the grooves on either side of the flexor tendons. Normally no such swelling is evident between the fetlock and the heel bulb because this region is tightly bound by the annular ligaments of the fetlock. Of course, it is highly probable that there will be evidence that septic pedal arthritis or a retroarticular abscess is present at the same time. Samples may be drawn with a needle and syringe from the sheath in the space immediately proximal to the plantar/palmar ligament of the fetlock at a point about 2cm from the midline. Radiographically, gas may sometimes be observed in the sheath.

A tenosynovitis can also be a complication of a sole ulcer if infection has invaded the insertion of the deep flexor tendon. If this complication is suspected, a probe can be inserted into the cavity caused by the ulcer and passed up the sheath to be felt beneath the skin above the fetlock.

### Technique

Treatment for septic arthritis or a retroarticular abscess automatically permits drainage of the flexor sheath and resolution of the problem. Attempts to incise an infected sheath above the fetlock are not advised as blood vessels and nerves are located in the grooves on either side of the flexor tendons and are easily severed.

## FRACTURE OF THE PEDAL BONE

### KEY CONCEPTS

- A true fracture takes place across the posterior third of the pedal bone and involves the joint.
- A so-called 'pathophysiological fracture' involves the anterior mass of the pedal bone and results in detachment of the apex of the bone.

## Traumatic Fractures

Traumatic fracture (Fig. 17-50) is the most painful of all causes of lameness. The onset of the lameness is particularly sudden. The cause is most probably trauma.

### Treatment

The traditional treatment for this condition is to confine the affected animal to an extremely small, well-bedded loose box – movement delays healing. Unfortunately, new bone deposition tends to be excessive, and this interferes with the normal function of the joint. The animal is likely to become a cripple for life.

The rationale for joint immobilization is based on the principle of minimizing the continuous pull of the deep flexor tendon on the fragment of bone to which it is attached. Therefore, the objective is to immobilize the affected digit in a position of extreme flexion relative to the opposite digit. A lift is applied to the sound claw. A loop of wire is passed through the apex of the affected claw. The ends of the wire are passed through the block and the toe forced into maximum flexion. The bridge is reinforced with methyl methacrylate. The apex of the affected digit usually needs to be trimmed down to the level of the block. The restraint needs to be in place for about 4 weeks. The patient dislikes this abnormal posture, but the prognosis for a complete recovery is excellent.

See Figures 17-51 to 17-56.



**Figure 17-50**  
Traumatic fractures of the pedal bone often affecting the medial claw of a forelimb, crossing of the legs is a common sign. (Courtesy of Anon)





Figure 17-51 Fractures most often involve the pedal joint.

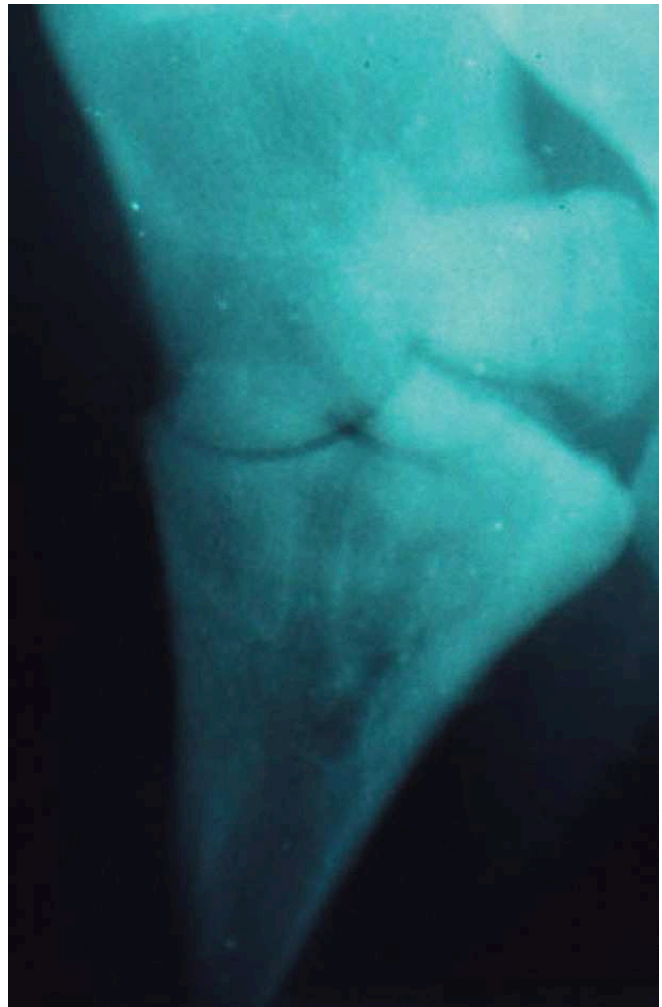


Figure 17-52 A fracture directly into the joint showing how the posterior fragment is pulled by the deep flexor tendon. (Courtesy of U Bargai)

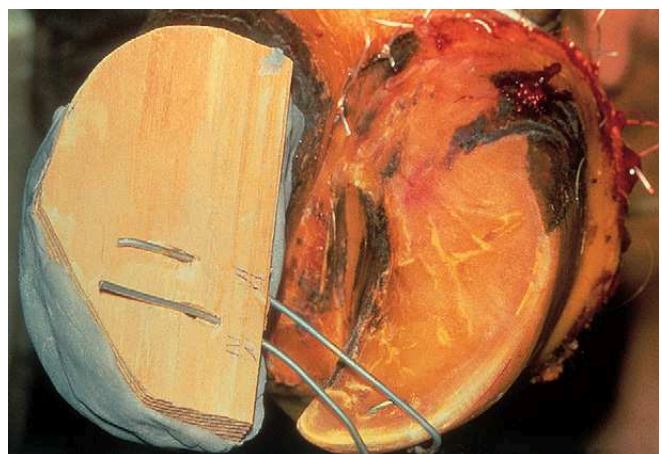


Figure 17-53 A wooden lift is applied to the sound claw. Two holes are drilled in to the apex of the claw and into the block. A wire is threaded from the claw to the block.



Figure 17-54 The affected claw is now forcibly flexed and held in place by the wire.



Figure 17-56 The same animal as in Figure 17-50 after one month of forced immobilization. The fracture has healed with very little new bone encroaching into the joint.



Figure 17-55 The wire is reinforced with a bridge of methyl methacrylate.

### **PATHOPHYSIOLOGICAL FRACTURE OF THE PEDAL BONE**

The following circumstantial evidence can, collectively, increase the probability that a pathophysiological fracture exists:

- The seat of lameness exists in the suspect claw – this finding is confirmed by use of nerve blocks.
- There is no obvious lesion in the claw capsule.
- A radiograph may show a fracture or a fuzzy appearance of the apex of the claw.
- Pain can be generated by the use of calipers on the apex of the claw.
- The animal is recumbent for long periods without obvious cause.

### **Cause**

The cause of this condition is still a matter of speculation and a very difficult lesion to diagnose with any certainty. It is possible that standing for prolonged periods causes reduced blood supply to the pedal bone and that ischemic necrosis follows. It should be noted that the digital artery is quite large and vulnerable to



**Figure 17-57** The opening to the terminal arch. This is a point at which the artery might be vulnerable to increases in intraangular pressure caused by prolonged standing. The terminal arch appears to be the line of demarcation between necrotic and sound bone when a physiopathological fracture occurs. (Courtesy of C K W Mülling)

pressure as it enters the axial aspect of the pedal bone (Fig. 17-57). This artery forms the large terminal arch inside of the bone. It appears that physiological fractures seem to run along the line of this arch.

## Technique

The claw should be anesthetized using a regional nerve block. A tourniquet should not be applied at this stage.

Proceeding with extreme caution, the superficial layers of horn should be removed from beneath the apex of the claw in order to expose the white line. If there is necrotic tissue inside the claw the white line is likely to be black in color. Continue to expose the dermis at the extreme apex of the claw. In positive cases, a black foul-smelling fluid will drain from the wound or shreds of black necrotic tissue can be grasped with forceps. This will confirm the diagnosis. If the wound bleeds profusely, the diagnosis should be re-evaluated. At this point, a tourniquet should be applied and the apex of the claw should be amputated with claw trimming shears. The opening should be adequate to remove a bone fragment.

The cavity should be dressed with antibiotic and packed with sterile gauze and cotton batten. The wound should be wrapped in a waterproof bandage and left for a few days to enable granulation tissue to become established. Ideally, the wound should then be closed with methyl methacrylate.

See Figures 17-58 to 17-62.



**Figure 17-58** Careful examination gradually revealed areas of necrotic dermis and bone in the apex of the claw. (Courtesy of K Mueller)



**Figure 17-59** The apex of the claw was amputated with fetotomy wire and a lift applied to the sound claw. Care must be taken when positioning the wire to avoid cutting through the pedal joint. (Courtesy of K Mueller)



Figure 17-60 The wound is protected from contamination and responds well. (Courtesy of K Mueller)



Figure 17-62 This is the claw of an animal from which the apex has been amputated.



Figure 17-61 This is the fractured apex of a pedal bone removed with necrotic dermis attached.

## OTHER USES FOR METHYL METHACRYLATE

### GLOSSARY

**Exungulation:** This is the removal by accident or surgery of a portion of the claw capsule and exposing the dermis beneath.

**Degloving:** This is the loss of the entire claw capsule either due to trauma or as the result of disease.

**KEY CONCEPTS**

- Accidental or surgical loss of horn capsule will be replaced from the circumference of a wound provided there is a bed of granulation tissue over which it may grow.
- If horn-producing (keratogenic) tissue is exposed, by trauma or surgery, it must be protected from further damage and from drying out. Very slight pressure controls the exuberant production of granulation tissue.
- Methyl methacrylate is inert and a non-irritant to delicate tissues.

**Methyl Methacrylate**

Methyl methacrylate is one of a group of acrylics such as Lucite and Perspex which are polymerized from various chemicals. The two best-known commercial products are marketed under the names of Demotec and Technovit. (Other very similar products are on the market for use as adhesives for lifts but they may be unsuitable for prosthetic purposes.)

Methyl methacrylate is supplied in two parts: an inert polymerized powder containing a catalyst and an unpolymerized liquid. When the two parts are mixed, a heat-generating reaction takes place. Once the substance has cured, it is non-irritating to tissues.

**Examples of the Use of Methyl Methacrylate**

Irrespective of the nature of the exposed dermis or bone, it is advisable to allow time for healthy granulation tissue to invade the site. The length of time needed for this to take place depends on the size of the area of the wound to be covered. Usually, a preparation or preclosure time of from 2–4 days is adequate. Therefore, when the wound is first presented, it should be cleansed and dressed with an antibiotic powder, covered with gauze, and protected with a waterproof elastic bandage. If the wound is heavily contaminated, it may be dressed for 12 hours with an equal mixture of magnesium sulfate and glycerine. This mixture is highly hygroscopic and should not be left in place longer than is essential. Dressings for human use consisting of tulle impregnated with petroleum jelly and antibiotic are easy to use and effective.



**Figure 17-63** An elk with a fractured claw was presented. The damaged claw horn and bone are removed, the wound is dressed with antibiotic, covered with gauze and bandaged.

Once the wound has started to cover over with granulation tissue, a layer of methyl methacrylate can be applied. Horn surfaces around the wound should be roughened to increase adhesion. The product should be mixed and turned out onto a plastic surface. The acrylic is gently applied over the wound. The heat generated during polymerization must be slowed down by running cold water from a hose over the product.

**Fracture of the Claw Capsule and Pedal Bone**

See Figures 17-63, 17-64, and 17-65.



Figure 17-64 The appearance of the damaged surface three days after protective bandaging.



Figure 17-66 Applying methyl methacrylate on a sheet of plastic or via the medium of a plastic glove allows the operator to mold the material more effectively. If bare hands are used, they should be kept wet to prevent the material from sticking to the skin.



Figure 17-65 The protective cap of methyl methacrylate. The elk was released and recovered uneventfully.



Figure 17-67 A pad of acrylic 1.5cm thick will effectively protect a toe ulcer for a sufficiently long period to allow healing. However, care must be taken to ensure that granulation tissue is present before the material is applied. Toe abscesses should not be treated in this manner.

### **Protection of a Toe Ulcer**

See Figures 17-66 and 17-67.

### **Protection of Neglected Trauma to the Claw**

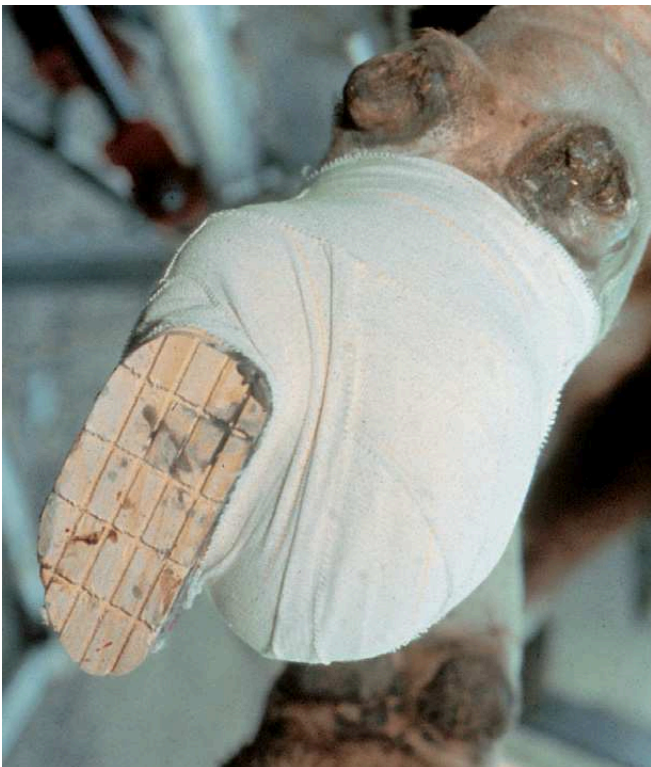
See Figures 17-68, 17-69, and 17-70.



**Figure 17-68** In this case, a fractured claw had been neglected. The animal continuously damaged the wound which bled profusely.



**Figure 17-70** Six weeks after treatment, a thin film of horn had covered what remained of the pedal bone and the animal walked soundly.



**Figure 17-69** A wooden lift was applied, the wound cleansed and protected with a bandage.

## MANAGING A DEGLOVING INJURY

### Description

Loss of the claw capsule occurs sometimes when an animal catches its foot in a mechanical obstruction such as the rails in a gate. The capsule may be completely torn away or remain partially attached to the dermis. Each case will vary and, therefore, each case has to be dealt with innovatively. In principle, the capsule, even if partially detached, provides the best protection to the dermis. Holding the capsule in place is,



Figure 17-71 Partially degloved claws after having been enclosed in a protective bandage for ten days.

if possible, the best approach. There should be no foreign material left between the capsule and the corium.

Cotton batten and a bandage should be applied to the pastern and lower metatarsus/carpus. Fiberglass should then be wound tightly around the two claws and then up and around the previously prepared extremity. The most distal portion of the cast should be covered with methyl methacrylate. Fiberglass will wear through rapidly if the animal attempts to bear weight. It is wise to cover areas subjected to wear with a waterproof bandage or duct tape.

Sometimes both claw capsules are lost from one foot. Even these cases can occasionally be salvaged. The patient must have a tranquil disposition and the damage to the dermis should not be severe. In these cases, the corium should be wrapped in antibiotic-impregnated petroleum jelly tulle and covered with gauze and padding. This should then be wrapped with fiberglass and winding should continue up the previously prepared limb.

See Figures 17-71 and 17-72.



Figure 17-72 An extensively degloved foot after two months of protective plastering.



## INTERDIGITAL HYPERPLASIA (CORNS, FIBROMA)

### Description

An interdigital fibroma is a fold of fibrous tissue hanging down into the interdigital space. Sometimes these abnormalities are so long that they rub on the ground and the skin is eroded away. The incidence in beef bulls has been reported to be 22–25%. Radiographic evidence shows that in a heavy bull with an interdigital fibroma, exostoses form at the insertions of the distal interphalangeal (cruciate) ligament into the axial surfaces of the distal and intermediate phalanges.

See Figures 17-73 and 17-74.



**Figure 17-73** An interdigital fibroma is a fold of skin with a fibrous core located between the digits. As the lesion increases in size, it becomes prone to trauma and ulceration with resultant lameness. (Courtesy of J Ferguson)



**Figure 17-74** Chronic irritation from interdigital dermatitis in combination with slippery floors and damp conditions are the most important contributing causes of 'corns' in dairy cows. Also, a single digit inflammation, as in a severe sole ulcer, can cause a fibroma. In the latter case, the hyperplasia is located at the same side of the interdigital space as the affected digit.

### Cause

There is a hereditary component to the condition which determines the transmission as an inconsistent autosomal dominant pattern. The male progeny of a

beef bull with a fibroma are more likely to be affected than would be normally expected. The higher the butterfat yield of the dam, the higher the risk for a fibroma in male descendants. The heavier the weight of a Holstein-Friesian bull, the greater the frequency of interdigital fibromas.

The hyperplasia is caused by over-tension and slow fibrosis of the subcutis of the interdigital skin. Poor conformation such as splayed digits may be a contributory cause. Inflammation of the skin resulting from interdigital dermatitis (ID) or digital dermatitis (DD) may cause some hygromas. Poor footing (slippery slatted concrete) can also be an important contributor to the condition by splaying the digits. Also, combinations between these factors are seen when ID is a herd problem.

### Treatment

In simple cases or in those in which lameness is not a factor, treatment of the ID, DD, or sole ulcer together with a change of the causing environment may be sufficient to allow spontaneous healing. In more advanced cases surgery is required. However, if the conformation of the foot is poor or if the causative environmental factors are not eliminated there is a high risk for reoccurrence.

### Surgical Removal

See Figures 17-75 to 17-81.



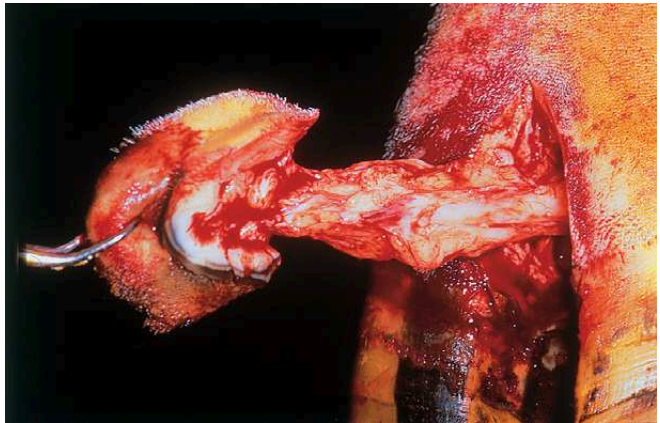
**Figure 17-75** The interdigital space proximal to the lesion must first be infiltrated with a local anesthetic. Alternatively, regional intravenous anesthesia is recommended as it has the advantage that the tourniquet achieves hemostasis. The digits are pulled well apart in order to thoroughly cleanse and sterilize the lesion and the attaching skin. (Courtesy of J Ferguson)



**Figure 17-76** The hyperplasia should be grasped firmly with forceps (Allis tissue or Backhaus towel forceps). The fibroma should be pulled distally as far as possible to enable access to the attaching interdigital skin. The yellowish tinge to this and the following slides in this series is due to the application of an iodine-based sterilizing agent. (Courtesy of J Ferguson)

**Cryosurgery**

A tourniquet must be applied to minimize the cooling effect of circulating blood. The cryosurgery needle is applied longitudinally through the center of the fibroma, and freezing continues until the tissue is frozen. The needle is withdrawn and a flexible mandrin is inserted and left in the channel until thawing is complete. A second treatment is then required. The tourniquet is released 15 minutes after the second freezing.



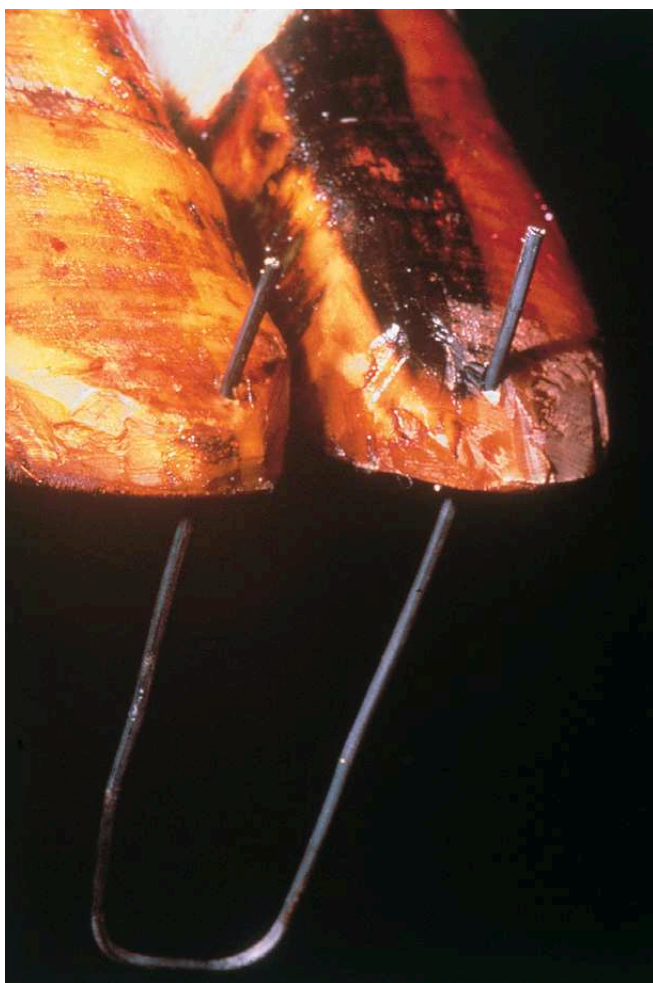
**Figure 17-78** Once the hyperplasia has been removed, part of the interdigital fat pad in the anterior region of the interdigital space should also be excised. This is mainly practiced if the hyperplasia is removed from the anterior part of the cleft. The wound should then be dressed with antibiotic powder which may be held in place by a small sanitary napkin. Immobilization of the digits helps the healing process. (Courtesy of J Ferguson)



**Figure 17-77** When making the incision around the fibroma, as much skin as possible should be preserved. Suturing is impossible under field conditions. However, healing is likely to be more rapid the more skin that can be preserved. (Courtesy of J Ferguson)



**Figure 17-79** The claws should be prevented from splaying apart and delaying healing by means of wiring the claws together. Holes should be drilled in the apex of each claw. (Courtesy of J Ferguson)



**Figure 17-80** Steel wire is then threaded through the holes. Ideally two holes should be drilled in the tip of each claw as only one loop of wire will often cut through the horn. The toes are then wired together in order to prevent the claws spreading apart or moving relative to one another. Movement will delay healing. A bandage should be applied and covered with a plastic bag. The bag should be held in place and protected with a further elastic bandage. The wound should be redressed in five days. (Courtesy of J Ferguson)

### Prevention

Control of ID and DD in dairy herds will reduce the occurrence of this condition. The slipperiness and unevenness of floors should be corrected, as well as unstable concrete on slatted floors or slats that are too wide. Control of interdigital hyperplasia in heavy beef animals should be directed towards reducing the genetic influence of affected animals.



**Figure 17-81** The two ends of the wire are twisted tightly together and the ends cut short. (Courtesy of J Ferguson)

### BIBLIOGRAPHY

- Anderson D E, Allen D, St-Jean, et al 1997 Use of a multifenestrated indwelling lavage system for treatment of septic digital tenosynovitis in cattle. *Australian Veterinary Journal* 75:796–799
- Anderson D E, St-Jean G 1996 Diagnosis and management of tendon disorders in cattle. *Veterinary Clinics of North America: Food Animal Practice* 12:85–116
- Anderson D E, St-Jean G, Morin D E et al 1996 Traumatic flexor tendon injuries in 27 cattle. *Veterinary Surgery* 25:320–326
- Baxter G M, Lakritz J, Wallace C E, Broome T A, Parks A H 1991 Alternatives to digit amputation in cattle. *Compendium of Continuing Education Practicing Veterinarians, Food Animal Practice* p 1022–1035
- Budras K-D, Habel R E 2003 *Bovine anatomy*. Schlütersche GmbH and Co, Hanover, Germany
- De Lahunta A, Habel R E 1986 *Applied veterinary anatomy*. W D Saunders Philadelphia
- Desrochers A, Anderson D E 2001 Surgical treatment of lameness. *Veterinary Clinics of North America: Food Animal Practice* 17:143–158
- Desrochers A, St-Jean G, Anderson D E 1995 Use of facilitated ankylosis in the treatment of septic arthritis of the distal interphalangeal joint: 12 cases (1987–1992). *Journal of the American Veterinary Medical Association* 206:1923–1927
- Dyce K M, Sack W O, Wensing C J G 1987 *Textbook of veterinary anatomy*. W D Saunders, Philadelphia

- Gagnon H, Ferguson J G, Papich M, Bailey J V 1994 Single-dose pharmacokinetics of cefazolin in bovine synovial fluid after intravenous regional injection. *Journal of Veterinary Pharmacology and Therapy* 17:31–37
- Gordon P J, Weaver M P et al 1996 Resection of the distal interphalangeal joint in cattle: a salvage technique for septic arthritis. *Cattle Practice* 4:209–212
- Greenough P R 1989 Lameness: surgical consideration. *British Cattle Veterinary Association Proceedings* p 121–126
- Greenough P R, Ferguson J 1985 Alternatives to amputation. *Veterinary Clinics of North America: Food Animal Practice* 1:195–204
- Kersjes A W, Nemeth F, Rutgers L J E 1985 Atlas of large animal surgery. Williams & Wilkins, Baltimore and London
- Kofler J 1988 Zur Therapie der Arthritis Infectiosa Articulationis Interphalangeae Distalis beim Rind: Vergleich der Operationsmethoden 'Amputation im Kronbein' und 'Exarticulation im Krongelenk'. Inaugural Dissertation. Veterinary Medical University of Vienna
- Kofler J, Martinek B 2004 Therapy of septic digital flexor tenosynovitis and concurrent septic arthritis of the fetlock joint in 2 cattle: new surgical approach from plantar via the digital flexor tendon sheath wall. *Proceedings of 13th International Symposium of Disorders in the Ruminant Digit*, p 128–129
- Kofler J, Martinek B 2004 Treatment of infected wounds and abscesses in bovine limbs with ligasano-polyurethane-soft foam dressing material. *Proceedings of 13th International Symposium of Disorders in the Ruminant Digit*, p 229–231
- Müller K 1991 Resection of the tip of the bovine claw. *Pract Tieraertz* 12:1112–1113
- Nickel R, Schummer A, Seiferle 1981 The anatomy of the domestic animals Vol. 3 The circulatory system, the skin and the cutaneous organs of domestic mammals. Springer-Verlag, New York, p 524–536
- Nomina Anatomica Veterinaria and Histologica, 4th edn 1994 International Committee on Veterinary Gross Anatomical Nomenclature, Ithaca, New York
- Nuss K, Weaver M P 1992 Resection of the distal interphalangeal joint in cattle: an alternative to amputation. *Veterinary Record* 128:540–543
- Osman M A R 1970 A study of some sequelae of amputation of the digit using three operative techniques. *Veterinary Record* 87:610–615
- Pejsa T G, St-Jean G et al 1993 Digital amputation in cattle: 85 cases (1971–1990). *Journal of the American Veterinary Medical Association* 202:981–984
- Petzoldt F J Fractures of the distal phalanx in the bovine. Inaugural dissertation, Faculty of Veterinary Medicine, Ludwig-Maximilians-Universität, Munich, Germany
- Sisson S, Grossman J D 1975 The anatomy of the domestic animals, Vol 1. W B Saunders, Philadelphia
- Starke A, Heppelmann M, Kehler W, Meyer H, Kaske M, Rehage J 2004 Septic Arthritis of the distal interphalangeal joint in HF cows: Controlled clinical study comparing the efficacy of digital amputation and resection of the coffin joint. *Proceedings of 13th International Symposium of Disorders in the Ruminant Digit*, p 124–125
- Steiner A, Habil M S 2000 Fenestration of the abaxial hoof wall and implantation of gentamycin-impregnated collagen sponges for treatment of septic arthritis of the distal interphalangeal joints in 7 cattle. *Proceedings of 11th International Symposium of Disorders in the Ruminant Digit*, Parma, p 271–272
- Steiner A, Ossent P, Mathis G A 1990 Intravenous regional anesthesia and antibiotic therapy applied to the limbs of cattle: indications techniques and complications. *Schweiz Arch Tierheilkd* 132: 227–237
- Trent A M, Plumb D 1991 Treatment of infectious arthritis and osteomyelitis. *Veterinary Clinics of North America: Food Animal Practice* 7:747–778
- Vecchis de L 2002 Field procedures for treatment and management of deep digital sepsis. *Proceedings of 12th International Symposium of Disorders in the Ruminant Digit*, p 109–116
- Weaver A D 1991 Performing amputation of the bovine digit. *Veterinary Medicine* p 1230–1233

## Disorders Affecting the Upper Limb

### GLOSSARY

**Exostosis(es):** A spur or bony outgrowth from a bone.

**Ankylosis:** Fixation of a joint due to fusion of the bones.

**Spondylosis:** Disease affecting the vertebrae.

**Arthropathy:** A disease of a joint.

**Osteochondrosis:** A disease process involving the bone growth centers.

**Osteochondritis:** An inflammatory process involving the bone growth centers.

**Creptitation:** A creaking, cracking, grating sound.

**Auscultation:** The detection and study of sounds coming from an organ or joint.

**Acetabulum:** The cup in the pelvis into which the head of the femur fits.

**Arthroscopy:** The use of a special instrument to examine the inside of a joint.

**Dysplasia:** Abnormal development or growth.

**KEY CONCEPTS**

- Over 90% of the lesions causing lameness occur in the foot. Therefore, always start with a thorough foot examination.
- If there is no visible lesion and piners tell you nothing, eliminate the foot as the seat of lameness by using a regional nerve block.

**SPINAL CORD DYSFUNCTION****KEY CONCEPTS**

- Bilateral total or partial inability to use the hindlimbs.
- Likely to be progressive.
- Usually unresponsive.
- Prognosis extremely poor.

Some causes of spinal cord dysfunction are almost impossible to diagnose in the living animal. Spinal lymphoma, vertebral abscess and migrating parasite larvae are examples.

**Ankylosing Spondylitis****Description**

Varying degrees of ataxia may precede the extreme phase of the disorder. The diagnosis can be confirmed from rectal palpation, when exostoses can be identified running along beneath the lumbar spine and sacrum.

See Figures 18-1 and 18-2.

**Cause**

It is presumed that exostoses form around the ventral aspect of the last few lumbar intervertebral joints as the result of years of mounting and serving cows. Eventually, the exostosis breaks at some point and fluid is released which causes pressure on the spinal cord, resulting in partial or total paralysis.

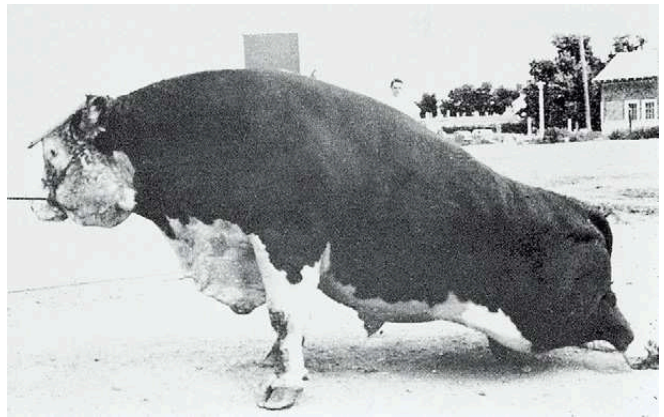


Figure 18-1 The patient, usually an older heavy bull, is able to stand on its forelimbs but drags its hindlimbs behind it. (Courtesy of B Welker)



Figure 18-2 As the animal ages, the long ventral ligament of the vertebral column forms a thick bony cast (exostosis) beneath vertebrae of the loin and the sacrum.

**Treatment**

The disorder is irreversible and there is no treatment; euthanasia is the only option.

**Broken Back****Description**

This is a traumatic injury usually caused as the result of riding. It is characterized by a dog sitting posture and lack of hindlimb sensation.

See Figure 18-3.



**Figure 18-3** This animal has a broken back. Although similar in appearance to the animal in Figure 18-1, there is no sensation in the hindlimbs. (Courtesy of B Welker)

## Pressure on the spinal cord

### Description

Pressure from a slipped intervertebral disc, a spinal abscess, migrating parasites, or a vertebral fracture may cause pressure on the spinal nerve. In a recently calved cow, the appearance of this lesion would appear to be very similar to that caused by ischiadic paralysis and would be a possible cause of downer cow (see p. 155).

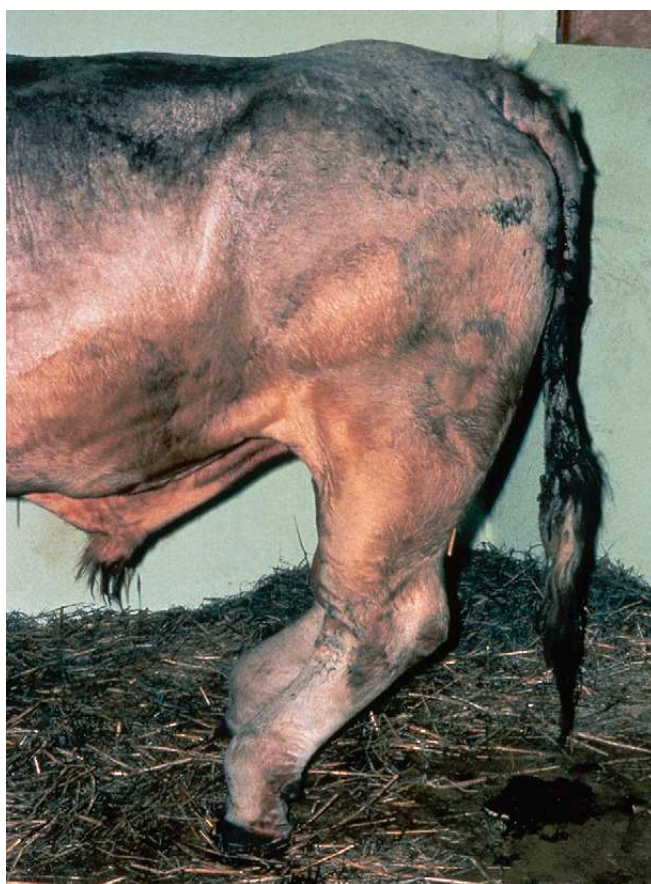
See Figure 18-4.

## Degenerative Arthropathy, Degenerative Joint Disease (DJD), Osteochondrosis, and Osteochondritis Dissecans

### Description

The animal presented will have difficulty walking, and despite extensive examination a seat of lameness cannot be found in the foot. Most probably the animal will be mature, over 4 years of age. The exception may be young bulls fed high-grain diets for the show ring. They may become lame when as young as 6–12 months of age.

There will be a wasting of muscles around the affected joint, most commonly the hip. On auscultation, grating sounds (crepitation) can be heard in the joint. Sometimes the noise made by the joint is audible without the aid of a stethoscope. The onset of the condition is gradual, and it is usual that some degree of pathological abnormality will be present in the opposite hip joint. Evaluation of the joint fluid and arthroscopy can provide useful information if the cost is warranted (see p. 246).



**Figure 18-4** This is the typical stance of spinal cord injury. The hock has dropped and the fetlock knuckled. (Courtesy of B Welker)

### Cause

This disorder is a chronic progressive degeneration of articular cartilage. The condition can affect any joint in the body. In cattle it is most commonly reported in major weight-bearing joints, particularly the hip. Sometimes the shoulder and stifle are affected. The earliest changes occur in the acetabulum and on the dorsomedial surface of the femoral head. The stifle may be affected, with the medial condyle of the femur showing the earliest changes.

Inherited predisposition to degenerative arthropathy is probable and it has been proposed that there is a relationship between this disorder and straight limb conformation. Nutritional factors may be involved in some instances, particularly if the ration is high in phosphorus and low in calcium. This metabolic disturbance probably influences the strength of bone beneath the articular cartilage of the joint. Copper deficiency or fluoride toxicity also may act similarly. Joint instability such as occurs in the stifle after trauma is a common cause. Forced traction of a calf in breech presentation (hind





**Figure 18-5** The appearance of the acetabulum of a cow with advanced arthritis of the hip.

legs first) can reduce the blood supply to the hip joint, and arthritis may result.

The condition should not be confused with hip dysplasia which is heritable, usually bilateral, and found mostly in the English breeds of young beef cattle, predominantly males. The disorder may be suspected in weak calves having difficulty in rising.

The clinical signs of hip dysplasia may be slow in onset and may take the form of lameness or ataxia involving the hindlimbs. There is usually a reduction in weight gain. On radiographic evaluation, the acetabulum appears to be shallower than normal, exostoses may be present, and some degree of dislocation (subluxation) may be evident.

See Figure 18-5.

### Treatment

Changes in the joints are usually irreversible by the time the diagnosis is made.

## MUSCULOSKELETAL DYSFUNCTION

### Dislocation of the Hip (Coxofemoral Luxation)

#### KEY CONCEPT

- Calves are most likely able to walk with response to treatment (over 75%). Over 50% of adults able to walk will respond to treatment. The affected limb is dragged behind the sound limb.

### Description

Over 75% of hip dislocations occur in an upward direction. As the head of the femur comes to rest on the wing of the ilium, the hock will be markedly turned inwards. The remaining number of dislocations are downwards, with the head of the femur coming to rest in the obturator foramen. Inward rotation of the hock will also occur, but it will be less obvious. The affected limb will be dragged behind the sound limb. In the case of upward dislocation, the hip will seem to be larger and higher and the point of the hock higher than on the opposite limb. The converse will be the case if the dislocation is downwards.

Deep palpation of the hip when the cow is lying on its side with the affected hip uppermost provides helpful information. In this position the limb should be alternately flexed, extended and rotated by an assistant. Cracking and grating sounds (crepitation) may be detected. However, if the crepitation is excessive, the possibility of fracture of the neck of the head of the femur or the rim of the acetabulum should be considered. In these instances satisfactory resolution is unlikely. Rectal palpation should be performed to ensure that the head of the femur is not located in the obturator foramen.

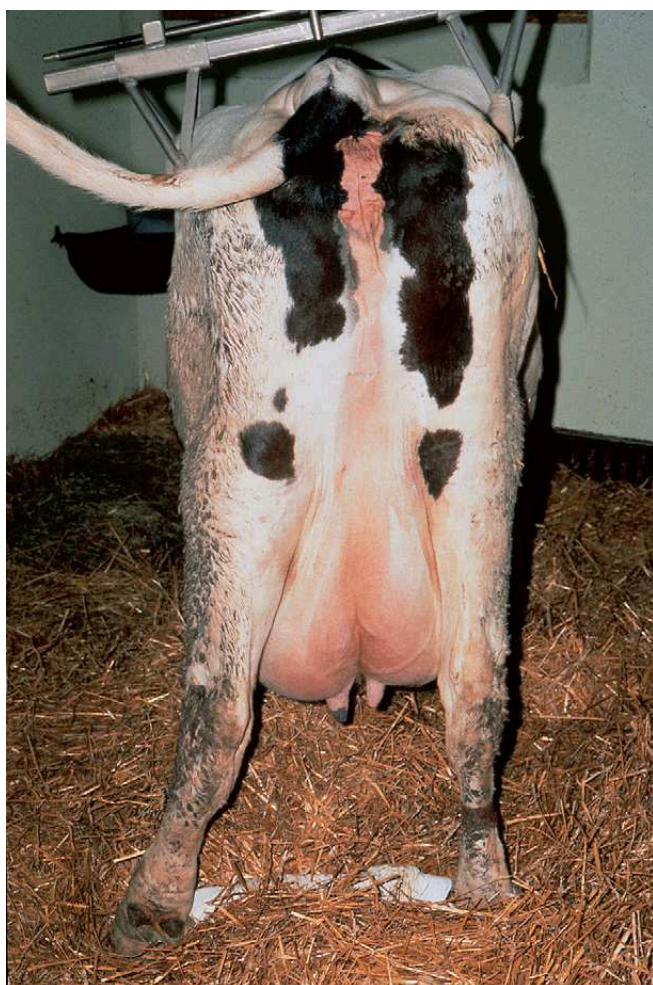
If both hips are dislocated, the cow will almost certainly be recumbent and the prognosis will be extremely poor. See Figures 18-6–18-8.

### Cause

The cow may have been seen slipping or there may be a history of the animal falling when attempting to ride another cow. Downer cows can dislocate their hip when they struggle to rise.



**Figure 18-6** An animal with an upwardly dislocated hip invariably has a swelling above the hip on the affected side. (Courtesy of B Welker)



**Figure 18-7** In the case of downward dislocation of the hip the hock appears to be lower on the affected side. The whole limb is rotated inwards. Note that hobbles have been applied. (Courtesy of B Welker)

### Treatment

Success with replacing a hip depends, to a large extent, on the rapidity with which the replacement procedure is undertaken. The ligament of the head of the femur and the transverse acetabular ligament are injured as the head of the femur dislocates. Irreparable damage to these structures occurs when the cow struggles to rise. Another problem is the escape of blood and serum which will clot and fill the acetabular cavity.

The patient should be taken to a suitable site. There should be ample bedding close to an immovable structure (tree or a pillar in an open hay barn). The patient should be deeply sedated to the level of recumbency. The cow is placed with its back close to this structure with the dislocated hip uppermost. A rope is fixed around the fixed structure and up into the groin of the patient. A



**Figure 18-8** If the animal is lying down it can be rolled on its side. Deep palpation of the hip region is most useful when the limb is rotated and alternately flexed and extended by an assistant. Abnormal movement of the head of the femur can be felt and loud creaking noises heard if the hip is dislocated or damaged. (Courtesy of B Welker)

block and pulley is tied to the lower metatarsus. The use of a muscle relaxant is useful. Some operators will use a short-term anesthetic.

A tractor or power take-off should never be used to provide the pull needed to replace a hip. However, a tractor can be used to provide a second fixed point to which a block and pulley can be attached. Man-power applied to the pulley will provide smooth controllable traction.

The direction of the pull is critical. The force should be applied slightly backward in a manner that will draw the head of the femur over the ramus of the ilium. The head of the femur will have rotated outwards as it dislocates and will come to rest on the ilium. During the next phase of the pull, the point of the hock should be grasped and strongly rotated upward until the head of the femur slips back into the acetabulum. The operator should not be discouraged if the first attempt is unsuccessful; change the angle of the pull and try again. Sometimes during traction, the head of the femur will slide silently back into the acetabulum without the operator being aware that the dislocation has been resolved. Re-evaluation of the dislocation should be made between each attempt.

If damage to the hip joint is too extensive, replacement will not be successful and a false joint (pseudoarthrosis) will develop, causing the animal to be crippled for the remainder of its life.

Up to 25% of hips that are successfully replaced will re-luxate. Hobbling the feet together for 10–14 days after replacement may reduce the incidence of this occurring.

See Figure 18-9.



**Figure 18-9** A rope should be looped around the groin of the affected limb, which should be uppermost. The free ends of the rope should be tied around the immovable fixed point. A second rope is then tied around the lower metatarsus and a considerable amount of manual traction applied by block and pulley.

### Rupture of the Cruciate Ligament of the Stifle (Femorotibial Instability)

#### Description

The mature cow or bull presented will be lame and perhaps standing with the fetlock lightly flexed and the heel raised. It will not be possible to find the seat of lameness in the foot. Sliding of the femoral condyles over the tibial plateau may be heard or felt when the animal is walking. There may be excessive rotary motion of the stifle when the lower leg is manipulated. Some swelling around the stifle joint may be detected.

To confirm this diagnosis the clinician should attempt to produce the 'drawer sign.' Standing behind the animal, the hands should be clasped together just below the stifle (over the tibial crest). The hock should be stabilized with the operator's knee. Backwards force is applied to the tibial crest. The tibia should be pulled backwards with a quick motion and it will be felt to slide back into its normal position.

#### Cause

The rupture can be caused by a fall, often during sexual activity, resulting in a severe twisting of the stifle joint. The condition may also be secondary to chronic degenerative joint disease. The trauma causes the anterior cruciate ligament of the joint to rupture.

#### Treatment

Various surgical procedures have been developed to repair the damage.

### Dislocation of the Knee Cap (Patellar Luxation)

#### Description

The patient presented will be young, although animals up to 2 years of age may be affected. Changes in hindlimb gait can be quite variable but are generally characterized by jerkiness. Intermittent fixation of the patella on the upper part of the femoral trochlea results in a characteristic jerky action of one or both hindlimbs. The limb can remain hyperextended for a longer period than normal and may even be dragged for a few steps before clicking forward to a normal posture.

Many patients will show wasting of muscles. If the femoral nerve is damaged, there will be progressive wasting and dysfunction of the quadriceps muscles.



**Figure 18-10** Bilateral patellar luxation in a calf. (Courtesy of Anon)



**Figure 18-11** This is a case of upward fixation of the patella. The animal cannot voluntarily flex its stifle. (Courtesy of B Welker)

Careful palpation of the patella may detect a displacement of the bone. This may be confirmed from a cranio-caudal radiograph of the stifle joint.

See Figures 18-10 and 18-11.

### Cause

Forced traction during the birth of a calf presented hind feet first (breech) is a common cause of patellar dislocation. In these cases there may be inflammatory edema in the region. A congenital form of lateral dislocation of the patella has been described. If damage to the femoral nerve is the cause of the dislocation, natural resolution may occur within one month.

### Treatment

With the limb in full extension, the patella can be repositioned, although re-luxation is usual. Various surgical procedures have been described.

## Serous Tarsitis (Tarsal Hydrarthrosis, Bog Spavin, or Puffy Hock)

### Description

Puffy hocks are often seen in related animals. Therefore, there is probably a genetic component to this disorder. The disorder does not cause pain or lameness. In later life, there may be a predisposition to arthritis. The condition is diagnosed by depressing the swelling of the joint capsule at one location and palpating the fluctuation that will occur at another. There is no successful treatment.

See Figure 18-12.

## Tarsal Cellulitis (Tarsal Bursitis, Concrete Hock)

### Description

#### KEY CONCEPT

- This condition is usually associated with poor stall design or management.

The swelling starts off being firm. At this stage the condition has little effect on joint mobility. As the swelling increases, soft spots can be felt. These lesions will become painful to touch and eventually rupture to discharge pus.

See Figure 18-13.



Figure 18-12 Serous tarsitis (puffy hock) is characterized by three, soft, fluctuating swellings between the ligaments of the femorotarsal joint.

### Cause

Tarsal cellulitis is caused by pressure on the skin and subcutaneous tissue overlying bony prominences. The usual cause is lack of proper bedding or stalls or cubicles that are too short, causing the hock to come into contact with the curb when the animal is lying down. Frequently, these lesions start as bed sores.

See Figure 18-14.



**Figure 18-13** This condition may be confused with puffy hock. The skin, usually on the outside surface of the hock, may be swollen and the surface may be raw and eventually discharge pus. (Courtesy of B Welker)

## Treatment

### GLOSSARY

**Antiphlogistine:** This is the proprietary name for a product containing clay, glycerine, as well as antiseptic and aromatic substances. This product makes an exceptional poultice.

**Poultice:** This is a hot compress useful to reduce inflammation and stimulate the maturation of an abscess. Bran (or cooked rice) to which boiling water is added is the best simple material to use in a poultice. It is easier to handle if layered between squares of gunny sack. Poultices can be reheated by steaming.

Attempts to drain pockets of fluid must be carried out with extreme caution to avoid accidental entry of the joint capsule. The whole hock should be thoroughly cleansed. The most rapid method of resolving this condition is to apply a hot poultice. Antiphlogistine should be sandwiched between two pieces of cloth. It should be applied to the swollen area and covered with cotton batten. The whole is kept in position by a bandage or long strips of gunny sack. The animal attendant should re-heat the poultice and re-apply it twice each day. Antibiotic injections may be needed in really serious cases.



Figure 18-14 If the stall is too short for the cow or if the bedding is piled too high in the front of the stall the cow will lie with the hock rubbing on the concrete curb. Infection usually starts from bed sores.

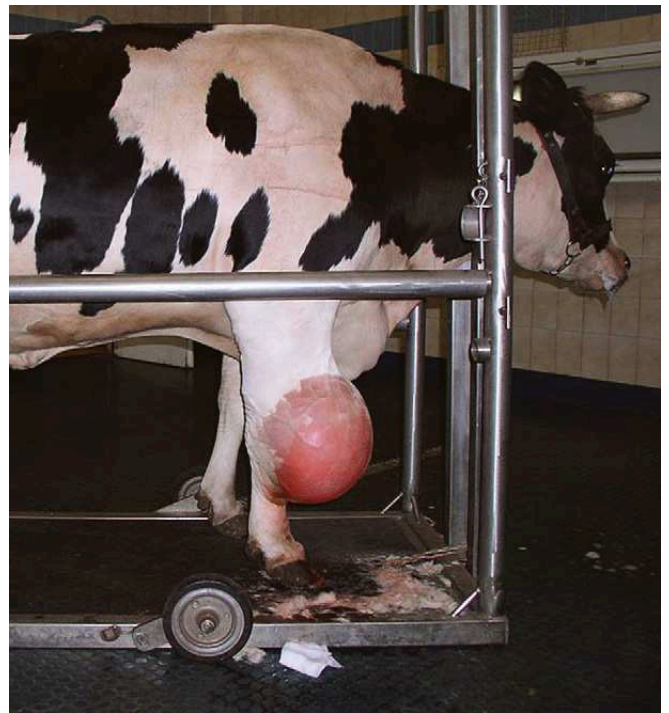


Figure 18-15 A carpal hygroma is a swelling on the dorsal surface of the knee (carpus). (Courtesy of J Ferguson)

## Carpal Hygroma

### KEY CONCEPT

- Avoid surgical interference at all costs and do not inject irritant fluids into the lesion.

### Description

A carpal hygroma is a painless swelling on the dorsal surface of the carpus (Fig. 18-15). Some of the lesions may be quite firm to the touch, while in others fluid may be detected.

### Cause

Chronic trauma occurring over months is the direct cause of this condition. The most common offender is a poorly designed stall in which the brisket board or edge of the manger contacts the knees (carpus) either when the animal rises or lies down. Lack of proper bedding may be a contributing factor. The hygroma may involve the carpal bursa or may result from an extension of scar tissue. Occasionally, *Brucella abortus* may be isolated in countries where this organism has not been controlled.

### Treatment

If the animal with a hygroma is milking and eating well it is probably best to avoid surgical treatment. However,

if it is decided to attempt surgery it is essential that all of the lining of a fluid sac, if present, must be excised. If any of the sac is left fluid will reform. The surgery is often a bloody procedure and wound healing after surgery may be prolonged. Breakdown of the wound from further trauma is common as is subsequent infection.

## Hematoma

### KEY CONCEPT

- If the hematoma is closed, leave it that way. Always collect fluid with needle and syringe from soft swellings to determine the nature of the lesion.

### Description

Ninety percent of soft fluid swellings on the upper limbs or abdomen are likely to be a hematoma. The first step must be to confirm the diagnosis by taking a sample of the contents of the swelling. Using aseptic precautions a large bore needle should be thrust into the swelling and the contents aspirated into a hypodermic syringe:

- The fluid from a hematoma will be serum or a disintegrated blood clot.
- The fluid from a hernia may be clear fluid or intestinal contents.
- The fluid from an abscess will be pus.

Ultrasonography is proving useful for exploring the characteristics of some hematomas.

### Cause

Hematomas are caused by accidental rupture of blood vessels that are vulnerable to external trauma. One cow butting another is a common cause. A group of animals all rushing to pass through a narrow doorway at the same time can result in the traumatic rupture of blood vessels.

### Treatment

In the majority of cases, it is advisable to leave a hematoma untreated. In time the hematoma will shrink. It is probable that an unsightly lump will remain but this is preferable to the risks involved in attempting to drain the lesion.

The ruptured vessels causing a hematoma to form will bleed for many days until the pressure inside the confining structures equals that of the circulation. Should the swelling be incised within 7–10 days of its appearance there is a considerable risk that the bleeding can not be stopped. Finding and ligating a ruptured blood vessel among the massive blood clots which will have formed is usually an impossible task. When this happens the cavity should be packed tightly with wide strips of cloth and the wound sutured. Invariably, secondary infection will take place, and what was initially a simple problem can turn into a life-threatening incident.

## Rupture of the Gastrocnemius Muscle or Tendon

### KEY CONCEPTS

- The reciprocal apparatus of the stifle is an arrangement of muscles and tendons that forces the stifle and the hock to move in unison. Rupture of any part of the apparatus causes changes in the ability to flex or extend these joints.
- If the gastrocnemius muscle or tendon is ruptured, the stifle can be extended while flexing the hock.

### Description

This problem is usually unilateral. The animal is unable to bear weight on the affected limb. When presented, the hock will be dropped to a position lower than normal. In older cattle, a rectal examination should be performed to check that the pelvis is not fractured. At the same time the ureters should be examined and if enlarged suggest the possibility of pyelonephritis, which has been associated with the rupture of this muscle. Care must be taken to differentiate this condition from unilateral ischiadic paralysis.

See Figures 18-16 and 18-17.

### Cause

A wound between the point of the hock and the back of the thigh will suggest direct injury to the muscle or tendon. If there is a history of an injection of an oil-based agent in the region of the thigh, this possibility should be investigated. If there is a history of recumbency with the animal struggling to rise, this is likely to be the cause



**Figure 18-16** Rupture of the gastrocnemius muscle is relatively rare, while rupture of the Achilles tendon is a little more common. (Courtesy of B Welker)

of the damage. Spontaneous rupture may be associated with deficiencies of calcium, phosphorus, and/or vitamin D.

See Figure 18-18.

### Treatment

There is no successful treatment for rupture of the gastrocnemius muscle in heavy cattle. The limb may be fixed in



Figure 18-17 In the case of partial rupture of the gastrocnemius muscle or tendon the hock will sink. This is impossible to differentiate from tibial nerve paralysis. (Courtesy of B Welker)



Figure 18-18 This is a picture of an abscess resulting from an injection which has caused rupture of the Achilles tendon.

a Thomas splint or padded fiberglass cast if the animal is young and light in weight but recovery will take several months. Various surgical procedures have been described for repairing a traumatically severed Achilles tendon.

### Rupture of the Peroneus Tertius Muscle

#### Description

The stifle remains flexed when the hock is extended. This is a weight-bearing lameness so at rest the animal appears to be perfectly normal. However, when it attempts to walk, the foot may be dragged and the Achilles tendon will appear to be slack.

See Figure 18-19.

#### Cause

The peroneus tertius muscle originates at the back of the femur and terminates into various points on the tarsus and metatarsus. It, therefore, counteracts the pull of the gastrocnemius muscle. This muscle is ruptured during some traumatic accident. Unskilled use of ropes or equipment for lifting the limb, or slipping when riding during estrus are common causes.

#### Treatment

There is no appropriate treatment for this condition. Prolonged rest may see the condition gradually resolve. If the insertion of the muscle tendon breaks away from the bone the prognosis for recovery may be less than 50%. If the muscle itself is ruptured, the prognosis will be somewhat better.



Figure 18-19 The diagnosis of a ruptured peroneus muscle can be confirmed by pulling the limb caudally, when there will be no resistance. The limb can be pulled backwards parallel to the ground. (Courtesy of B Welker)



## Contracted Tendons in Calves

### Description

Some degree of flexor tendon contraction is seen in many new-born calves, and for the most part the condition resolves naturally. However, there is a wide range of flexor deformities. The more joints involved, the more guarded should be the prognosis.

See Figures 18-20 and 18-21.

### Cause

Usually this is a congenital problem. Some cases occur as the result of a pregnant cow eating lupine plants. The resulting calves are unsuitable candidates for treatment. The same applies to calves diagnosed with arthrogryposis, which is the permanent contracture of multiple joints.

### Treatment

If the limb can be forcibly straightened sufficiently for at least the apex of the claw to touch the ground in a normal

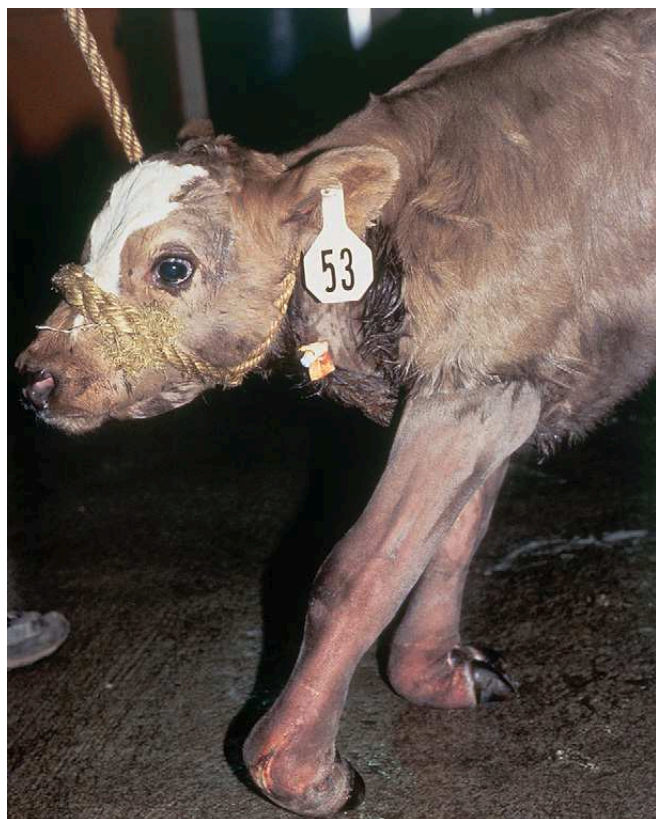


Figure 18-20 A calf with typical bilateral contracted tendons of the forelimbs. (Courtesy of B Welker)



Figure 18-21 A calf with unilateral contraction of the tendons of the forelimb. (Courtesy of Anon)

standing posture, the limb can be splinted in that forced extended position. The splint should be removed and re-applied after 48 hours. This procedure may be repeated so long as some improvement can be detected and/or the animal's ability to stand does not deteriorate. A splint can be constructed from a length of plastic drainage pipe of an appropriate diameter. The pipe is cut in half length-wise and padded with cotton batten or foam rubber. The two sides of the splint are closed on the limb with duct tape.

Surgical interference has been recommended. The tendons can be cut in the middle of the metacarpus/tarsus using full aseptic precautions. Tranquilization and local anesthesia are administered. The skin is incised on either side of the tendons. Great care must be taken to avoid cutting the nerves and blood vessels that run in the grooves at the side of the tendons. Before complete relaxation of the limb can be achieved, both deep and superficial tendons must be cut – and sometimes the suspensory ligament as well. The limb should then be splinted or plastered.

## Neonatal Polyarthritis (Joint III, Navel III)

### Description

The patient when presented will be just a few weeks old. Sudden swelling of several joints will have been noticed and the animal will be reluctant to rise. The body temperature is likely to be elevated and joints will be tender to the touch. The umbilical scar may show no evidence

of abnormality, although swollen tissues may be palpated in the abdomen in the proximity of the umbilicus. Radiology of the joints may be useful in establishing a diagnosis.

The amount of fluid that can be aspirated from the joint will be greater than normal. There will be a very distinct change in the appearance of the fluid and although it may be impossible to culture organisms from the fluid, smears may show that bacteria are present.

**Cause**

*Streptococcus* spp. are probably the most common cause of this condition in new born calves. However, *Escherichia coli*, *Actinomyces pyogenes*, *Proteus* spp. and *Staphylococcus* spp. have also been isolated.

See Figures 18-22 and 18-23.

**Treatment**

Most antibiotics are effective, with treatment continuing daily for 10–14 days.

**Control**

The disease is most commonly encountered in locations where the calves are born and/or spend their early life in unhygienic conditions. Regular cleansing and disinfection of the area set aside for calves is mandatory. Dipping the navel in a suitable fluid immediately after birth is strongly recommended.



Figure 18-23 A radiograph of a fetlock joint of a calf affected with polyarthritis. (Courtesy of B Welker)



Figure 18-22 In this case, the right knee (carpus) is causing the animal with polyarthritis some distress. It also appears to be experiencing discomfort on the other limbs. (Courtesy of B Welker)

**Spastic Syndrome (Progressive Hindlimb Paralysis)**

**KEY CONCEPTS**

- This is a curious condition that should not be confused with spastic paresis or bovine spongiform encephalopathy (BSE or mad cow disease.)
- Not seen before the animal has reached the age of 3–7 years.

**Description**

The condition starts gradually with an intermittent twitching of the muscles of the hindlimb (Fig. 18-24). The twitching becomes more distinct and spasmodic and eventually the affected animal will be unable to rise. The spasms may be produced by a variety of stimulæ such as the effort involved in rising, some sudden

stressor, or a painful foot lesion. Between attacks, the animal may appear to be perfectly normal.

**Cause**

Spastic syndrome is regarded as a genetic disease. Very little is known about the etiology and pathology.



**Figure 18-24** Twitching and inability to walk forward usually occur as the animal attempts to rise. When the animal is recumbent it appears to be normal. (Courtesy of Anon)

### **Treatment**

This disease is progressive and incurable. Because this disorder is believed to be heritable, the animal should not be used for breeding and related animals should be monitored closely. Palliative treatment for animals in the peak of production may be helpful. Mephenesin (30–40mg/kg, p.o., for 2–3 days) may be given during an episode. Phenylbutazone may also have beneficial effects.

### **Spastic Paresis (Elso Heel)**

#### **Description**

Awareness of spastic paresis was increased with the discovery in Holland of a bull named Elso II which had a number of descendants affected with this disorder. It differs from the spastic syndrome in two notable features, namely, that spastic paresis is first seen in young animals,



**Figure 18-25** An animal with spastic paresis has a hindlimb that is extremely straight. When it walks, the limbs are swung without any flexion of the stifle or hock. (Courtesy of B Welker)

and the straight-limbed appearance (Fig. 18-25) is continuous rather than intermittent. Some concern has been expressed regarding some similarities between this condition and bovine spongiform encephalopathy (BSE).

The first sign of this disorder is stiffness. The patient will almost certainly be young, that is less than 6 months of age, when the first signs of the disorder are seen. Stiffness increases in severity until the extensor muscles of one or both hindlimbs contract and cause the leg to straighten. When this occurs, the animal appears to have ultra-straight limbs or limb and walks with a swinging motion bearing weight on the tips of the toes. There is no spasm, as such, as the animal walks, but it appears that the very effort to walk stimulates a 'spasm' of the muscles involved.

### Treatment

This is an incurable disorder and it can be argued that palliative surgical treatment is not cost effective. As the condition is heritable, the animal should be eliminated from the breeding program and relatives examined for evidence of abnormally straight-legged posture. Some workers believe that an animal which is 'post-legged' is more likely to be affected than those with normal hindlimb conformation.

There are a number of reports of different methods of palliative surgical treatment. One technique is to cut the tibial nerve, which produces sufficient relief to permit a steer to be finished for slaughter. This nerve is accessed by a caudal approach between the bellies of the gastrocnemius muscle. It must be sectioned at a level high enough to eliminate most of the supply to the gastrocnemius. The peroneal nerve lies very close to the tibial nerve at this level and electrostimulation has to be used to identify each of the two nerves.

Partial tenectomy of the two insertions of the gastrocnemius muscle is an alternative option. The calcanean tendon sheath remains to give sufficient support to avoid the problem of the dropped hock.

## BIBLIOGRAPHY

- Arnault G A 1982 Bovine spastic paresis. An epidemiologic, clinical and therapeutic study in a Charolais practice in France. Efficacy of lithium therapy. World Association of Buiatrics. Proceedings of the 12th World Congress on Diseases of Cattle, Amsterdam, The Netherlands 11:853–858
- Baird A N, Angel K L, Moll H D et al 1993 Upward fixation of the patella in cattle: 38 cases (1984–1990). *Journal of the American Veterinary Medical Association* 202:434–436
- Bargai U 1993 Myelography in neonatal bovine calves. *Veterinary Radiology Ultrasound* 34:20–23
- Bargai U 1992 Tarsal lameness of dairy bulls housed at two artificial insemination centers: 24 cases (1975–1987) *Journal of the American Veterinary Medical Association* 201:1068–1069
- Biss M E, Hathaway S C 1994 Wastage due to diseases and defects in very young calves slaughtered in New Zealand. *New Zealand Veterinary Journal* 42(6):211–215
- Bradley R, Wijeratne W V S 1980 A locomotor disorder clinically similar to spastic paresis in an adult Friesian bull. *Veterinary Pathology* 17:305–317
- Cordy D R 1986 Progressive ataxia of Charolais cattle – an oligodendroglial dysplasia. *Veterinary Pathology* 23:78–80
- Davies I H, Munro R 1999 Osteochondrosis in bull beef cattle following lack of dietary mineral and vitamin supplementation. *Veterinary Record* 145(8): 232–233
- De Ley G, De Moor A 1979/1980 Bovine spastic paralysis: results of selective gamma-efferent suppression with dilute procaine. *Veterinary Science Communication* 3:289–298
- Dowling P, Tyler J W, Wolfe D F, Purohit R C, Steiss J E 1991 Thermographic and electromyographic evaluation of a lumbosacral spinal injury in a cow. *Progress in Veterinary Neurology* 2:73–76
- Dutra F, Carlsten J, Ekman S 1999 Hind limb skeletal lesions in 12-month-old bulls of beef breeds. *Journal of Veterinary Medicine Series A* 46(8):489–508
- Edwards R B, Fubini S L 1995 A one-stage marsupialization procedure for management of infected umbilical vein remnants in calves and foals. *Veterinary Surgery* 24(1):32–35
- Griffiths I B 2005 Spastic paresis in calves. *Veterinary Record* 156(24):786–787
- Hill B D, Sutton R H, Thompson H 1998 Investigation of osteochondrosis in grazing beef cattle. *Australian Veterinary Journal* 76(3):171–175
- Heinola T, Karhula H 2002 Osteochondrosis in growing dairy bulls – a case report. *Suomen-Elainlaakarilehti* 108(5):268–272
- Hum S, Kessell A, Djordjevic S et al 2000 Mastitis, polyarthritis and abortion caused by *Mycoplasma* species bovine group 7 in dairy cattle. *Australian Veterinary Journal* 78(11):744–750
- Keith J R 1981 Spastic paresis in beef and dairy cattle. *Veterinary Medicine/Small Animal Clinician* p 1043–1047
- Ledoux J M 2004 Hypothesis of interference to superinfection between bovine spastic paresis and bovine spongiform encephalopathy; suggestions for experimentation, theoretical and practical interest. *Medical Hypotheses* 62(3): 346–353
- Ledoux J M 2001 Bovine spastic paresis: etiological hypotheses. *Medical Hypotheses* 57(5):573–579
- Nayak S, Dey P C, Mohanty J 1999 A simple method of diagnosis and treatment procedure for intra-abdominal navel ill in bovine calves. *Indian Veterinary Journal* 76(1):48–49
- Pavaux C, Saulet J, Ligneux I Y 1985 Anatomy of the bovine gastrocnemius muscle as applied to the surgical correction of spastic paresis. *Vlams Diergeneeskundig Tijdschrift* 54: 296–312

- Pavaux C, Arnault G, Baussier M, Dumont M 1988 Treatment of spastic paresis in cattle with Gottze's technique, triple tenectomy. *Point Veterinaire* 20:41-50
- Scott P R, Rhind S, Brownstein D 2000 Severe osteochondrosis in two 10-month-old beef calves. *Veterinary Record* 147(21):608-609
- Sponenberger D P, Vanvleck L D, McEntee K 1985 The genetics of the spastic syndrome in dairy bulls. *Veterinary Medicine* 80:92-94
- Svensson C, Lundborg K, Emanuelson U, Olsson S O 2003 Morbidity in Swedish dairy calves from birth to 90 days of age and individual calf-level risk factors for infectious diseases. *Preventive Veterinary Medicine* 58(3/4):179-197
- Tarongi A, Philbey A W, Barrett D C, Winden W van 2004 Severe osteochondrosis and rupture of the tuber calcaneus in cattle: a case report. *Cattle Practice* 12(4): 295-297
- Touati K, Muller P H, Gangl M, Grulke S, Peters F, Serteyn D 2003 La paresie spastique du quadriceps femoral: Une nouvelle entite clinique chez le veau de race Blanc Bleu Belge. *Annales de Medecine Veterinaire* 147(4):261-265
- Trostle S S, Nicoll R G, Forrest L J, Markel M D 1997 Clinical and radiographic findings, treatment, and outcome in cattle with osteochondrosis: 29 cases (1986-1996). *Journal of the American Veterinary Medical Association* 211(12):1566-1570
- Tryon K A, Farrow C S 1999 Osteochondrosis in cattle. *Veterinary Clinical of North America: Food Animal Practice* 15(2):265-274
- Verschooten F, DeMoor A, Steenhaut M, Desmet P, Wouters L, DeLey S 1974 Surgical and conservative treatment of infectious arthritis in cattle. *Journal of the American Veterinary Medical Association* 165:271-275
- Vlaminck L, Moor A de, Martens A et al 2000 Partial tibial neurectomy in 113 Belgian blue calves with spastic paresis. *Veterinary Record* 147(1):16-19
- Washburn K E, Streeter R N, Panciera R J 2003 A review of inherited central nervous system dysfunction in calves. *Bovine Practitioner* 37(1):60-67
- Wells G A H, Hawkins S A C, O'Tool D T et al 1987 Spastic syndrome in a Holstein bull: a histologic study. *Veterinary Pathology* 24:345-353

# An Approach to Controlling Lameness in a Dairy Herd

## KEY CONCEPTS

- A skilled observer can detect 2.5× more lame cows than an unskilled individual.
- Dairy producers seriously underestimate the incidence of lameness.
- Lameness in dairy cows is almost always caused by a claw lesion but a claw lesion does not always cause lameness.
- A cow can have more than one disease (lesion) in one claw causing lameness.
- For every lesion in one foot causing lameness there could be others that may cause lameness in the future in the same foot or in another foot.

## INTRODUCTION

An attending veterinarian will inevitably be called on to treat the occasional lame cow on a farm. The producer may treat other lame animals without mentioning the fact to the veterinarian. Often animals that were lame go unnoticed and untreated. As likely as not, without documented records, the incidence of lameness will be unknown. Therefore, by the time the producer realizes that the herd has a lameness problem it will be a serious one. Another misleading factor is the incidence of digital dermatitis (hairy warts) which may be so prevalent (around 30% of the herd is not exceptional) that it masks other lameness-producing lesions.

The above scenario is not uncommon in large, high-production herds of dairy cows. The information provided in previous chapters should be sufficient to understand and handle cases of lameness in individual cows or lameness events in small groups of dairy cows. In this chapter, bovine lameness will be examined from a holistic perspective. That is to say, to consider all of the risk factors that can collectively produce a negative effect on the foot health of a dairy herd.

Intensively managed cows are subjected to the dictates of human beings (dairy farmers) who are fallible. Furthermore, cows are selectively bred for high production at the expense of 'functional efficiency.' Adding to the complicated mix of risk factors is the ongoing evolution of nutritional practices and management systems. The latter cater to the convenience of man rather than for the comfort of cows.

## THE LAMENESS MANAGEMENT TEAM AND THE HUMAN FACTOR

### KEY CONCEPTS

- The increase in lameness in a herd can be so insidious that the veterinary practitioner can be taken by surprise and possibly be blamed for not acting previously. The solution can be a comprehensive review in which a 'group' investigates 'all' risk factors.
- The 'team' consists of the producer, the veterinarian, the claw trimmer, and the nutritionist or livestock specialist.

## The Dairy Producer

*'He who pays the piper calls the tune.'*

The dairy producer is the person in control. If the advice given is deemed unacceptable, it can be ignored, changed, or a different consultant employed. When a young veterinarian first goes into practice he/she will have very little experience with dealing with human nature at the farm level. Diplomacy and understanding are an important part of a young person's success and making allowances for idiosyncrasies and biases is very important.

For example, farmers are reluctant to introduce measures that will reduce milk production. Some dairy men may insist on maximum production rather than optimal cost effectiveness and more healthy animals. Experience has taught them to be reluctant to pay for advice. Dairy producers are often confused by too much free, sometimes contradictory, advice from different sources. Above all, the young veterinarian must realize that dairy people are understandably sensitive to any implication that they are neglecting their animals or that they are incompetent.

## The Veterinary Practitioner

The veterinarian understands the disease process and is well informed about nutrition and management. For this reason, he/she is the best individual to coordinate the control of lameness in a dairy herd. As with the producer, the veterinarian may be subject to bias.

For example, in some countries the veterinarian may, mistakenly, be of the opinion that the claw trimmer is superseding his/her work or role by diagnosing and treating lame cows. In reality a competent claw trimmer knows the limitation of the claw-trimming profession and will enhance the role of the veterinarian by providing data on the current status of foot health in the herd.

The veterinarian has established a role as leader in the operation of herd health programs for the control of such problems as reproductive inefficiency and mastitis control. Up to the present there has been no recognized protocol for integrating a comprehensive herd lameness protocol into a herd health program. New information on lameness control has exploded in the past few years.

Yet another factor causing reluctant collaboration between professions is a distinct overlap between the work performed by the consultant animal scientist and the veterinarian. This has sometimes led to unnecessary hostility, which is a pity – the contribution of the nutritionist is a critical factor in solving herd lameness problems.

## The Nutritionist

### KEY CONCEPT

- The dairy producer only gets what is paid for.



An independent nutritionist is a highly desirable member of the team. Livestock consultants in the employ of a government agency also fall into this category. However, some nutritionists are hampered by vested interest. They may be part of the sales team of a company selling cattle feed. The farmer may demand a product at the lowest possible price in what is a competitive business. Undercutting the competition is part of the game. This is accomplished by substituting the least expensive commodities while achieving the same ration formulation. This practice can be prejudicial to the foot health of the cow. In the management-team situation, a greater openness is mandatory which is helpful to all members of the team.

## The Claw Trimmer

### KEY CONCEPT

- The claw trimmer is an invaluable resource for providing an ongoing record of the prevalence of claw lesions.

Claw trimming has already been described in Chapter 14. The wellbeing of cows benefits directly from the work of the competent claw trimmer. However, routine claw trimming also means regular monitoring and recording claw health and could result in the accumulation of data that is of considerable benefit to the overall efforts of the herd health program.

The good professional claw trimmer not only manages lameness-causing lesions but can take measures to prevent future claw lesions from developing. The good professional claw trimmer should not cause more lameness after a visit than was present before. Some cows may bleed after treatment, but not excessively so. Also, some cows may have sore feet but this is the exception unless the trimmer is unfamiliar with the condition of the herd and its management system. It is not uncommon that the herd milk yield may drop by as much as 1litre/day/cow for a maximum of 48 hours after a trimming session. This drop is related more to the upset caused by handling and deprivation of water/feed than it does to the stress of the trimming procedure or any foot discomfort they may experience. Often milk yield will rise three days after trimming.

## COORDINATING A COMPREHENSIVE REVIEW OF A HERD LAMENESS PROBLEM

### KEY CONCEPTS

- The key to understanding a problem lies in 'observing the observable.'
- The good investigator is a student of animal (and human) behavior.
- You do not have to be a veterinarian, nutritionist, or claw trimmer to conduct an investigation, but it is essential to have their input.

Epidemiologists usually start an investigation by asking, 'Is there really a problem?' Investigating herd lameness is no exception to this rule but the problem may be difficult to assess as records may be unreliable. The fact that a producer expresses concern about the ravages of lameness in his herd should be taken as an admission of a serious situation demanding prompt action.

Whatever the prior history, it is essential that a computerized database of relevant information be created consisting of at least the following:

- Number of lactations completed by each cow.
- Date of commencement of lactation, i.e., calving date.
- Date of birth.
- Date on which an animal was observed lame.
- Date on which an animal recovered from the lameness. Lameness observed after 28 days in the same cow should be recorded as a new lameness case if the cow has recovered in between.
- Date of observation and description of all lesions.
- Concentrate ration formulation for each animal group and date of change.
- Date of changes in forage fed to each group with notation on type and quality.
- Milk yield for each cow lactation, monthly or daily.
- Records of reproductive performance and the occurrence of other diseases.

Much of this information will be obtainable from cross linkage with other herd-health/production databases. An increase in the prevalence of diseases other than those causing lameness is a clear indication that common stressors are present.

During the data analysis stage, it will be appropriate to relate causal lesions to differences in 'treatment' (management and nutrition) of the following management groups (maximum 10 per cohort):

- Heifers 0–4 months before calving.
- Heifers immediately after calving.
- Mature lactating cows subdivided into any appropriate management groups or strings.
- Dry cows.

Throughout every stage of the investigation, it is wise to examine observations and data applicable to animals from each 'treatment group.'

## SUGGESTED PROTOCOL FOR ESTABLISHING THE CURRENT STATUS OF THE HERD

### KEY CONCEPT

- The objective for the investigation is to make recommendations and motivate the producer to implement them.

In order to motivate a producer to implement recommendations, it is important that he/she be the important player in collecting data, observing, and recording risk factors. This must be carried out with the support and encouragement of the other advisors in the team. It is unreasonable to expect a producer to implement a recommendation on the say-so of the 'expert.' The producer needs to be convinced about the facts on which the recommendation is based.

## Recommended Activities for the Team

### Observe the Herd Unit in Normal Operation

When time and opportunity permit it is useful for the attending veterinarian to observe the herd unit in normal operation. If more than 25% of the cows are standing (1 hour after milking), it is likely that there is a significant problem with cow comfort (design of the housing facilities; p. 71). This matter will be studied fully later in the investigation. In a free stall (cubicle) system, this is also an opportunity to evaluate how the cows are lying in respect to the size and apparent comfort of the stalls

(p. 74). It is important to note the prevalence of rumination and if the number of animals ruminating differs between the groups (pp. 61 and 71). This is also a good opportunity to examine the consistency of the manure, which also may differ between groups (pp. 56 and 66). There may be an opportunity to observe the length of time cows spend in the holding yard (p. 73). Seeing is believing.

### View Each Group of Cows at Standing Rest

Viewing each group of cows at standing rest provides an excellent opportunity for the 'team' to spend time having an educational experience. Body condition, cleanliness of the cows, and physical injuries can be quietly reviewed. The prevalence of hardship grooves and puffy feet should be noted for future reference. The posture of the cows may give a general picture of the characteristics of any discomfort the animals are experiencing (p. 31). For example, if the majority of cows stand camped back without showing a high prevalence of definable lameness they probably are affected with either heel erosion, sole ulcers or digital dermatitis.

### View Lactating Cows Walking on Concrete

Next the team should view lactating cows walking on concrete. Reported lameness is usually less than actual lameness. It is useful to determine the true percentage of cows in a herd that are lame. Hopefully, the claw trimmer will already have determined how many cows have lesions that could cause lameness. Comparing the number of cows actually lame with the total number of lesions can estimate the prognosis for the herd. The claw trimmer will record the relative significance of digital dermatitis and laminitis-related lesions. Even if the prevalence of digital dermatitis is high, the lesions associated with laminitis-related disorders may be of greater importance. Digital dermatitis also stimulates heel-horn production, thereby increasing claw overload and the risk of subclinical laminitis.

### Lift the Limbs and Examine the Claws

The objective of the three first activities is for the team to become familiar with the herd and how it is managed. Cows with locomotion problems will have been identified. Under ideal circumstances the feet of the majority of the cattle in the herd should already have been examined by claw trimmer. Nevertheless, it may be appropriate to lift the limbs and examine the claws of any cows noted in the forgoing stages of the investigation. If a significant number of hardship grooves have

been observed, measurements should be made at this time.

### The Walk Around

#### KEY CONCEPT

- What one is told is not always a fact, i.e., true. It may be what one is not told that is important.

This is the time for the investigators to use their senses of sight, smell, and touch. It is the time to ask questions. Does the same person always mix the feed? What happens at the weekends? This is a quest of verification and a time for observation.

Is the silage in good condition? Is the length of cut suitable? Does it feel, look, and smell right? Do all the sources of hay appear, smell, and feel to be of the same quality? Is there damage to the feed from the elements?

Occasionally one may be surprised to find a pile of previously unmentioned feed such as brewers' grains or a similar by-product. Sometimes, reserve forage, different in quality from the rest, may be located in the fields.

At this time, the supply of the concentrate component of the ration should be reviewed. If everything is supplied directly by a feed mill, there is little to do but to examine the suitability of the storage facility. However, if it is sensed that the supplier is under a price constraint, it may be useful to examine the product closely and note the identifiable components. Perhaps a commercial premix is combined with home grown feedstuffs. This provides a time for potential errors to occur.

If a total mixed ration (TMR) is used, the process of mixing should be evaluated particularly for consistency (p. 61).

### Other Factors

If data is available, milk fat inversion and somatic cell count might be reviewed. Only in extreme instances will it be necessary to systematically study fluctuations in rumen pH (rumenocentesis; p. 58).

## REVIEW RISK FACTORS AFFECTING BEHAVIOR ASSOCIATED WITH BUILDINGS

#### GLOSSARY

**Risk Factor:** In the context of subclinical laminitis a risk factor can be defined as 'any circumstance that has a negative effect on the metabolism of an animal.' There is an enormous range of risk factors, most of which involve the intensive-management technologies required for high levels of milk production.

Britt (1993) developed a system to quantify cow comfort. Using this system as a guide, Tables 19-1 and 19-2 were adapted and developed for use in this book as an arbitrary protocol for looking at risk factors. There is no proven method for scoring the significance of each risk factor. The greatest benefit will result if the producer can be motivated to take the lead in this part of the evaluation.

## GROUP DISCUSSION OF THE DATA AVAILABLE

#### KEY CONCEPT

- If lesions associated with subclinical laminitis (white line disease, toe and sole ulcer) are present in 10% of the animals in a group, it will be assumed that the probability of subclinical laminitis existing in that group is high.

## REVIEW THE LESIONS

#### KEY CONCEPT

- Hemorrhages in the sole must never be considered alone as a clinical sign of subclinical laminitis. They can sometimes be an indicator of the severity of the disorder (pp. 41 and 222).

Table 19-1

REFUSAL TO USE FREE STALLS				
Risk Factor		Interpretation of Significance of a Risk Factor		
1	Stall size	1.2m × 2.4m Less than 1.2m × 2.4m	Probably optimal Ascribe a negative score taking into consideration restrictions imposed by partitions	0 -1 to -5
2	Lunge space	Over 1m with brisquet board Less than 1m	Probably optimal If there is neither brisquet board nor any lunge space ascribe a high negative score	0 -1 to -5
3	Bedding	10cm deep with clean sand	Warrants a high positive score but only if not contaminated	3-5
		Mattress/ rubber mat 5cm straw/sawdust on concrete base	Warrants a positive score Probably adequate	1 to 3 0
		Less than 5cm with bare concrete showing	Ascribe a negative score	-1 to -5
4	Care of bedding	Clean, dry, and evenly distributed	Optimal situation	0
		Presence of manure or urine, bedding piled to the front and uncared for appearance	Ascribe a negative score appropriate for the estimated degree of negligence	-1 to -5
5	Use of stalls	98% of cows use stalls Less than 98% of cows use stalls	A highly positive attribute This is an important but difficult observation to make and depending on the finding can be a highly negative finding	+5 0 to -5
6	Width of alley. The distance between the curb of the stall and that on the other side of the barn or the distance between the curb on one side and the feed bunk on the other	3.7m wide	The wider the greater should be the positive score. The narrower the more negative should be the score	0
		Less than 3.7m wide Greater than 3.7m wide		-1 to -5 1 to 5
7	Ratio of cows to stalls	Equal number of stalls to animals	Barely acceptable	0
		More stalls than animals	Preferred	1 to 5
		Fewer stalls than animals	Very unacceptable	-1 to -5
8	Ratio of cows to bunk spaces	Equal number of cows to spaces	Barely acceptable	0
		Fewer spaces than animals	Very unacceptable	-1 to -5
		More spaces than animals	Preferred	1 to 5
9	Size of feed bunk space	0.6m per cow	Equal or greater space Less space	0 -1 to -3
TOTAL SCORE FOR THIS RISK FACTOR				

Table 19-2

FACTORS THAT INCREASE STANDING TIME OR SOLE TRAUMA				
Risk Factor		Interpretation of Significance of a Risk Factor		
1	Cows in holding pen	Up to 3 hours per day More than 3 hours per day	Acceptable Very undesirable	0 -1 to -5
2	Surface of holding pen	Ungrooved concrete Grooved concrete Rubber covered Hosed down more than once during milking	Unacceptable Acceptable Excellent Highly desirable	-1 to -3 0 1 to 5 1 to 2
3	Claw trimmer	Routine as needed Feet never need trimming Rarely use services of trimmer	Desirable Unusual Undesirable	5 5 -1 to -5
4	Concrete surfaces	Smooth, wet, and filthy Grooved and regularly scraped Rubber surfacing and regular cleansing	Very undesirable Desirable Highly desirable if there is a concurrent claw trimming program	-1 to -5 1 to 3 4 to 5
5	Water supply	Water bowls Ideal if one watering station per 10 cows or 0.62m of trough space for every 10 cows  Located in crossover alleys within 20m of the feed bunk Seen to cause social confrontation or queuing	Unacceptable If ideal If better than ideal If less than ideal Desirable  Undesirable	-3 0 1 to 3 -1 to -5 1 to 3  -1 to -5
6	Computerized feeders	Sufficient number to avoid queuing	Little or no queuing Regular queuing	0 -1 to -5
TOTAL SCORE FOR THIS RISK FACTOR				

Cows can have several different lesions even in one claw. Any one of the three lesions associated with subclinical laminitis (white line disease, toe and sole ulcer) present in any degree of severity should be regarded as significant. In this consideration, lameness may or may not be present; it is the lesion that is important. However, only one lesion is required for the finding to be evaluated as significant.

In the past, workers have included 'sole hemorrhages' as a typical sign associated with subclinical laminitis (SCL). It is recommended that sole hemorrhages should not be considered at this stage. Hemorrhages and bruises are difficult to differentiate and are a relatively common finding that might skew data. Having said this, the prevalence of hemorrhages should be noted within each group that meets the 10% SCL-associated lesion requirement.

Sole hemorrhages are an important clinical sign within each treatment group. However, interpretation of the sign is arbitrary and based to some extent on circumstantial evidence. For example, if there is a history of the animals being moved from a soft pack to a hard surface several

weeks before the time the hemorrhages were observed, bruising should be considered to be a significant contributory cause. Cattle walking some distance on hard roads might fall within the same category. Standing for abnormally long periods should also be taken into consideration. SCL may exist but trauma is a precipitating factor.

On the other hand if there is no pressing circumstantial evidence to indicate there has been abnormal claw trauma it may be concluded that if hemorrhages are present they provide supporting evidence about SCL.

The evaluation of the clinical data should be conducted in respect to each of the animal groups selected at the commencement of the investigation.

### Heifers 0 to 4 Months Before Calving

Very few heifers are likely to show lesions associated with laminitis before they calve for the first time. If they do, it would be a serious indication that early rearing practices need to be carefully reviewed. Furthermore, if

hemorrhages are present and there is no history of moving from soft to hard surfaces, management practices and/or nutrition are very likely to be at fault.

## Heifers During the First Lactation

It is becoming more common for heifers reared in very high-producing herds to show a high prevalence of hemorrhage shortly after calving. They may go on to show a prevalence of lameness-producing lesions during peak lactation. Sometimes the prevalence of lameness may be higher than in mature cows. When this is the case, several possibilities should be reviewed:

- Is there an acclimatization period for the heifers when they are transferred from a soft surface to concrete? Does this occur at the same time there is a significant ration change?
- Are the heifers suddenly introduced into a group of mature cows? This can be quite stressful if the available space is sufficiently restricted to cause strong competition. The initial confrontations can be significantly reduced if several heifers are introduced to the main group at the same time during the late evening when it is dark.
- Are the animals overcrowded? Are there enough bunk spaces and stalls? Are the heifers standing for longer periods than the cows?
- Are the heifers, on average, calving earlier than 24 months of age?

## Mature Cows

Mature cows may have been subdivided into management groups (strings) according to their stage of lactation. Group management of a herd is often related to the size of the herd. For herds up to 100 head, group management is difficult. If cows show a good persistent lactation curve and if calving intervals are kept within reasonable limits (less than 400 days) there is no need to introduce a group management system.

One objective of string management is to have all of the animals in the group roughly at the same stage of lactation, thus enabling the manager to formulate different rations to support the periods of particularly high production and to provide less energy for animals during less productive periods of the lactation.

Comparing the incidence of lesions causing lameness within each group helps to determine the cause. The appearance of lesions normally peaks 60–80 days after calving. If there is a preponderance of lameness earlier or later in the lactation other factors than calving management must be investigated.

A further objective of group management is to control body condition score by restricting dietary energy through the creation of low nutritional level groups.

## REVIEW HARDSHIP GROOVES (IF PRESENT)

### KEY CONCEPTS

- Is a hardship groove (or changed band of wall horn) present at the same location on the claw wall in 10% of the cows?
- Is a hardship groove (or changed band of wall horn) present in 10% of the cows but at different distances from the hair line?
- A hardship groove is an historical indication of a period of stress and not necessarily an indicator of SCL.
- A band of raised horn (ridge) is indicative of an overall improvement in the diet.

Evaluating the significance of a hardship groove is not an exact science, but it is another tool that may contribute to understanding the stresses to which a herd has been subjected:

- Groove in the same location* in 10% of cows suggests that the same insult occurred at the same time. It is a sign that some sort of stressor, probably a sudden change in nutrition, occurred at a particular time. See Figure 16-37 for information on how to use a hardship groove to determine when an insult occurred. A band or ridge of horn, differing in appearance from that elsewhere on the wall, suggests that a major change in nutrition has occurred which may or may not be associated with an episode of SCL.
- Groove in a different location* in 10% of cows indicates that an insult took place at different times. The cause of the groove might be a hard calving, acute mastitis, or even a septic arthritis in the pedal joint. However, if the grooves were formed around the time each cow calved, this is a clear indication that the management during the period around calving should be reviewed.

## Dry Cows

The body score of the dry cows should be reviewed and their nutrition adjusted if deemed necessary. It can be extremely dangerous to try to get a dry cow to lose weight. The loss of body fat resulting from a too restrictive diet can result in liver steatosis before parturition. If this happens the transition period becomes a nightmare – downer cows, delayed uterine involution, metritis, and ketosis may occur.

Is the housing of the dry cows is different from the lactating cows? If it is, is the behavior of the cows in each group different? Do the dry cows spend enough time lying and ruminating?

The appearance of the manure of the dry cows is likely to be different from that of lactating cows. Can anything be learned from this difference? For example, there could be a different quality of fiber used for each group and a sudden change just before calving could cause a problem at the time when the amount of carbohydrate is also being increased.

## REVIEW NUTRITION

### KEY CONCEPTS

- A nutritionist may formulate an ideal ration; a producer may modify it to save expenses; a cow may consume selected portions of the feed if she is given the opportunity.
- Many veterinarians are extremely competent nutritionists. However, within the context of herd investigation, his/her role is that of a 'trouble shooter.'

It is counterproductive for a veterinarian to criticize the suitability of a ration formulated by a professional nutritionist. The nutritionist's role is to advise on the ration that will provide optimal, cost-effective production. A management policy that has been agreed as the result of group discussion has the best chance of being implemented.

## Energy

In any operation there is always the possibility that cows will receive more energy than they need. However, this is unlikely if the formulation is devised by a professional

nutritionist and faithfully adopted by the producer. Overzealous dairymen may 'adapt' the ration as a means of mistakenly improving on the recommendations of the consultant. These occasions are rare and should be easily identified.

High levels of energy can be fed inadvertently. The most common cause is underestimating the contribution of carbohydrate made by corn silage. This can be suspected if the cobs appear too rich in grain (see p. 62).

Producers may opt to feed a high production TMR. This is fine if introduced gradually to high-production cows. Nor is this process a problem if a different TMR is fed to groups (strings) of animals according to their production. This practice is inconvenient if the herd is a small one. In these cases, the dairy manager may opt for a TMR that provides something more than maintenance and offers additional concentrate in the parlor to high-producing cows. Problems may be encountered during the transition feeding period.

## Fiber

Many of the nutritional problems with dairy cows are associated with the effective fiber component of the ration. This is more likely to occur the closer the concentrate to forage ratio approaches 60:40. Inadequate chop length of silage can significantly drop the effectiveness of the fiber. Changes in the quality of the effective fiber between two sources of forage may be difficult to identify in retrospect.

## Other Factors

During the physical evaluation of the storage of feedstuffs any suspicious findings should be discussed.

## EVALUATE THE LEVEL OF COW COMFORT (STRESS)

In practice it has been found that simply reducing the population density in a herd can bring about a dramatic reduction in the prevalence of lameness. In Italy it has been postulated that if cows can have sufficient rest and do not suffer from damaged claws caused by poor floors the influence of nutrition will be a much less important cause of lameness. The balanced view is that lameness is a 'multifactorial' problem. Any combination of risk factors can cause problems.

However, evaluating cow comfort should start with the assumption that problems with cow comfort do not, alone, cause lameness. Cumulative problems lead to stress,

and stress is believed to affect the immune system. This may be sufficient to make an animal more susceptible to disease. At the same time, there is increasing evidence that stress may play a part in the pathophysiology of laminitis.

A review based on the factors listed in Tables 19-1 and 19-2 is not intended to provide an empirical answer. They are intended to be a tool to create understanding and awareness of factors that can be detrimental to the health of a herd of dairy cows. Recommending major changes in the layout of a building may be beyond the financial resources of the producer. It may be sufficient if the dairy manager agrees that one or more negative risk factors probably exist.

---

## CONCLUSIONS

All of the answers to the herd lameness problem are not yet known. Investigating a herd problem is comparable to a detective solving a crime. What you don't see you cannot use as evidence. An investigator may have a hunch but be unable to prove it. Furthermore, a veterinarian must appreciate that problem solving is as much a matter of manipulating human nature and accommo-

dating human pride as it a matter of scientific investigation. It is relatively easy to make a dairy manager resistant to any information if it is hinted that lack of skill might be involved. A friendly team approach has much merit.

The approach suggested in this chapter must be interpreted and implemented with discretion. This approach has been developed as much on experience as on scientific data and is presented as a 'best guess' guideline for dealing with herd lameness in the field. So, what should be done when facing an acute herd lameness crisis?

- *Trim the whole herd.* This way all cows with lameness-producing or potentially lameness-producing lesions will be treated at one time. Cows that would become lame weeks or months in the future are saved a great deal of suffering.
- *Start a foot bathing program.* Once open defects of the claw capsule have been properly treated foot bathing is the most effective way of controlling many diseases and disorders.
- *Start a systematic investigation of the problem.* Always bear in mind that an investigation should be an educational experience and that creating an awareness of key concepts contributes to problem solving.



# Index

## A

Abaxial collateral ligament, 245  
Abaxial surface, 241  
Abscess  
    retroarticular, 95, 201, 261–3  
    sole, 224–5  
    toe, 96, 100–2, 245  
    white line, 225–8  
Acetabulum, 278  
Acid detergent fiber, 58, 111  
Acquired traits, 143  
*Actinomyces pyogenes*, 220  
Acute laminitis, 37–8  
    cause, 38  
    description, 37  
    hindlimb vein engorgement,  
    37  
    treatment, 38  
Age, 72  
Amputation of digit, 254–5  
Angle grinder, 193, 194  
    cutting disks, 193–4  
    grinding disks, 194, 195  
Angularity, 148–9  
Animal welfare, 3–4  
Ankylosing spondylitis, 279  
Ankylosis, 278  
Antibiotics  
    foot baths, 186  
    regional intravenous perfusion,  
    252  
    sprays, 187  
Antiphlogistine, 285  
Arthrocentesis, 246

Arthrodesis, 252, 255–61  
    direct ablation of pedal joint, 255–7  
    resection of deep flexor tendon and  
    removal of navicular bone,  
    257–61  
Arthropathy, 278  
Arthroscopy, 246, 278  
Aspartate aminotransferase, 159  
Auscultation, 278  
Axial groove, 232  
Axial surface, 241  
Axial wall fissures, 232–3

## B

*Bacteroides capillosus*, 211  
*Bacteroides fragilis*, 211  
*Bacteroides melaninogenicus*, 202  
Bail, 107  
Bandaging, 195  
Barn management, 81–2  
Bearing surface, 177  
Bedding, 77  
Beef cattle, 138  
    conformation, 152–3  
Bilirubinuria, 159  
Bioavailability, 125  
Biotin, 131  
Blind fowl, 200–1  
Blood sampling, 127  
Body depth, 148  
Bog spavin, 284  
Bones  
    cannon, 241  
    fetlock *see* Fetlock

    navicular, 242, 243, 257–61  
    pastern, 242  
    pedal *see* Pedal bone  
*Borrelia* spp., 211  
Bovine bootie, 186, 187  
Brisket board, 76  
Broken back, 279–80  
Bruising, 221–4  
    cause, 223  
    control, 224  
    description, 221–3  
    treatment, 223  
Brush marks, 222  
Buckled claw, 176  
Buffers, 64  
Bumble foot, 254  
Bunk  
    availability of feed in, 73  
    management, 66  
    space size, 78

## C

Calcium  
    and foot health, 130  
    recommended dietary level, 127  
    in water, 121  
Calves  
    beef herds, 6  
    contracted tendons in, 289  
    neonatal polyarthritis, 289–90  
Calving, management after, 65  
Camping back, 29, 30  
Camping forward, 29, 30, 31, 97  
Cannon bone, 241

- Capacity, 147
- Carbohydrates, 60  
non-structural, 55  
supplementation, 114
- Carpal hygroma, 286
- Chemical fiber, 60
- Chemical restraint, 188
- Chest width, 147–8
- Chronic laminitis, 49–50  
cause, 49  
description, 49  
treatment and control, 50
- Classification of lameness, 34
- Claw, 8–28, 241  
arteriovenous anastomosis, 25  
bearing surface, 177  
buckled, 176  
centre of gravity, 176  
claw segments, 13–19  
bulb of heel (bulbar segment), 18–19, 244  
coronary band (perlople segment), 13–14, 244  
coronary cushion (pulvinus limbi), 19, 244  
lamellae (wall segment), 16–17  
sole (solear segment), 17–18  
wall (coronary segment), 14–16  
white line (zona alba), 19  
concavity, 173  
corkscrew, 237–40  
dew claws, 241  
digital cushion (pulvinus digitalis), 22–3  
diseased, 182–3  
epidermis, 9–10  
examination of, 298–9  
flow of forces through, 23–4  
horn quality, 46–7  
living epidermis, 10–12  
maintenance of pedal bone  
position, 19–22  
pedal bone support system, 19–22  
suspensory apparatus of digit, 19  
microvasculature, 25–7  
overloading of sole, 47, 171, 172, 221  
pad, 177
- Claw capsule, 241  
disorders of, 84–106  
double sole, 102–4  
sole ulcer (pododermatitis septica circumscripta), 84–9, 245  
toe abscess, 96, 100–2  
toe ulcer, 95–100  
under-run heel, 105  
white line disease, 89–95  
fractures, 268–70
- Claw diagonal, 174
- Claw morphology, 171
- Claw trimming, 88, 170–83, 297  
diseased claw, 182–3  
equipment used in, 189–95  
frequency of, 179  
functional, 171–2  
for lateral stability, 177–9
- Club foot, 254
- Cobalt  
and foot health, 129  
recommended dietary level, 127
- Cocked toe, 86
- Cold, 71
- Compartment syndrome, 159
- Component feeding, 55, 66
- Concrete floors, 80  
acclimatization to, 80–1
- Concrete hock, 284–6
- Conditioning, 125
- Conformation, 141, 142, 152–3
- Control of lameness, 295–304  
comprehensive review, 297–8  
cow comfort, 303–4  
establishment of current status, 298–9  
group discussion, 299  
hardship grooves, 302–3  
lameness management team, 296–7  
claw trimmer, 297  
dairy producer, 296  
nutritionist, 296–7  
veterinary practitioner, 296  
nutrition review, 303  
review of lesions, 299, 301–2  
risk factors, 299, 300–1
- Copper, 116  
and foot health, 128–9  
recommended dietary level, 127
- Copper sulfate, 186
- Corkscrew claw, 237–40  
cause, 238  
control, 239–40  
description, 237–40  
treatment, 238–9
- Cornification, 8
- Corn (maize) silage, 62–4  
conservation methods, 63–4  
harvesting, 62–3  
milk line, 62, 63
- Corns *see* Interdigital hyperplasia
- Coronary band (perlople segment), 13–14, 244
- Coronary cushion (pulvinus limbi), 19, 244
- Corynebacterium pseudotuberculosis*, 211
- Cow-calf beef herds, 6
- Cow comfort, 70, 303–4
- Cow comfort index, 71
- Cow hock position, 33, 146, 173
- Crawlers, 33
- Creatine kinase, 159
- Creepers, 155, 157, 158
- Crepitation, 278
- Crossing feet, 32
- Cruciate ligament, 245, 246  
rupture, 283
- Crush (chute), 189–92
- Cryosurgery, 275
- 
- D**
- Deep flexor tendon, 244  
resection of, 257–61
- Degenerative arthropathy, 280–1
- Degenerative joint disease, 280–1
- Degloving injuries, 268, 271–2
- Demi solea, 3
- Descriptive traits, 151
- Desmosomes, 8
- Dew claws, 241
- Dichelobacter nodosus*, 202, 205, 207, 211
- Digital cushion (pulvinus digitalis), 220–3, 244
- Digital dermatitis, 183, 208–13  
cause, 210–11  
description, 208–10  
differential diagnosis, 211  
history, 208  
treatment, 212–13
- Distal annular ligament, 245, 246
- Distal interphalangeal joint *see* Pedal joint
- Distal interphalangeal ligament, 243, 245
- Dominance, 72
- Dorsal flexure, 241
- Dorsal surface, 241
- Double Action, 186
- Double sole, 102–4  
cause, 103  
description, 102–3  
treatment, 104
- Downer cows, 155–63  
appearance of patient and environment, 156  
blood evaluation, 159  
compartment syndrome, 159  
creepers, 155, 157, 158  
electromyography, 160  
evaluation, 156–9  
fractures, 159  
hip dislocation, 158, 159  
history, 156

- Downer cows (*cont'd*)  
 hypocalcemia, 157  
 pathetic appearance, 157, 158  
 prevention, 161  
 treatment, 160–1  
   animal care, 160  
   lifting the cow, 161, 162  
   medication, 160  
   nursing, 160–1  
   ultrasonography, 160  
   young animals, 157
- Drawer sign, 283
- Drifting, 108
- Dropped hock, 165
- Dry cows, 303  
 management, 64–5
- Dysplasia, 278
- 
- E**
- Economics, 4
- Electromyography, 160
- Elso heel, 292–3
- Endotoxins, 45–6
- Epidermal growth factor, 47
- Epidermis, 9–10  
 living, 10–12
- Epistaxis, in SARA, 57
- Equipment, claw trimming, 189–95
- Ethylenediamine dihydroiodide, 204
- Eutrofication, 120
- Exostoses, 241, 278
- Extensor process, 243, 244
- Exungulation, 268
- 
- F**
- Farmer skills, 82
- Feeding behavior, 67
- Feeding pad, 107
- Feedlot cattle, 6  
 acute laminitis in, 37
- Feed rations  
 acid detergent fiber content, 58  
 after calving management, 65  
 availability, 73–4  
 carbohydrates, 60  
 color differences, 58  
 component feeding, 55, 66  
 corn (maize) silage, 62–4  
 dry cow management, 64–5  
 feeding behavior, 67  
 feel of, 58  
 forage, 60–2  
 lead feeding (steaming up), 65  
 manure watching, 66  
 poor feed delivery and bunk  
 management, 64  
 protein, 64  
 rumen modifiers, 64  
 sorting, 62  
 supplementary buffers, 64  
 total mixed ration, 66–7  
 trace elements in, 127–8
- Femoral paralysis, 166–7
- Femorotibial instability *see* Cruciate  
 ligament
- Fetlock, 242  
 flexing, 168  
 flexor annular ligament, 245  
 knuckling, 165, 168
- Fiber, 303
- Fibroma *see* Interdigital hyperplasia
- Fillers, 131
- Fissures  
 axial wall, 232–3  
 horizontal, 39, 233–7  
 vertical, 228–32
- Flexor annular ligament, 245
- Flexor process, 243, 244
- Flexor surface, 241
- Flight zone, 72, 137
- Flipping table, 192
- Floors  
 concrete, 80  
 profiling, 81  
 properties, 78–81  
 rubber, 78, 79  
 slatted, 71, 79  
 stalls, 77
- Foam (for foot baths), 186
- Foot, 143, 241  
 angle, 143–4, 145  
 bumble, 254  
 club, 254  
 crossing, 32  
 lesions, recording, 5  
 puffy, 38, 65, 138  
 slipper, 49
- Foot baths, 183–6  
 design, 184–5  
 digital dermatitis, 212–13  
 prevention of foot rot, 204  
 solutions, 185–6
- Foot and mouth disease, 201
- Foot rot, 199–205  
 cause, 202–3  
 description, 200–1  
 differential diagnosis, 201–2, 211,  
 261  
 history, 199  
 prevention and control, 204–5  
 treatment, 203–4
- Forage, 60–2  
 chemical fiber, 60  
 particle size, 61–2  
 physical fiber, 60  
 supplementary, 114
- Forced standing time, 72–4
- Foreign body, 224–5
- Forelimb  
 analgesia injection sites, 251  
 closure times, 143
- Formalin, 185–6
- Fractures  
 claw capsule, 268–70  
 downer cows, 159  
 pedal bone, 32, 264–6  
   pathophysiological, 266–8  
   traumatic, 264–6  
 use of methyl methacrylate in,  
 269–70
- Frame, 147
- Front foot lameness, 31
- Functional non-production traits, 141
- Fusobacterium necrophorum*, 202
- 
- G**
- Gait, 29  
 normal, 30–1  
 walking narrow, 31
- Gastrocnemius muscle/tendon rupture,  
 287–8
- Genetic selection, 141–54  
 acquired traits, 143  
 functional non-production traits, 141  
 linear-type traits, 141
- Glutamic oxaloacetic acid, 159
- Grinder/mixers, 131
- 
- H**
- Hair samples, 127
- Hanging leg lameness, 32
- Hardship grooves, 39, 233–7, 302–3  
 cause, 237  
 control, 237  
 description, 233–6  
 immature animals, 233  
 mature animals, 234–6  
 treatment, 237
- Heart girth, 147
- Heat stress, 71
- Heel  
 bulb of, 18–19, 244  
 depth, 144  
 erosion, 88  
 height, 174  
 overburdening, 33, 146, 171, 173  
 under-run, 105
- Heel horn erosion, 213–17  
 cause, 214, 217  
 description, 213–16  
 differential diagnosis, 214  
 prevention, 217  
 treatment, 217

Heel overburdening, 33, 146, 171, 173, 174

#### Heifers

- 0-4 months before calving, 301-2
- during first lactation, 302
- exercise, 138
- nutrition, 137

Hematoma, 286-7

Herbicides, 122

Heritability, 150

Hind foot lameness, 31

#### Hindlimb

- analgesia injection sites, 251
- closure times, 143

Hip clamps, 162

Hip dislocation (coxofemoral luxation), 158, 159, 281-3

- treatment, 282-3

#### Hock

- concrete, 284-6
- cow hock position, 33, 146, 173
- dropped, 165
- puffy, 284, 285

Holding area, 73

Hoofnack, 189

Hoof testing calipers, 226

Horizontal fissures *see* Hardship grooves

#### Horn

- overgrowth, 86
- quality, 46-7
- samples, 127
- see also* Claw

Horn defects, 182

- open and closed, 183

#### Housing

- bedding, 77
- brisket board, 76
- bunk space size, 78
- floor properties, 78-81
- individual feed stalls, 78
- lunge space, 76
- space sharing design, 75
- stall dimensions and features, 74-5
- stall floor surfaces, 77
- suitability of, 74-81
- traditional feed stalls, 78

#### Husbandry

- digital dermatitis, 213
- foot rot, 204-5
- interdigital dermatitis, 207

Hydraulic pincers, 193, 194

Hygiene, 81-2

Hypocalcemia, 157, 159

Hypokalemia, 159

Hypophosphatemia, 159

Hypostasis, 101

#### Immunization

- digital dermatitis, 213
- foot rot, 204
- interdigital dermatitis, 207
- Incidence of lameness, 35

#### Infection

- pedal joint, 252-61
- see also* Abscess

Infraspinal tendon, 249

Intensive dairy production, 5

Intercarpal compartment, 249

Interdigital dermatitis, 183, 205-7

- description, 205-7
- differential diagnosis, 207, 211
- prevention, 207
- treatment, 207

Interdigital hyperplasia, 207, 273-6

cause, 273-4

- description, 273
- prevention, 276
- treatment, 274-6

Interdigital space, 241

- conditions of, 199-220
- digital dermatitis, 208-13
- foot rot, 199-205
- heel horn erosion, 213-17
- interdigital dermatitis, 205-7

#### Iodine

- and foot health, 130
- recommended dietary level, 127

#### Iron

- and foot health, 129
- recommended dietary level, 127
- in water, 121

Ischemia, 101

Ischiadic paralysis (sciatic paralysis), 164-5

## J

Joint entry sites, 246-9

#### Joints

- degenerative disease of, 280-1
- metatarsophalangeal, 242
- pedal *see* Pedal joint
- proximal interphalangeal, 242
- stifle, 247

## K

Keratinization, 8

Keratinocytes, 130

Ketonuria, 159

Knee cap dislocation (patellar luxation), 283-4

Knives, 192-3

Knuckling of fetlock, 32

## L

Lactating cows, walking on concrete, 298

Lamellae, 244

#### Lameness

- clinical importance of, 3
- economic importance, 4
- front foot, 31
- hind foot, 31
- historical aspects, 2-3
- and reproductive efficiency, 4-5
- Lameness management team, 296-7
- claw trimmer, 297
- dairy producer, 296
- nutritionist, 296-7
- veterinary practitioner, 296

Lamina fibroreticularis, 11

Laminitis syndrome, 33, 36-54

- acute laminitis, 37-8
- chronic laminitis, 49-50
- claw capsule disorders, 84-106
- history, 36
- pathology, 50-2
- subacute laminitis, 38-40
- subclinical laminitis, 40-9

Lateral stability, 177-9

Lead feeding (steaming up), 55, 65

Legs, 143

Lifting, 161, 162

Lifts, 88-9, 95, 195-7

#### Ligaments

- abaxial collateral, 245
- cruciate, 245, 246
- rupture, 283
- distal annular, 245, 246
- distal interphalangeal, 243, 245
- flexor annular, 245
- proximal annular, 245, 246

Linear-type trait, 141

Listlessness, 156-7

Liver biopsy, 127

Load, 171

Loafing areas, restriction of, 74

Locomotion, 151-2

Longevity, 149-50

Lunge space, 76

## M

#### Magnesium

- and foot health, 130-1
- recommended dietary level, 127

Magnesium oxide, 64

#### Manganese

- and foot health, 129
- recommended dietary level, 127

Manure watching, 66

Matrix metalloproteinases, 10, 11, 47

Mature cows, 302

- Metatarsophalangeal joint, 242
- Methyl methacrylate, 98, 268–71  
 claw capsule and pedal bone fractures, 269–70  
 neglected trauma to claw, 270, 271  
 protection of toe ulcer, 270, 271  
 use of, 269
- Microcirculation, 25–7  
 changes in, 46
- Micronutrient supplements, 125–33  
 grinder/mixers, 131  
 requirements of cow, 126–7  
 trace elements in feed, 127–8  
 trace element status, 127  
 vitamins, 131
- Milk fat:protein inversion, 57
- Milking yard, 111
- Milk line, 62, 63
- Molybdenum  
 and foot health, 129  
 recommended dietary level, 127
- Monensin, 116
- Mortellaro's disease *see* Digital dermatitis
- Musculoskeletal dysfunction, 281–93  
 carpal hygroma, 286  
 contracted tendons in calves, 289  
 cruciate ligament rupture, 283  
 gastrocnemius muscle/tendon rupture, 287–8  
 hematoma, 286–7  
 hip dislocation (coxofemoral luxation), 281–3  
 knee cap dislocation (patellar luxation), 283–4  
 neonatal polyarthritis, 289–90  
 peroneus tertius muscle rupture, 288  
 serous tarsitis, 284  
 spastic paresis (Elso heel), 292–3  
 spastic syndrome, 290–2  
 tarsal cellulitis, 284–6
- 
- N**
- Navicular bone, 242, 243
- Navicular bursa, 244
- Necrosis, 101
- Neonatal polyarthritis, 289–90
- Nerve block, distal digital, 250–1
- Neutral-detergent fiber, 111, 112  
 effective, 111  
 physical, 111
- Nitrates, in water, 121–2
- Nitrogen-boosted pastures, 112
- Noise, 82
- Non-structural carbohydrates, 55
- Normal gait, 30–1  
 protraction phase, 31  
 retraction phase, 31  
 weight-bearing phase, 30
- Nutritional risk factors, 55–69  
 subacute ruminal acidosis, 44–5, 56–8
- Nutritionist, 296–7
- Nutrition review, 303
- 
- O**
- Observation of herd, 298
- Obturator paralysis, 165–6
- Oligofructoses, 113
- Osteochondritis, 278
- Osteochondritis disicans, 280–1
- Osteochondrosis, 278, 280–1
- Overburdening of heel, 33, 146, 171, 173, 174
- Overgrowth  
 disproportionate, 174, 178  
 proportionate, 174, 175
- Overloading, 47, 171, 172, 221
- 
- P**
- Pad, 177
- Paraformaldehyde, 204
- Paralysis  
 femoral, 166–7  
 ischiadic, 164–5  
 obturator, 165–6  
 peroneal, 167–8  
 radial, 163–4  
 tibial, 168–9
- Particle size of feed, 61–2
- Pastern bone, 242
- Pasture managed cattle, 5–6, 107–19  
 milking yard, 111  
 nutrition and lameness, 111–17  
 trackways, 108–10
- Pastures  
 changes in quality, 112  
 characteristics of, 112  
 grass  
 crude protein in, 113–14  
 oligofructoses in, 113  
 mineral status, 116–17
- Pathetic appearance, 157, 158
- Pedal bone, 242, 244, 246  
 displacement, 51  
 fractures, 32, 264–6  
 pathophysiological, 266–8  
 traumatic, 264–6  
 use of methyl methacrylate in, 269–70  
 rotation, 50  
 sinking, 50, 51, 98  
 support system, 243
- Pedal joint, 242–3, 244, 247  
 abscess *see* Retroarticular abscess drainage, 261  
 septic arthritis, 95, 252–61  
 synovial space, 244
- Pedline, 186
- Peripheral neuropathies, 163–9  
 femoral paralysis, 166–7  
 ischiadic paralysis (sciatic paralysis), 164–5  
 obturator paralysis, 165–6  
 peroneal paralysis, 167–8  
 radial paralysis, 163–4  
 tibial paralysis, 168–9
- Peroneal paralysis, 167–8
- Peroneus tertius muscle rupture, 288
- Personal space, 72
- Pesticides, 122
- PH, 55
- Phlegmon, 101
- Phlegmona interdigitale *see* Foot rot
- Phosphorus  
 and foot health, 130  
 recommended dietary level, 127
- Physical effective factor, 111
- Physical fiber, 60
- Physical restraint, 188
- Pincers, 193  
 hydraulic, 193, 194
- Pododermatitis aseptica diffusa *see* Subacute laminitis
- Pododermatitis septica circumscripta *see* Sole ulcer
- Poor feed delivery, 66
- Post legged, 33
- Posture, 151
- Potassium, recommended dietary level, 127
- Poultice, 285
- Primary deficiency, 125
- Protected minerals, 125
- Protein, 64  
 in pasture grass, 113–14
- Protexin Hoof Care, 187
- Proximal annular ligament, 245, 246
- Proximal interphalangeal joint, 242
- Puffy feet, 38, 65, 138
- Puffy hock, 284, 285
- Push-up, 55
- 
- Q**
- Quadriceps femoris wasting, 167
- 
- R**
- Radial paralysis, 163–4
- Rear legs  
 rear view, 146  
 set, 145–6
- Regional anesthesia, intravenous, 250

## 310 Index

- Regional intravenous antibiotic perfusion, 252
- Replacement stock, 134–40
- beef bulls, 138
  - early calving, 135–6
  - exercise and flooring, 138
  - heifer nutrition, 137
  - social confrontation, 137
  - weight and weight gain, 136–7
- Resting, importance of, 71
- Restraint, 188–9
- chemical, 188
  - physical, 188
- Retroarticular abscess, 95, 201, 261–3
- description, 261
  - differential diagnosis, 261
  - treatment, 262–3
- Risk factors, 299, 300–1
- Rotation, 50
- Rotational grazing, 112–13
- Rubber floors, 78, 79
- Rumen
- acidosis, 114–15
  - microorganism population, 59
  - papillae development, 59
  - stellate scar, 57
- Rumen buffers, 116
- Rumen modifiers, 64, 115–16
- Rumenocentesis, 57, 58
- 
- S**
- Sandcracks *see* Vertical fissures
- SARA *see* Subacute ruminal acidosis
- Scald *see* Interdigital dermatitis
- Sciatic paralysis *see* Ischiadic paralysis
- Screen particle separators, 61
- Secondary deficiency, 125
- Selenium
- and foot health, 129–30
  - recommended dietary level, 127
- Semi-pastoral management systems, 115
- Septic pedal arthritis, 95, 252–61
- description, 252–3
  - differential diagnosis, 261
  - radiographic features, 253
  - treatment options, 254–61
    - amputation of digit, 254–5
    - arthrodesis, 255–61
- Septic tenosynovitis, 264
- Serous tarsitis, 284
- Set stocking, 107
- Severity scoring of lameness, 35
- Shoes, 195–7
- Shoof, 195, 223
- Shot gun supplementation, 126
- Slatted floors, 79, 81
- Slippage, 145
- Slipper foot, 49
- Slug feeding, 55, 107, 113
- Slurry heel *see* Interdigital dermatitis
- Social confrontation, 71–2, 137
- Sodium, and foot health, 130
- Sole, 17–18, 244
- abscess, 224–5
  - axial wall fissures, 232–3
  - bruising, 221–4
  - double, 102–4
  - foreign bodies, 224–5
  - hardship grooves, 39, 233–7
  - overloading, 47, 171, 172, 221
  - thickness, 176
  - vertical fissures, 228–32
  - young animal, 172
- Solear surface, 241
- Sole ulcer (pododermatitis septica circumscripta), 84–9, 245
- causes, 86–8
  - symptoms, 85
  - treatment, 88–9
- Space sharing, 75
- Spastic paresis (Elso heel), 292–3
- Spastic syndrome, 290–2
- Spinal cord dysfunction, 279–81
- ankylosing spondylitis, 279
  - broken back, 279–80
  - degenerative arthropathy, 280–1
  - degenerative joint disease, 280–1
  - osteochondritis dissecans, 280–1
  - osteochondrosis, 280–1
  - pressure on spinal cord, 280
- Spirocheta* spp., 202, 208
- Spondylitis, 278
- Spread-eagled position, 166
- Stable foot rot *see* Interdigital dermatitis
- Stalls
- dimensions and features, 74–5
  - floor surfaces, 77
  - individual, 78
  - traditional, 78
- Stance, 29
- Staphylococcus* spp., 202
- Stature, 147
- Steaming up *see* Lead feeding
- Stifle joint, 247
- see also* Cruciate ligament
- Stratum basale, 10, 11
- Stratum germinativum, 52
- Stratum granulosum, 10
- Stratum spinosum, 10, 52
- Streptococcus pyogenes*, 202
- Stress, 48, 303–4
- Stride, 29
- Strip grazing, 113
- Subacute laminitis, 38–40
- cause, 39
  - description, 38–9
  - treatment, 40
- Subacute ruminal acidosis, 44–5, 56–8
- early clinical signs, 56, 57
  - economic impact, 56
  - epistaxis, 57
  - milk fat:protein inversion, 57
  - rumen fluid analysis, 57
  - stellate scarring, 57
- Subclinical laminitis, 40–9
- cause, 44
  - control, 49
  - description, 40–3
  - etiology and pathogenesis, 44–7
  - mechanical risk factors, 47–8
  - and sole ulcer, 86
  - treatment, 48
- Sulfate, in water, 121
- Superficial flexor tendon, 244
- Super foul, 201
- Swinging leg lameness, 31
- Synovial space, 244
- 
- T**
- Tarsal cellulitis, 284–6
- Tarsal hydrarthrosis, 284
- Tendons
- contracted, in calves, 289
  - deep flexor, 244
  - resection of, 257–61
  - gastrocnemius, rupture, 287–8
  - infraspinal, 249
  - superficial flexor, 244
- Thimble, 235
- Tibial paralysis, 168–9
- Toe abscess, 96, 100–2, 245
- causes, 101–2
  - control, 102
  - description, 100
  - treatment, 102
- Toe ulcer, 95–100, 245
- cause, 98
  - control, 100
  - description, 96–8
  - protection of, 270, 271
  - treatment, 98–9
- Total mixed ration, 66–7
- sorting, 62
- Tower silos, 64
- Toxic cow, 156
- Trace elements
- dietary levels, 127
  - in feed, 127–8
- Tracking, 29
- Trackways, 107, 108–10
- design and construction, 109
  - good vs poor, 109
  - maintenance, 109–10
  - management, 108–9
  - width and herd size, 109

Transition period, 55  
*Treponema* spp., 211  
 Trochanter major, 248

---

## U

Ulcer  
   sole, 84–9, 245  
   toe, 95–100, 245, 270, 271  
 Ultrasonography, 160  
 Under-run heel, 105  
 Upper limb disorders, 278–94  
   musculoskeletal dysfunction,  
   281–93  
   carpal hygroma, 286  
   contracted tendons in calves,  
   289  
   cruciate ligament rupture, 283  
   gastrocnemius muscle/tendon  
   rupture, 287–8  
   hematoma, 286–7  
   hip dislocation (coxofemoral  
   luxation), 281–3  
   knee cap dislocation (patellar  
   luxation), 283–4  
   neonatal polyarthritis, 289–90  
   peroneus tertius muscle rupture,  
   288  
   serous tarsitis, 284  
   spastic paresis (Elso heel), 292–3

  spastic syndrome, 290–2  
   tarsal cellulitis, 284–6  
 spinal cord dysfunction, 279–81  
   ankylosing spondylitis, 279  
   broken back, 279–80  
   degenerative arthropathy,  
   280–1  
   degenerative joint disease,  
   280–1  
   osteochondritis disicans,  
   280–1  
   osteochondrosis, 280–1  
   pressure on spinal cord, 280

---

## V

Vaccines  
   digital dermatitis, 213  
   foot rot, 204  
   interdigital dermatitis, 207  
 Ventilation, 81–2  
 Vertical fissures, 228–32  
   control, 232  
   description, 228–32  
 Veterinary practitioner, 296  
 Victory, 186  
 Vitamin A, 131  
 Vitamin D, 131  
 Vitamin E, 131  
 Volatile fatty acids, 59, 112

---

## W

Walk around, 299  
 Walking narrow, 31  
 Wall, 241, 244  
 Water, 120–4  
   availability of, 73  
   drinking behavior, 122–4  
   quality, 120–2  
 Water troughs, 123–4  
 Weaning grooves, 233–4  
 Weight and weight gain, 136–7  
 White line (zona alba), 19  
   abscess, 225–8  
 White line disease, 89–95, 245  
   causes, 89, 93–4  
   description, 89, 90–3  
   treatment, 94–5  
 World Holstein-Friesian Federation, 142  
 Wraps, 186–7

---

## Z

Zinc, 116  
   and foot health, 128  
   recommended dietary level, 127  
 Zinc methionine, 204  
 Zinc sulfate, 186  
 Zona alba *see* White line